



Product Catalog



Look inside for NEW products and information from OHAUS

Ingeniously Practical

Products at Work

The OHAUS product range is specifically designed to help maximize productivity, across every surface of the workspace. From the office to the warehouse, our Ingeniously Practical portfolio is packed with products made with your customers' needs in mind. Our industry-leading line of scales and balances offer the accuracy, speed, and peace of mind your customers need to Weigh It with ease, while our ever-growing line of laboratory instruments products allows them to Test It with the confidence they need. Introduced in 2017, the OHAUS line of laboratory equipment rounds out the ability to Do More in the lab, offering products ranging from mixers and shakers to clamps and supports – and everything in between.

*No matter what your customers' needs are, from research and development to fulfillment and receiving, you can depend on OHAUS for everything you need to let your customers' operations thrive. Don't stop at just measurement – **Do More.***



Laboratory Equipment
Mini Vortex Mixer
Wide selection of models to meet all mixing needs



Laboratory Equipment
Frontier™ 5000 Series Multi Pro
Powerful and versatile universal centrifuges for virtually every lab application



Laboratory Balances
Explorer® Analytical
Intelligent Performance No Matter How Difficult the Task



Laboratory Instruments
Starter 5000
Easy to use and intuitive benchtop pH meters

5,192
Product Offerings

274

Laboratory
Balances

361

Industrial
Scales

372

Laboratory
Equipment &
Instruments

2047

Calibration
Weights

2264

Accessories



Processing | Production | Quality Control | Quality Assurance

Inventory | Warehouse | Shipping | Receiving



Food Scales
Valor® 4000
Durable wash-down scales
with fast stability



Moisture Balances
MB120
Reliable and accurate moisture
analyzers



Bench Scales
New Defender® 5000
Bench scales from 5 to
1,000 lb for the toughest
jobs



Floor Scales
New Drum Scale
Durable floor scales for daily
industrial usage from 500 to
10,000 lb.

Contents

Laboratory Weighing

Selection Guide..... 1

Analytical & Precision Balances

Explorer® Semi-Micro.....2
Explorer® Analytical.....3
Explorer® Precision.....4
Explorer® Precision High Capacity.....6
Adventurer® Analytical.....7
Adventurer® Precision.....8
Pioneer® Semi-Micro.....10
Pioneer® Analytical.....11
Pioneer® Precision.....12
PR Series Precision.....13

Portable Balances

Scout® STX.....14
Scout® SPX.....15
Navigator® Series.....16
CS Series.....17
CL Series.....18
HH Series.....18
PS Series.....19
YA Series.....19

Moisture Analyzers

MB120.....20
MB90.....21
MB27.....22
MB23.....23

Mechanical Scales & Balances

D500M.....24
Heavy Duty Solution.....24
Field Test.....25
Triple Beam Pro®.....25
Triple Beam 700 Series.....26
Triple Beam Junior.....27
Triple Beam Dial-O-Gram® 1600 Series.....27
Dial-O-Gram® and Cent-O-Gram® 300 Series.....28
Harvard Junior.....28
Harvard Trip®.....29
School Balance.....29
Primer® Balance.....30
Spring Scales.....31
Pull Type Spring Scales.....31
Dial Type Spring Scales.....31
OHAUS Reloading Scales.....32

Industrial Weighing

Selection Guide.....35

Floor Scales

Drum Scale.....36
VX Series.....37
VN Series.....38
VN Series Floor Scale Platforms.....38

Bench Scales

CKW Checkweigher.....39
Defender® 5000 Washdown - NEW.....40
Defender® 5000 WD Low Profile - NEW.....41
Defender® 5000 - NEW.....42
Defender® 5000 Low Profile - NEW.....44
Defender® 7000.....46
Defender® 7000 Low Profile.....48
Defender® 5000.....49
Defender® 5000 Low Profile.....51
Defender® 3000 Washdown.....52
Defender® 3000.....53

Defender® Digital Field Test.....54
ES Series.....55
SD Series.....56

Counting Scales

Ranger® 7000.....57
Ranger® Count 4000.....58
Ranger® Count 3000.....59

Compact Bench Scales

Ranger® 7000.....60
Ranger® 4000.....61
Ranger® 3000.....62
Valor® 7000.....63
FD Series.....64
Valor® 4000.....65
Valor® 3000.....66
Valor® 2000.....67
Valor® 1000.....68
Catapult® 1000.....68

Indicators

TD52.....69
T72XW.....70
T71XW.....71
T71P.....72
T51XW.....73
T51P.....74
T32XW.....75
T32M.....76
T31P.....77

Bench Scale Bases

CKW Bases.....78
Defender® WQ and WT Stainless Steel.....79
Defender® RQ and RT Series.....80
Defender® W Series Stainless Steel.....81
Defender® H Series Bases.....81
Defender® Q Series Bases.....82
Defender® V Series Stainless Steel.....82
Defender® B Series Bases.....83

Price Computing Scales

Aviator 7000.....84

Calibration Weights

Overview.....87
ASTM Weights & Weight Sets.....88
OIML Weights & Weight Sets.....97
NIST Weights & Weight Sets.....102

Printers.....105

Weighing Accessories.....106

Laboratory Equipment

Centrifuges

Frontier™ Series.....111
Frontier™ Series Rotors & Accessories.....115

Open Air Shakers

Selection Guide.....127
Light Duty Orbital Shakers.....129
Extreme Environment Shakers.....132
Heavy Duty Orbital Shakers.....133
Rocking & Waving Shakers.....139
Reciprocating Shakers.....143

Incubating & Incubating Cooling Shakers

Selection Guide.....144
Incubating Cooling Thermal Shakers.....146
Incubating Light Duty Orbital Shakers.....148
Incubating Cooling Orbital Shakers.....150
Incubating Rocking & Waving Shakers.....153
Open Air, Incubating, Incubating Cooling Shakers Accessories.....155

Vortex Mixers

Mini Vortex Mixers.....163
Heavy-Duty Vortex Mixers.....167
Microplate Vortex Mixers.....169
Multi-Tube Vortex Mixers.....172

Dry Block Heaters

Dry Block Heaters.....175
2 Block Dry Block Heaters with Lid.....177

Hotplates & Stirrers

Mini Hotplates & Stirrers.....181

Bead Mill Homogenizers

HT Lysing Bead Mill Homogenizers.....182

LabJaws Clamps & Supports

Multi-Purpose Clamps.....184
Specialty Clamps.....189
Connectors & Holders.....195
Rods, Frames, & Supports.....198
Flow Control Clamps.....210
Misc. Non-Electrical Products.....211

Laboratory Instruments

Selection Guide.....213

pH/ORP/Conductivity/ DO Measurement /TDS/Salinity Measurement

Starter 5000 pH Bench.....214
Starter 3100M Bench.....215
Starter 3100 pH Bench.....216
Starter 3100C Conductivity Bench.....217
Starter 2100 pH Bench.....218
Starter 300 pH Portable.....219
Starter 300C Conductivity Portable.....220
Starter 300D DO Portable.....221
Starter 400D DO Portable.....222
Starter Pen Meters.....223
Starter Electrodes.....224

Equipment & Instrument Accessories.....225

Terms and Conditions of Sale.....230

OHAUS MAP Policy.....231

Dealer Resources.....232

Dealer Support.....233

Icon Legend.....234

Laboratory Weighing



From our powerhouse flagship Explorer balance to our rugged and practical Pioneer, OHAUS has a wide variety of semi-micro, analytical, precision, high-capacity, and moisture balances that are ideal for use in almost every area of your laboratory – and beyond.



Laboratory Balance Selector Guide

	Analytical Balances				Precision Balances				Portables			Moisture Analyzers			
	Explorer Semi-Micro	Explorer	Adventurer	Pioneer	Explorer	Adventurer	Pioneer	PR Series	Navigator	Scout	CS/CL	MB120	MB90	MB27	MB23
Weighing Capacity Range	51 g - 220 g	120 g - 320 g	120 g - 320 g	80 g - 220 g	220 g - 35000 g	220 g - 8200 g	160 g - 4200 g	320g - 5200g	210 g - 20 kg	120 g - 8200 g	200 g - 5000 g	120 g	90 g	90 g	110 g
Readability Range	0.01 mg	0.1 mg	0.1 mg	0.1 mg	0.001 g - 0.1 g	0.001 g - 0.1 g	0.001 g - 0.1 g	0.001 g - 0.1 g	0.01 g - 1 g	0.001 g - 1 g		0.001 g	0.001 g	0.001 g	0.01 g
Parts Counting	●	●	●	●	●	●	●	●	●	●					
Percent Weighing	●	●	●	●	●	●	●	●	●	●		●	●	●	
Custom Unit -Factor Entry	●	●	●	●	●	●	●								●
Checkweighing	●	●	●		●	●			●	●					
Dynamic Weighing	●	●	●	●	●	●	●					●			
Gross/Net/Tare	●	●	●		●	●									
Totalization	●	●	●		●	●			●	●				●	●
Statistics	●	●	●		●	●									
Differential Weighing	●	●			●										
Filling	●	●			●										
Density Determination	●	●	●	●	●	●	●					●			
Pipette Calibration	●	●			●*										
High Point	●	●			●										
Display Hold			●			●			●	●					
Formulation	●	●	●		●	●									
Ingredient Costing		●			●										
Battery Power					●*				●	●	●				
Backlight LCD				●			●	●	●	●					
LCD				●			●		●	●	●				
Color Graphics Display	●	●	●		●	●						●*			
Touchscreen	●	●	●		●	●						●*			
Keys			●	●		●	●					●			
Multi Languages	●	●	●		●	●						●*			
RS232	●	●	●	●	●	●	●	●	○	○					
USB - Host	●	●	●		●	●									
USB - Device	●	●	●	●	●	●	●	○	○	○					
Ethernet	○	○			○			○	○	○					
GLP / Time / Date	●	●	●	●	●	●	●		○	●*					
Bluetooth							●*			●					
Internal Calibration	●*	●*	●*	●*	●*	●*	●*	●		●*					
External Calibration	●	●	●	●	●	●	●		●	●	●				
AutoCal	●*	●*	●*		●*	●*		●							
Below Balance Weighing	●	●	●	●	●	●	●			●					
NTEP Certified or Measurement Canada Approved		●*	●*		●*	●*			●*						
Page No.	2	3	7	10	4	8	12	13	16	14	17	20	21	22	23

○ Optional *on specific models

Explorer® Semi-Micro Balances

Built for Sophisticated, Professional Weighing

- Geared for high performance with up to 0.01 mg readability and capacities up to 220 g. The AutoCal™ Internal Calibration system ensures accuracy of results in applications that require high precision.
- Equipped with a color touchscreen display that enhances the user experience. In addition, touchless sensors, automatic draftshield doors (on select models) and ionizer ensure the integrity of results.
- SmarText™ 2.0 software, intuitive icon-based navigation, 99 item library, 10 user profiles and below minimum sample weight indication all combine to provide an easy yet efficient weighing experience.



- Application** Weighing, Percent Weighing, Parts Counting, Checkweighing, Dynamic/Animal Weighing, Filling, Totalization, Formulation, Differential Weighing, Density Determination, Peak Hold, Pipette Adjustment, SQC
- Display** Full-color VGA graphic display (5.7 in. diagonal), 4-wire resistive touchscreen. QWERTY keyboard and numeric keypad to quickly input GLP and GMP data and other application data
- Operation** AC Adapter (Included)
- Communication** RS232, USB Host, USB Device, optional Ethernet (accessory sold separately) . GLP/GMP data output with real-time clock.
- Construction** Metal base, ABS top housing, stainless steel pan, anti-static glass draftshield with flip-top door, replaceable in-use cover, automatic door as option models
- Design Features** AutoCal™ fully automatic internal calibration system included on all models, fast stabilization time, four touchless sensors, built-in ionizer with automatic door models, 14 operating languages, save to USB function, menu lock switch, security bracket, integral weigh below hook for below balance weighing applications, removable stainless steel weighing platform, stability indicator, overload and underload indicators, auto standby.



Model	Auto Door	Capacity	Readability	Pan Size	Item No.
EX125D		51 g; 120 g	0.01 mg; 0.1 mg	Ø 3.14 in / Ø 80 mm	30139510
EX125		120 g	0.01 mg		30139511
EX225D		120 g; 220 g	0.01 mg; 0.1 mg		30139512
EX225D/AD	•				30139513
EX225/AD	•	220 g	0.01 mg		30139514

Accessories	Item No.
Printer, Impact, SF40A, AM	30064203
Static Ionizer, ION-100A, AM	30130302
USB Extension Cable, EX	30217067
Pipette Adjustment Kit, EX Semi-Micro	30252145
Dust Cover, Balance with Draft Shield	30093334
Auxiliary Display, AD7-RS	30472064
Paper Roll, (1), CBM910	80251932
Ink Ribbon, CBM910	80251933
Cable, RS232,CBM910-AV DV EX MB PA TxxP	80252571
Density Kit, Solids	80253384

Accessories	Item No.
Cable, 25 Pin-9 Pin, PC-TxxP	80500524
Cable, RS232, IBM 9P, AV DV MB Ranger	80500525
Anti-Theft Device, MB AX EX	80850043
Ethernet Kit, EX EX-HiCap	83021082
Cable, RS422, Extension, EX EX-HiCap	83021083
Cable, USB, Type A-B	83021085



Explorer® Analytical Intelligent Performance No Matter How Difficult the Task

- A large color touchscreen gives access to the advanced application modes and icon-driven application software features such as user manager, library, and minimum weight indication.
- Explorer features fast stabilization times, optimized linearity and repeatability specifications, enhanced vibration filtering as well as AutoCal™ calibration to ensure accuracy.
- The draftshield provides easy entry to the weighing chamber through the flip or sliding top door and the top-mounted side doors which can be automatically controlled on /AD models.



- Application** Weighing, Parts Counting, Percent Weighing, Checkweighing, Animal/Dynamic Weighing, Filling, Totalization/Statistics, Formulation, Differential Weighing, Density Determination, Peak Hold, Ingredient Costing, Pipette Adjustment, SQC
- Display** 5.7" (145 mm) Full-color VGA graphic touchscreen display with user-controlled brightness
- Operation** AC adapter (included)
- Communication** RS232, USB Host, USB Device, optional Ethernet (accessory sold separately) . GLP/GMP data output with real-time clock.
- Construction** Modular design, metal base, ABS top housing, stainless steel pan, glass draftshield with top mounted side doors and flip/sliding top door, illuminated up-front level indicator, integral weigh below hook, security bracket, calibration lock, four touchless sensors, in-use cover
- Design Features** Selectable environmental filters, auto tare, user selectable span calibration points, software lockout and reset menu, user selectable communication settings and data print options, user definable project and user IDs, auto standby, 14 operating languages

Model	Auto Door	Capacity	Readability	Certified Readability	Pan Size	Item No.
EX124		120 g	0.1 mg	—	Ø 3.5 in / Ø 90 mm	83021331
EX124/AD	•					30061976
EX224		220 g				83021332
EX224/AD	•					30061977
EX324		320 g				83021335
EX324/AD	•		30061978			

Approved Model	Auto Door	Capacity	Readability	Certified Readability	Pan Size	Item No.
EX224N		220 g	0.1 mg	1 mg	Ø 3.5 in / Ø 90 mm	83021334
EX224N/AD	•					30061998
EX324N		320 g				83021337
EX324N/AD	•					30061999

Accessories	Item No.
Cable, RS9 M/F, 1.5 m	12122603
Printer, Impact, SF40A, AM	30064203
Cable, RS422, 9m, EX EX-HiCap	30078078
Dust Cover, Balance with Draft Shield	30093334
Auxiliary Display, AD7-RS	30472064
Printer, Thermal, STP-103, US	80251992
Cable, RS232, CBM910-AV DV EX MB PA TxxP	80252571
Cable, ST103-AV DV EX MB PA TxxP	80252581
Density Kit, Solids	80253384
Cable, 25 Pin-9 Pin, PC-TxxP	80500524
Cable, RS232, IBM 9P, AV DV MB Ranger	80500525

Accessories	Item No.
Adapter, 25 Pin-9 Pin, SF42 SRP275	80500572
Anti-Theft Device, MB AX EX	80850043
Software, Winwedge	80850080
Ethernet Kit, EX EX-HiCap	83021082
Cable, RS422, Extension, EX EX-HiCap	83021083
Cable, USB, Type A-B	83021085
Foot Switch Kit, EX EX-HiCap	83021086
In-Use-Cover, Terminal, EX	83033633

Accumulation	Checkweighing	Density Determination	Differential Weighing	Dynamic Weighing	Filling	Formulation	Gross/Net/Tare	Ingredient Costing	Audible Alerts	Auto Standby	Backlight	Environmental Filters	GLP Data Output	GMP/GLP	Internal Calibration	Level Indicator	Leveling Feet	NTEP Certified	
Parts Counting	Peak Hold	Percent Weighing	Pipette Calibration	SQC	Statistics	Totalization	Weighing	Multi-Language	Overload/Underload Indicators	Security Bracket	Software Lockout	Stability Indicator	Time/Date	Touch Screen	Touchless Sensors	Weigh Below Hook	Measurement Canada Approved		

Explorer® Precision

Intelligent Performance No Matter How Difficult the Task

- A large color touchscreen gives access to the advanced application modes and icon-driven application software features such as user manager, library, and minimum weight indication.
- Explorer features fast stabilization times, optimized linearity and repeatability specifications, enhanced vibration filtering and the choice of traditional calibration or AutoCal™ models.
- Explorer's sturdy modular design includes metal housing and a display that can be separated from the weighing base and tower- or wall-mounted for easy viewing in any workspace.

Application Weighing, Parts Counting, Percent Weighing, Checkweighing, Animal/Dynamic Weighing, Filling, Totalization/Statistics, Formulation, Differential Weighing, Density Determination, Peak Hold, Ingredient Costing, Pipette Adjustment, SQC, Statistics

Display 5.7" (145 mm) Full-color VGA graphic touchscreen display with user-controlled brightness

Operation AC adapter (included)

Communication RS232, USB Host, USB Device, optional Ethernet (accessory sold separately) . GLP/ GMP data output with real-time clock.

Construction Modular design, metal base, ABS top housing, stainless steel pan, glass draftshield with top mounted side doors and flip/sliding top door (1 mg models only), illuminated up-front level indicator, integral weigh below hook, security bracket, calibration lock, four touchless sensors, in-use cover

Design Features Selectable environmental filters, auto tare, user selectable span calibration points, software lockout and reset menu, user selectable communication settings and data print options, user definable project and user IDs, auto standby, 14 operating languages



1 mg Model

Model	AutoCal™	Draft Shield	Capacity	Readability	Certified Readability	Pan Size	Item No.	
EX223/E		•	220 g	1 mg	—	Ø 5.1 in / Ø 130 mm	30061979	
EX223	•						83021341	
EX423/E			420 g				30061980	
EX423	•						83021342	
EX623	•		620 g				83021348	
EX1103	•		1100 g				83021350	
EX2202/E		•	2200 g	0.01 g	—	7.5 in x 8 in / 190 mm x 200 mm	30061981	
EX2202	•						83021356	
EX4202/E			4200 g				30061982	
EX4202	•						83021357	
EX6202/E			6200 g				0.1 g	30061983
EX6202	•							83021360
EX6201/E	•							30061984
EX6201	•							83021361
EX10202	•		10200 g				0.01 g	83021362
EX10201	•						0.1 g	83021365

Explorer® Precision

Intelligent Performance No Matter How Difficult the Task

Approved Model	AutoCal™	Draft Shield	Capacity	Readability	Certified Readability	Pan Size	Item No.
EX423N	•	•	420 g	1 mg	0.01 g	Ø 5.1 in / Ø 130 mm	83021344
EX1103N	•		1100 g				83021352
EX4202N	•	•	4200 g	0.01 g	0.1 g	7.5 in x 8 in / 190 mm x 200 mm	83021359
EX10202N	•		10200 g				0.1 g
EX10201N	•			0.1 g			83021367

Accessories	Item No.
Cable, RS9 M/F, 1.5 m	12122603
Printer, Impact, SF40A, AM	30064203
Cable, RS422, 9m, EX EX-HiCap	30078078
USB Extension Cable, EX	30217067
Auxiliary Display, AD7-RS	30472064
Printer, Thermal, STP-103, US	80251992
Cable, RS232, CBM910-AV DV EX MB PA TxxP	80252571
Cable, ST103-AV DV EX MB PA TxxP	80252581
Density Kit, Solids	80253384
Cable, 25 Pin-9 Pin, PC-TxxP	80500524
Cable, RS232, IBM 9P, AV DV MB Ranger	80500525

Accessories	Item No.
Adapter, 25 Pin-9 Pin, SF42 SRP275	80500572
Anti-Theft Device, MB AX EX	80850043
Software, Winwedge	80850080
Ethernet Kit, EX EX-HiCap	83021082
Cable, RS422, Extension, EX EX-HiCap	83021083
Draft Shield Kit, EX	83021084
Cable, USB, Type A-B	83021085
Foot Switch Kit, EX EX-HiCap	83021086
Column Kit, EX	83021102
In-Use-Cover, Terminal, EX	83033633

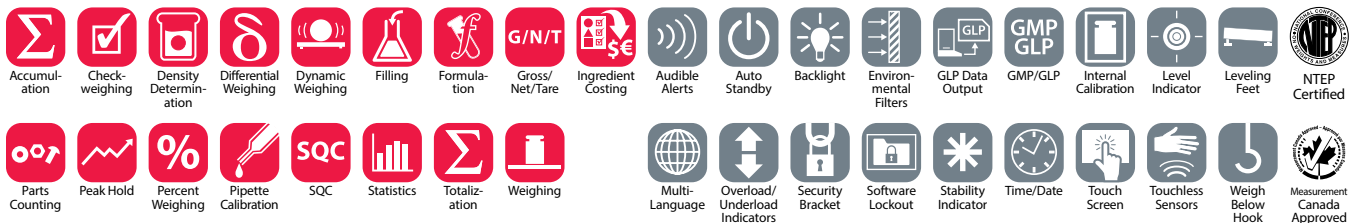

Explorer® Precision High Capacity

Intelligent Performance No Matter How Difficult the Task

- A large color touchscreen gives access to the advanced application modes and icon-driven application software features such as user manager, library, and minimum weight indication.
- 2-D shock protection and IP54 base enclosure protect the balance from damage, while the AutoCal™ automatic internal calibration system ensures performance.
- Explorer's sturdy modular design features a color touch display that can be separated from the weighing base as well as two programmable touch-free sensors and a large weighing pan.



Application Weighing, Parts Counting, Percent Weighing, Checkweighing, Animal/Dynamic Weighing, Filling, Totalization/Statistics, Formulation, Differential Weighing, Density Determination, Peak Hold, Ingredient Costing, SQC, Statistics

Display 5.7" (145 mm) Full-color VGA graphic touchscreen display with user-controlled brightness

Operation AC Adapter (included) or rechargeable battery (accessory sold separately)

Communication RS232, USB Host, USB Device, optional Ethernet (accessory sold separately) . GLP/ GMP data output with real-time clock.

Construction Modular design, IP54 metal base, die-cast top housing, stainless steel pan, up-front level indicator, integral weigh below hook, calibration lock, two touchless sensors, terminal housing in-use cover

Design Features Selectable environmental filters, auto tare, user selectable span calibration points, software lockout and reset menu, user selectable communication settings and data print options, user definable project and user IDs, auto standby, 14 operating languages



Model	Capacity	Readability	Pan Size	Item No.
EX12001	12000 g	0.1 g	14.8 in x 12.2 in 377 mm x 311 mm	30057099
EX24001	24000 g			30057100
EX35001	35000 g			30057101

Accessories	Item No.
Rechargeable Battery, EX-HiCap R71	30041295
Wheel Kit, Set(4), EX-HiCap	30041470
Printer, Impact, SF40A, AM	30064203
Cable, RS422, 9m, EX EX-HiCap	30078078
Column Kit, EX-HiCap	30078082
Auxiliary Display, AD7-RS	30472064
Printer, Thermal, STP-103, US	80251992
Cable, ST103-AV DV EX MB PA TxxP	80252581
Cable, 25 Pin-9 Pin, PC-TxxP	80500524

Accessories	Item No.
Cable, RS232, IBM 9P, AV DV MB Ranger	80500525
Anti-Theft Device, MB AX EX	80850043
Software, Winwedge	80850080
Ethernet Kit, EX EX-HiCap	83021082
Cable, RS422, Extension, EX EX-HiCap	83021083
Cable, USB, Type A-B	83021085
Foot Switch Kit, EX EX-HiCap	83021086
In-Use-Cover, Terminal, EX	83033633



Analytical & Precision Balances

Adventurer® Analytical Ready For Your Lab, Wherever That May Be

- Fast stabilization and reliable operation are enhanced by the AutoCal™ option to ensure solid weighing performance and accurate, repeatable results for standard laboratory applications.
- The wide viewing angle color touchscreen provides access to all of Adventurer's applications, while dual USB ports with GLP/GMP tracking capabilities assist in the monitoring and reporting of data.
- The two piece, top-mounted draftshield doors reduce the footprint of the doors in the rear of the balance when open, and open wide on both sides in order to provide ample room to place samples.



- Application** Weighing, Parts Counting, Percent Weighing, Checkweighing, Animal/Dynamic Weighing, Totalization/Statistics, Formulation, Density Determination, Display Hold
- Display** 4.3" (109 mm) Full-color VGA graphic touchscreen with user-controlled brightness
- Operation** AC adapter (included)
- Communication** RS232, USB Host, USB Device (included). GLP/GMP data output with real-time clock.
- Construction** Metal base, ABS top housing, stainless steel pan, glass draftshield with two piece top mounted side doors and sliding top door, illuminated up-front level indicator, integral weigh below hook, security bracket, calibration lock, full housing in-use cover
- Design Features** Selectable environmental filters, auto tare, user selectable span calibration points, software lockout and reset menu, user selectable communication settings and data print options, user definable project and user IDs, 9 operating languages



Model	AutoCal™	Capacity	Readability	Certified Readability	Pan Size	Item No.
AX124	•	120 g	0.1 mg	—	Ø 3.5 in / Ø 90 mm	30100600
AX124/E						30100601
AX224	•	220 g				30100602
AX224/E						30100603
AX324	•	320 g				30100604

Approved Model	AutoCal™	Capacity	Readability	Certified Readability	Pan Size	Item No.
AX224N	•	220 g	0.1 mg	1 mg	Ø 3.5 in / Ø 90 mm	30100630

Accessories	Item No.
Ink Ribbon, SF40A SF42A	12120798
Paper Roll, Set (2), 57.5mm, SF40A	12120799
Cable, RS9 M/F, 1.5 m	12122603
Printer, Impact, SF40A, AM	30064203
Dust Cover, Balance with Draft Shield	30093334
SP In-Use-Cover wo DS AX	30111777
SP In-Use-Cover DS AX	30111792
Auxiliary Display, AD7-RS	30472064

Accessories	Item No.
Paper Roll, (1), Thermal, STP103	80251931
Printer, Thermal, STP-103, US	80251992
Cable, ST103-AV DV EX MB PA TxxP	80252581
Density Kit, Solids	80253384
Cable, 25 Pin-9 Pin, PC-TxxP	80500524
Cable, RS232, IBM 9P, AV DV MB Ranger	80500525
Anti-Theft Device, MB AX EX	80850043
Cable, USB, Type A-B	83021085

Accumulation

Checkweighing

Density Determination

Display Hold

Dynamic Weighing

Formulation

Gross/Net/Tare

Backlight

Environmental Filters

GLP Data Output

GMP/GLP

Internal Calibration

Level Indicator

Leveling Feet

Multi-Language

NTEP Certified

Parts Counting

Percent Weighing

Statistics

Totalization

Weighing

Overload/Underload Indicators

Security Bracket

Software Lockout

Stability Indicator

Time/Date

Touch Screen

Weigh Below Hook

Measurement Canada Approved

Adventurer® Precision

Ready For Your Lab, Wherever That May Be

- Fast stabilization and reliable operation are enhanced by the AutoCal™ option to ensure solid weighing performance and accurate, repeatable results for standard laboratory applications.
- The wide viewing angle color touchscreen provides access to all of Adventurer's applications, while dual USB ports with GLP/GMP tracking capabilities assist in the monitoring and reporting of data.
- The 1 mg models have a two piece, top-mounted draftshield with doors that open wide, providing ample room for sample placement, while the 0.01 g and 0.1 g models feature large weighing pans.

- Application** Weighing, Parts Counting, Percent Weighing, Checkweighing, Animal/Dynamic Weighing, Totalization/Statistics, Formulation, Density Determination, Display Hold
- Display** 4.3" (109 mm) Full-color VGA graphic touchscreen with user-controlled brightness
- Operation** AC adapter (included)
- Communication** RS232, USB Host, USB Device (included), GLP/GMP data output with real-time clock.
- Construction** Metal base, ABS top housing, stainless steel pan, glass draftshield with two piece top mounted side doors and sliding top door (1 mg models only), illuminated up-front level indicator, integral weigh below hook, security bracket, calibration lock, full housing in-use cover
- Design Features** Selectable environmental filters, auto tare, user selectable span calibration points, software lockout and reset menu, user selectable communication settings and data print options, user definable project and user IDs, 9 operating languages



Model	AutoCal™	Draft Shield	Capacity	Readability	Certified Readability	Pan Size	Item No.
AX223	•	•	220 g	1 mg	—	Ø 5.1 in / Ø 130 mm	30100605
AX223/E							30100606
AX423	•		420 g				30100607
AX423/E							30100608
AX523	•		520 g				30100609
AX523/E							30100610
AX622	•	•	620 g	0.01 g	—	7.7 in x 6.9 in / 195 mm x 175 mm	30122632
AX422/E			420 g				30127981
AX822/E			820 g				30127983
AX1502	•		1520 g				30100611
AX1502/E							30100612
AX2202	•		2200 g				30100613
AX2202/E							30100614
AX4202	•		4200 g				30100615
AX4202/E							30100616
AX5202	•		5200 g				30100617
AX2201/E			2200 g				30248912
AX4201	•		4200 g				30122634
AX4201/E							30122635
AX8201	•		8200 g				30100618
AX8201/E			30100619				

Adventurer® Precision

Ready For Your Lab, Wherever That May Be

Approved Model	AutoCal™	Draft Shield	Capacity	Readability	Certified Readability	Pan Size	Item No.
AX223N/E		•	220 g	1 mg	0.01 g	Ø 5.1 in / Ø 130 mm	30100631
AX423N	•		420 g				30100632
AX423N/E			520 g				30100633
AX523N/E			620 g				30100634
AX622N/E		•	620 g	0.01 g	0.1 g	7.7 in x 6.9 in / 195 mm x 175 mm	30100635
AX1502N/E			1520 g				30100636
AX2202N/E			2200 g				30100637
AX4202N/E			4200 g				30122655
AX8201N/E			8200 g				0.1 g

Accessories	Item No.
Ink Ribbon, SF40A SF42A	12120798
Paper Roll, Set (2), 57.5mm, SF40A	12120799
Cable, RS9 M/F, 1.5 m	12122603
Printer, Impact, SF40A, AM	30064203
Dust Cover, Balance with Draft Shield	30093334
SP In-Use-Cover wo DS AX	30111777
SP In-Use-Cover DS AX	30111792
Auxiliary Display, AD7-RS	30472064

Accessories	Item No.
Paper Roll, (1), Thermal, STP103	80251931
Printer, Thermal, STP-103, US	80251992
Cable, ST103-AV DV EX MB PA TxxP	80252581
Density Kit, Solids	80253384
Cable, 25 Pin-9 Pin, PC-TxxP	80500524
Cable, RS232, IBM 9P, AV DV MB Ranger	80500525
Anti-Theft Device, MB AX EX	80850043
Cable, USB, Type A-B	83021085

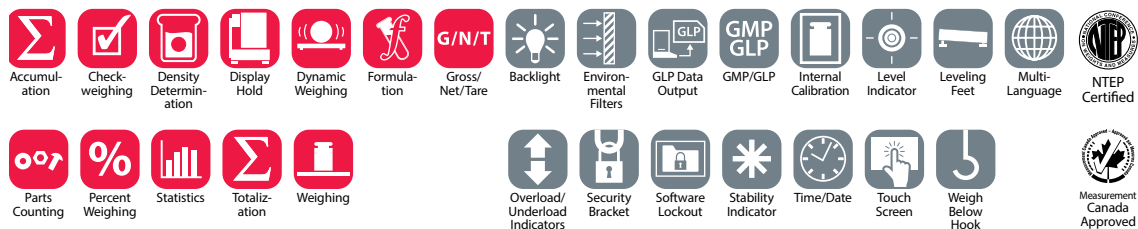

Pioneer® Semi-Micro

Combining Economy and High Performance for Essential Weighing

- The PX offers high accuracy and repeatability for essential weighing applications in laboratory, industrial and education settings at an economical price point.
- Featuring a cast metal lower housing, sub-pan and stainless steel weighing pan, the PX is durably constructed for versatile, long-term use.
- The PX features a second line display for additional information or guidance, a static removal bar for convenient grounding, and USB and RS232 connectivity for easy communication.



- Application** Basic Weighing, Parts Counting, Percent Weighing, Animal Weighing, Density Determination
- Display** Backlit Liquid Crystal Display (LCD); Second line display for additional information or guidance (dot matrix)
- Operation** AC adapter (included)
- Communication** RS232 and USB device (included); GLP/GMP data output with real-time clock
- Construction** Metal base, plastic top housing, removable stainless steel pan, glass draftshield, integrated weigh-below hook, security bracket, calibration lock and in-use cover
- Design Features** User-selectable environmental filters and brightness settings, auto-tare, auto-dim, user-selectable span calibration points, software lockout and reset menu, userselectable communication settings and data print options, user-definable project and user IDs, software overload/underload indicator, stability indicator, four operating languages



Model	InCal	Draftshield	Capacity (g)	Readability (g)	Certified Readability	Pan Size	Item No
PX85	•	•	82 g	0.01 mg	-	3.15 in / 80 mm	30475733
PX225D	•	•	82 g; 220 g	0.01 mg; 0.1 mg			30475734

Accessories	Item No.
Ink Ribbon, SF40A SF42A	12120798
Paper Roll, Set (2), 57.5mm, SF40A	12120799
Cable, RS9 M/F, 1.5 m	12122603
Printer, Impact, SF40A, AM	30064203
Dust Cover, Balance with Draft Shield	30093334
Auxiliary Display, AD7-RS	30472064
Paper Roll, (1), Thermal, STP103	80251931
Printer, Thermal, STP-103, US	80251992
Sinker Glass for Density Determination	83034024
Cable, USB, Type A-B	83021085
Anti-Theft Device	80850043
Static Ionizer, ION-100A, AM	30130302

Accessories	Item No.
Cable, RS232, CBM910-AV DV EX MB PA TxxP	80252571
Cable, ST103-AV DV EX MB PA TxxP	80252581
Density Kit, Solids	80253384
Cable, 25 Pin-9 Pin, PC-TxxP	80500524
Cable, RS232, IBM 9P, AV DV MB Ranger	80500525
Adapter, 25 Pin-9 Pin, SF42 SRP275	80500572
Software, Winwedge	80850080
In-Use-Cover, PX	30372546

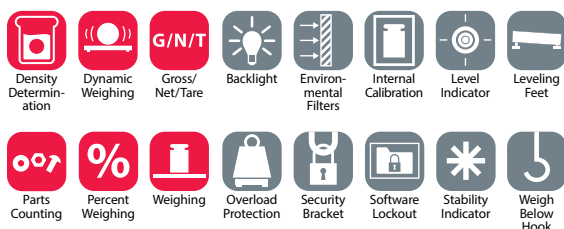

Pioneer® Analytical

Combining Economy and High Performance for Essential Weighing

- The PX offers high accuracy and repeatability for essential weighing applications in laboratory, industrial and education settings at an economical price point.
- Featuring a cast metal lower housing, sub-pan and stainless steel weighing pan, the PX is durably constructed for versatile, long-term use.
- The PX features a second line display for additional information or guidance, a static removal bar for convenient grounding, and USB and RS232 connectivity for easy communication.



- Application** Basic Weighing, Parts Counting, Percent Weighing, Animal Weighing, Density Determination
- Display** Backlit Liquid Crystal Display (LCD); Second line display for additional information or guidance (dot matrix)
- Operation** AC adapter (included)
- Communication** RS232 and USB device (included); GLP/GMP data output with real-time clock
- Construction** Metal base, plastic top housing, removable stainless steel pan, glass draftshield, integrated weigh-below hook, security bracket, calibration lock and in-use cover
- Design Features** User-selectable environmental filters and brightness settings, auto-tare, auto-dim, user-selectable span calibration points, software lockout and reset menu, userselectable communication settings and data print options, user-definable project and user IDs, software overload/underload indicator, stability indicator, four operating languages



Model	InCal	Draftshield	Capacity (g)	Readability (g)	Certified Readability	Pan Size	Item No
PX84/E		•	82 g	0.1 mg	-	3.54 in / 90 mm	30429845
PX84	•						30429837
PX124/E			120 g				30429846
PX124	•						30429838
PX224/E			220 g				30429847
PX224	•						30430053

Accessories	Item No.
Ink Ribbon, SF40A SF42A	12120798
Paper Roll, Set (2), 57.5mm, SF40A	12120799
Cable, RS9 M/F, 1.5 m	12122603
Printer, Impact, SF40A, AM	30064203
Dust Cover, Balance with Draft Shield	30093334
Auxiliary Display, AD7-RS	30472064
Paper Roll, (1), Thermal, STP103	80251931
Printer, Thermal, STP-103, US	80251992
Sinker Glass for Density Determination	83034024
Cable, USB, Type A-B	83021085
Anti-Theft Device	80850043
Static Ionizer, ION-100A, AM	30130302

Accessories	Item No.
Cable, RS232, CBM910-AV DV EX MB PA TxxP	80252571
Cable, ST103-AV DV EX MB PA TxxP	80252581
Density Kit, Solids	80253384
Cable, 25 Pin-9 Pin, PC-TxxP	80500524
Cable, RS232, IBM 9P, AV DV MB Ranger	80500525
Adapter, 25 Pin-9 Pin, SF42 SRP275	80500572
Software, Winwedge	80850080
In-Use-Cover, PX	30372546

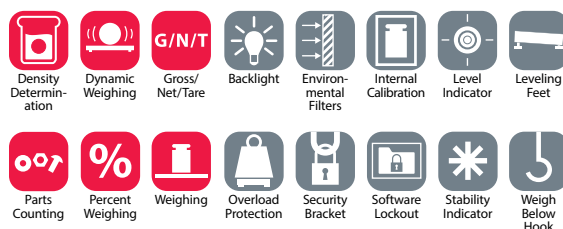

Pioneer® Precision

Combining Economy and High Performance for Essential Weighing

- The PX offers high accuracy and repeatability for essential weighing applications in laboratory, industrial and education settings at an economical price point.
- Featuring a cast metal lower housing, sub-pan and stainless steel weighing pan, the PX is durably constructed for versatile, long-term use.
- The PX features a second line display for additional information or guidance, a static removal bar for convenient grounding, and USB and RS232 connectivity for easy communication.



- Application** Basic Weighing, Parts Counting, Percent Weighing, Animal Weighing, Density Determination
- Display** Backlit Liquid Crystal Display (LCD); Second line display for additional information or guidance (dot matrix)
- Operation** AC adapter (included)
- Communication** RS232 and USB device (included); GLP/GMP data output with real-time clock
- Construction** Metal base, plastic top housing, removable stainless steel pan, glass draftshield, integrated weigh-below hook, security bracket, calibration lock and in-use cover
- Design Features** User-selectable environmental filters and brightness settings, auto-tare, auto-dim, user-selectable span calibration points, software lockout and reset menu, userselectable communication settings and data print options, user-definable project and user IDs, software overload/underload indicator, stability indicator, four operating languages

Model	InCal	Draftshield	Capacity (g)	Readability (g)	Certified Readability	Pan Size	Item No	
PX163/E		•	160 g	1 mg	-	4.72 in / 120 mm	30429848	
PX163	•						30429839	
PX323/E			320 g				30429849	
PX323	•						30429840	
PX523/E			520 g				30430057	
PX523	•		30430054					
PX1602/E		•	1600 g	0.01 g		-	7.09 in / 180 mm	30430058
PX1602	•							30430055
PX2202/E			2200 g					30429850
PX2202	•							30429841
PX3202/E			3200 g		30429851			
PX3202	•			30429842				
PX4202/E			4200 g	30429852				
PX4202	•			30429843				
PX2201/E			2200 g	0.1 g	30430059			
PX2201	•				30430056			
PX4201/E		4200 g	30429853					
PX4201	•			30429844				

Accessories	Item No.
Ink Ribbon, SF40A SF42A	12120798
Paper Roll, Set (2), 57.5mm, SF40A	12120799
Cable, RS9 M/F, 1.5 m	12122603
Printer, Impact, SF40A, AM	30064203
Dust Cover, Balance with Draft Shield	30093334
Auxiliary Display, AD7-RS	30472064

Accessories	Item No.
Paper Roll, (1), Thermal, STP103	80251931
Printer, Thermal, STP-103, US	80251992
Sinker Glass for Density Determination	83034024
Cable, USB, Type A-B	83021085
Anti-Theft Device	80850043
Cable, RS232, CBM910-AV DV EX MB PA TxxP	80252571
Cable, ST103-AV DV EX MB PA TxxP	80252581
Density Kit, Solids	80253384
Cable, 25 Pin-9 Pin, PC-TxxP	80500524
Cable, RS232, IBM 9P, AV DV MB Ranger	80500525
Adapter, 25 Pin-9 Pin, SF42 SRP275	80500572
Software, Winwedge	80850080
In-Use-Cover, PX	30372546



PR Series Precision Economical Balances For Legal-For-Trade Applications

- All models are NTEP certified and Measurement Canada approved, making them suitable for direct sale applications and are capable of weighing in grams, carats, ounces, and more.
- The PR can be easily connected to point-of-sale or other computer systems or printers via its standard RS-232 port, or via USB or Ethernet through an interface kit.
- Featuring an easy-to-read, brightly-lit display and a simple user interface, the PR is well-constructed for long-term use, and delivers competitive performance at an economical price.

- Application** Basic Weighing, Parts Counting, Percent Weighing
- Display** Backlit liquid crystal display (LCD)
- Operation** AC adapter (included)
- Communication** RS-232 port (standard), USB or Ethernet (via an interface kit)
- Construction** ABS housing, stainless steel pan, glass draftshield (milligram models only), weigh below hook, security lock interface, LFT lockout switch
- Design Features** User-selectable environmental filters and brightness settings, auto-tare, auto-dim, user-selectable span calibration points, software lockout and reset menu, user-selectable communication settings and data print options, software overload/underload indicator, stability indicator



Available Early/Mid 2019

Model	Class	InCal	Draftshield	Capacity (g)	Readability (g)	Certified Readability	Pan Size	Item No
PR323N/E	II	.	.	320 g	1 mg	0.01 g	4.72 in / 120 mm	30455605
PR523N/E	II			520 g				30455606
PR523N	II			520 g				30452494
PR322N/E	II	.	.	320 g	0.01 g	0.1 g	7.09 in / 180 mm	30515026
PR522N/E	II			520 g				30515027
PR822N/E	III			820 g				30455607
PR2202N/E	II			2200 g				30455668
PR5202N/E	II			5200 g				30455670
PR2201N/E	II	.	.	2200 g	0.1 g	1 g	7.09 in / 180 mm	30455671
PR5201N/E	II			5200 g				30515038
PR6201N/E	III			6200 g				30455673

Accessories	Item No.
Ink Ribbon, SF40A SF42A	12120798
Paper Roll, Set (2), 57.5mm, SF40A	12120799
Cable, RS9 M/F, 1.5 m	12122603
Printer, Impact, SF40A, AM	30064203
Auxiliary Display, AD7-RS	30472064
Paper Roll, (1), Thermal, STP103	80251931
Printer, Thermal, STP-103, US	80251992
Anti-Theft Device	80850043

Accessories	Item No.
Cable, RS232, CBM910-AV DV EX MB PA TxxP	80252571
Cable, ST103-AV DV EX MB PA TxxP	80252581
Cable, 25 Pin-9 Pin, PC-TxxP	80500524
Cable, RS232, IBM 9P, AV DV MB Ranger	80500525
Adapter, 25 Pin-9 Pin, SF42 SRP275	80500572
Software, Winwedge	80850080



Scout® STX Touchscreen

Setting New Standards in Laboratory & Industrial Weighing - The Next Generation of Scout Balances

- Large, resilient color touchscreen allows for effortless operation of the Scout through its informative icon-driven menu structure, guiding the user through every step of the weighing application.
- Stabilization time as fast as 1 sec means increased productivity in your facility. Equipped with advanced weighing technology, the Scout also ensures repeatable and reliable weighing results.
- Integrated superior overload protection system rated at 10 times the capacity protects the balance in rugged and demanding environments. The space-saving, slim design allows for stackable storage.

Application Weighing, Parts Counting, Percent Weighing, Checkweighing, Animal/Dynamic Weighing, Totalization, Density Determination, Display Hold, Mole Weighing

Display 4.3" (109 mm) full-color VGA graphic touchscreen display with user-controlled brightness

Operation AC adapter (included) or 4 AA batteries (not included)

Communication RS232, USB Host, USB Device, Ethernet or Bluetooth® (available as accessories)

Construction ABS housing, stainless steel pan, ABS draftshield (1 mg models only), weigh below hook, transportation lock, manual calibration lock switch, security slot, adjustable leveling feet, illuminated up-front level indicator

Design Features Stability indicator, stackable design with included stacking and storage cover (excluding 1 mg models), mechanical and software overload/underload protection, low battery indicator, auto shut-off, auto tare, span calibration mass included on models up to 620 g capacity



Model	Capacity	Readability	Pan Size	Item No.	
STX123	120 g	0.001 g	Ø 3.7 in / Ø 93 mm	30253005	
STX223	220 g			30253006	
STX222	220 g			30253007	
STX422	420 g	0.01 g	Ø 4.7 in / Ø 120 mm	30253008	
STX622	620 g			30253009	
STX1202	1200 g			5.5 in x 6.7 in / 140 mm x 170 mm	30253010
STX2202	2200 g				30253011
STX421	420 g				30253012
STX621	620 g	0.1 g	Ø 4.7 in / Ø 120 mm	30253013	
STX2201	2200 g			30253014	
STX6201	6200 g			5.5 in x 6.7 in / 140 mm x 170 mm	30253015
STX8200	8200 g				30253016

Accessories	Item No.
Printer, Impact, SF40A, AM	30064203
RS232 Kit, STX SPX ST3100M	30268982
USB Kit, Host, STX SPX	30268983
USB Kit, Device, STX SPX ST3100M	30268984
Bluetooth Kit, STX SPX	30268985
Ethernet Kit, STX SPX	30268986

Accessories	Item No.
Stacking & Storage Cover, x6, STX SPX	30268987
Stacking & Storage Cover, x1, STX SPX	30268988
Density Kit, STX	30269020
Anti-Theft Device, MB AX EX STX SPX	80850043
Carrying Case, Scout	30269021



Scout® SPX

Setting New Standards in Laboratory & Industrial Weighing - The Next Generation of Scout Balances

- Combined with a simplified 4 button operation, the Scout's large backlit display increases readability in low light working conditions, and is easier to view from a distance.
- Integrated superior overload protection and impact-resistant pan support safeguard against shock and overloading the balance in rugged and demanding environments.
- Stabilization time as fast as 1 sec and advanced weighing technology lead to improved productivity in your facility. Increased capacity unlocks a wider range of weighing applications.

Application Weighing, Parts Counting, Percent Weighing, Checkweighing, Totalization, Display Hold

Display Liquid crystal display (LCD) with backlight

Operation AC adapter (included) or 4 AA batteries (not included)

Communication RS232, USB Host, USB Device, Ethernet or Bluetooth® (available as accessories)

Construction ABS housing, stainless steel pan, ABS draftshield (1 mg models only), weigh below hook, transportation lock, manual calibration lock switch, security slot, adjustable leveling feet, illuminated up-front level indicator

Design Features Stability indicator, stackable design with optional stacking & storage cover (excluding 1 mg models), mechanical and software overload/underload protection, low battery indicator, auto shut-off, auto tare, span calibration mass included on models up to 620 g capacity



Model	Capacity	Readability	Pan Size	Item No.
SPX123	120 g	0.001 g	Ø 3.7 in / Ø 93 mm	30253017
SPX223	220 g			30253018
SPX222	220 g			30253019
SPX422	420 g	0.01 g	Ø 4.7 in / Ø 120 mm	30253020
SPX622	620 g			30253021
SPX1202	1200 g			30253022
SPX2202	2200 g	0.1 g	5.5 in x 6.7 in / 140 mm x 170 mm	30253023
SPX421	420 g			30253024
SPX621	620 g			30253025
SPX2201	2200 g	1 g	5.5 in x 6.7 in / 140 mm x 170 mm	30253026
SPX6201	6200 g			30253027
SPX8200	8200 g			30253028

Accessories	Item No.
Printer, Impact, SF40A, AM	30064203
RS232 Kit, STX SPX ST3100M	30268982
USB Kit, Host, STX SPX	30268983
USB Kit, Device, STX SPX ST3100M	30268984
Bluetooth Kit, STX SPX	30268985
Ethernet Kit, STX SPX	30268986

Accessories	Item No.
Stacking & Storage Cover, x6, STX SPX	30268987
Stacking & Storage Cover, x1, STX SPX	30268988
Density Kit, STX	30269020
Anti-Theft Device, MB AX EX STX SPX	80850043
Carrying Case, Scout	30269021

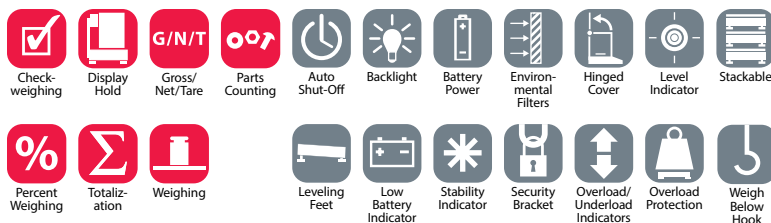

Navigator® Series

Rugged, Multi-Purpose Balances for a Wide Range of General Weighing Applications

- Designed for a range of essential weighing applications, the Navigator offers accuracy and repeatability at a competitive price point, making it a valuable tool in lab, industrial & education settings
- The Navigator series is designed to accurately stabilize in less than one second to provide fast and accurate weighing results, improving operator efficiency, productivity and throughput.
- An overload protection system that can withstand loads up to four times the rated capacity safeguards the balance. An integrated shipping lock protects the weighing cell during transportation/storage

Application Weighing, Parts Counting, Percent Weighing, Checkweighing

Display Backlit liquid crystal display (LCD)

Operation AC adapter (included) or 4 C batteries (not included)

Communication RS232, USB, or Ethernet (available as accessories)

Construction ABS housing, stainless steel pan, transportation lock, menu and calibration lock switch, slip-resistant and adjustable feet, leveling bubble.

Design Features Mechanical and software overload/underload protection, touchless sensor, user selectable print and communication options



NEW
Available Early/Mid 2019

Model	Capacity	Readability	Pan Size	Item No.
NV222	220g	0.01g	Ø145 mm / 5.7 in	30456410
NV422	420g			30456411
NV221	220g	0.1g	190 x 144 mm / 7.5 x 5.7 in	30456412
NV621	620g			30456413
NV1201	1200g			30456414
NV2201	2200g			30456415
NVT2201	2200g			30456416
NVT4201	4200g			30456417
NVT2200	2200g	1.0g	230 x 174 mm / 9.1 x 6.9 in	30456418
NVT6200	6200g			30456419
NVT12000	12000g			30456420
NVT22000	22000g			30456421

Accessories	Item No.
USB Interface	83032108
RS232 Interface	83032107
Ethernet Interface	83032109
Rechargeable Battery Kit	83032106
Carrying Case	30467963
Adapter with plugs (EU-US-UK-AU-KR)	30467987



CS Series

When Cost Matters But Dependable Results Are A Must

- The large weighing platform can accommodate larger samples and can also be removed for easy cleaning.
- Radio frequency protection allows the CS to deliver stable results even when used in areas in which radio waves may be emitted.
- The low profile CS is battery operated or can be powered by a standard AC adapter.



- Application** Weighing
- Display** Liquid crystal display (LCD)
- Operation** AC adapter (included) or 3 AA batteries(included)
- Construction** ABS Housing, Stainless Steel Pan
- Design Features** Mechanical and software overload / underload protection, auto shut-off

Model	Capacity	Readability	Pan Size	Item No.
CS200	200 g	0.1 g	5.75 in x 5.25 in / 145 mm x 133 mm	72212663
CS600	600g	0.1g		30422849
CS2000	2000 g	1 g		72212664
CS5000	5000 g			72212665

Model	Capacity	Readability	Pan Size	Item No.
CS200P	200 g	0.1 g	5.75 in x 5.25 in / 145 mm x 133 mm	80500633
CS2000P	2000 g	1 g		80500634
CS5000P	5000 g			80500635

"P" models include Postal Chart

Accessories	Item No.
Carrying Case, CS	80010624
Bowl, 1050ml, CS	80850075
Pan Cover, SST, CS	80850076

Accessories	Item No.
PWR,ACCES,AC-PRONG	46001776
PWR,W,IN,6W,12VDC,S21x55x9x100,S	46001724



CL Series

Reliable, Easy-to-Use Balance for Basic Weighing

- The low profile CL has a stackable design which allows the balance to be stored securely and orderly.
- The integrated load cell lock protects the weighing cell from damage during transportation and while in storage.
- The CL is battery operated and automatically shuts off after a certain period of non-use to preserve battery life.

Application Weighing
Display Liquid crystal display (LCD)
Operation 3 AA batteries (included) or AC adapter (accessory sold separately)
Construction ABS housing and pan
Design Features Mechanical and software overload/underload protection, auto shut-off



CL5000F



Model	Capacity	Readability	Pan Size	Item No.
CL201	200 g	0.1 g	Ø 4.75 in / Ø 120 mm	80010610
CL2000	2000 g	1 g		80010611
CL5000	5000 g			80010612
CL5000F				80010621

"F" model includes carrying case

Accessories	Item No.
PWR,ACCES,AC-PRONG	46001776
PWR,W,IN,6W,12VDC,S21x55x9x100,S	46001724
Pan Cover, SST, CL	80010623



HH Series

Convenient, Compact and Portable Weighing in a Functional Design

- HH is available in capacities ranging from 120 g to 320 g and is ideal for a variety of general, on-the-go weighing applications for many industries.
- A backlit display illuminates the screen for viewing in dim lighting conditions, and a power-saving automatic shut-off feature conserves battery life.
- Among HH's protective features are durable ABS housing and a snap-on cover for protection during storage and transportation.

Application Weighing
Display Liquid crystal display (LCD)
Operation 2 AAA batteries (included)
Construction ABS housing and pan, protective snap-on cover
Design Features Overload/underload indicators, external push-button calibration



Model	Capacity	Readability	Pan Size	Item No.
HH120	120 g	0.1 g	3.25 in x 3 in / 83 mm x 76 mm	71142842
HH120D	60 g / 120 g	0.2 g		71142841
HH320	320 g	0.1 g		71142844



Portable Balances

PS Series

High Performance Portable Weighing in the Palm Of Your Hand

- The one-piece combination pan and cover slides back when being used to weigh and forward when not in use to protect the buttons and display during storage and transportation.
- One of the smallest portable balances on the market, PS can easily fit into a standard shirt pocket.
- The “pop-out” design of the battery compartment provides simple and fast battery replacement.



- Application** Weighing
- Display** Liquid crystal display (LCD)
- Operation** 2 lithium batteries (included)
- Construction** ABS housing and protective sliding pan
- Design Features** Software overload/underload indicators, auto shut-off

Model	Capacity	Readability	Pan Size	Item No.
PS121	120 g	0.1 g	2.5 in x 2.5 in / 64 mm x 64 mm	80104060
PS251	250 g			80104061



YA Series

Portable Precision Weighing in a Compact Case

- A hinged cover, sturdy plastic housing and stainless steel weighing pan protect the small balance from damage.
- With an extremely fast stabilization time, your results will appear quickly on the blue backlit LCD display.
- Powered by two ‘AAA’ batteries, a power-saving auto shut-off feature helps to conserve battery life.



- Application** Weighing
- Display** Backlit liquid crystal display (LCD)
- Operation** 2 AAA batteries (included)
- Construction** ABS housing, stainless steel pan, protective cover
- Design Features** Mechanical and software overload indicator, auto shut-off

Model	Capacity	Readability	Pan Size	Item No.
YA102	100 g	0.01 g	2.8 in x 2 in / 70 mm x 50 mm	80251910
YA302	300 g	0.05 g		80251911
YA501	500 g	0.1 g		80251912



MB120

Moisture Analysis Made Simple and Powerful



- MB120's Temperature Guide analyzes a sample and determines the optimal drying temperature. Store up to 100 drying methods for easy recall and up to 1000 total results for statistical analysis.
- Precisely controlled halogen heating dries samples uniformly, producing repeatable results of 0.01% readability. Four drying profiles and predefined and user definable shut-off criteria help to perform customized sample tests.
- The MB120 features a removable pan handler and sample chamber for easy cleaning. Operating the MB120 is intuitive – simply follow the guided instructions on the touchscreen display.

- Application** Percent Moisture Determination, Percent Moisture Regain Determination, Percent Solid Determination, Weighing
- Display** 4.3" TFT color touchscreen display
- Operation** Power cord (included)
- Communication** RS232, USB Host and USB Device (included)
- Construction** Metal base, ABS top housing, halogen heat source, stainless steel pan support, stainless steel pan handler, in-use cover
- Design Features** Seven shut-off criteria (manual, timed, autofree %/s, autofree mg/s, A30, A60 and A90), four drying profiles (standard, fast, ramp and step), storage for up to 100 methods and 1000 test results for all methods, temperature guide, 40°C to 230°C heating temperature range (1°C increments), 13 operational languages

Model	Capacity	Readability	Moisture Readability	Pan Size	Item No.
MB120	120 g	1 mg	0.01 %	90 mm	30241165

Accessories	Item No.
Pan Holder, MB90 MB120	30246947
In-Use-Cover, Accessory, MB90 MB120	30284478
Scoop, Accessory, MB90 MB120	30284477
Temperature Calibration Kit	11113857
Anti-Theft Device	80850043
Pan, Aluminum, Set(80), MB Series	80850086

Accessories	Item No.
Filter, Glass Fiber, Set(200)	80850087
Cage, Sample, MB Series	80252477
Pan, Reusable, Set(3), 7 mm, MB Series	80252478
Pan, Reusable, Set(3), 14 mm, MB Series	80252479
Printer, Impact, SF40A	30064203
Cable, ST103-AV DV EX MB PA TxxP	80252581
Printer, Thermal, STP-103, US	80251992
Software, Winwedge	80850080



MB90

Combining Speed and Precision in One Moisture Analyzer —Test More Samples in Less Time



- The MB90's precisely controlled halogen heating dries samples quickly, and ensures uniform heating to yield fast, precise and repeatable results of 0.01% readability.
- Designed with effortless maintenance in mind, the MB90 features a removable pan handler and heating chamber components that make cleaning quick and easy - no tools needed.
- Icon-based menu navigation on the easy-to-read touchscreen display makes operating the MB90 intuitive. Perform routine sample testing in three easy steps – no training required.

- Application** Percent Moisture Determination, Percent Solid Determination, Weighing
- Display** 4.3" TFT color touchscreen display
- Operation** Power cord (included)
- Communication** RS232 with GLP/GMP data output, USB Host and USB Device (included)
- Construction** Metal base, ABS top housing, halogen heat source, stainless steel pan support, stainless steel pan handler, in-use cover
- Design Features** Three shut-off criteria (manual, timed or auto), two drying profiles (standard and fast), storage for up to two methods, 40°C to 200°C heating temperature range (1°C increments), 13 operational languages

Model	Capacity	Readability	Moisture Readability	Pan Size	Item No.
MB90	90 g	1 mg	0.01 %	90 mm	30241164

Accessories	Item No.
Pan Holder, MB90 MB120	30246947
In-Use-Cover, Accessory, MB90 MB120	30284478
Scoop, Accessory, MB90 MB120	30284477
Temperature Calibration Kit	11113857
Anti-Theft Device	80850043
Pan, Aluminum, Set(80), MB Series	80850086

Accessories	Item No.
Filter, Glass Fiber, Set(200)	80850087
Cage, Sample, MB Series	80252477
Pan, Reusable, Set(3), 7 mm, MB Series	80252478
Pan, Reusable, Set(3), 14 mm, MB Series	80252479
Printer, Impact, SF40A	30064203
Cable, ST103-AV DV EX MB PA TxxP	80252581
Printer, Thermal, STP-103, US	80251992
Software, Winwedge	80850080



MB27

The Affordable High Capacity Moisture Analyzer

- The MB27 provides accurate results at 0.01% 0.001 g. With a large capacity of 90 g, it is ideal for food, agriculture, chemical, pharmaceutical and other applications that require measurements up to 0.01% 0.001 g.
- Set up and operation is extremely easy. Just press and hold the temperature or time buttons to set drying parameters. The MB27 is ideal for routine tasks performed by operators of all skill levels.
- The compact footprint (17x14x28 cm) of the OHAUS MB27 is designed to take up less space. The easy-to-clean heating chamber is ideal for frequent use and inexpensive maintenance.



- Application** Percent Moisture Determination, Percent Solid Determination, Weighing
- Display** Backlit liquid crystal display (LCD)
- Operation** Power cord (included)
- Communication** RS232 (included)
- Construction** Halogen heat source, ABS housing, metal pan support, metal pan handler, in-use cover
- Design Features** 3 shut off criteria (manual, timed or auto), 1 standard heating profile, 50° to 160° C heating range (5° C increments)

Model	Capacity	Readability	Moisture Readability	Pan Size	Item No.
MB27	90 g	1 mg	0.01 %	90 mm	30251683

Accessories	Item No.
Temp. Calibration Kit, MB Series	11113857
Holder, Pan, MB23 MB27	11113873
Printer, Impact, SF40A, AM	30064203
Printer, Thermal, STP-103, US	80251992
In-Use-Cover, MB23 MB27	80252475
Pan Holder MB23 MB27	80252476
Cage, Sample, MB Series	80252477
Pan, Reusable, Set(3), 7 mm, MB Series	80252478

Accessories	Item No.
Pan, Reusable, Set(3), 14 mm, MB Series	80252479
Cable, ST103-AV DV EX MB PA TxxP	80252581
Cable, RS232, IBM 9P, AV DV MB Ranger	80500525
Cable, SF42-AV DV MB Ranger	80500571
Anti-Theft Device, MB AX EX	80850043
Software, Winwedge	80850080
Pan, Aluminum, Set(80), MB Series	80850086
Filter, Glass Fiber, Set(200)	80850087



Moisture Analyzers

MB23

Redefining Value in Moisture Analysis

- The MB23 utilizes a metallic sheathed, no glass infrared heating element for drying of samples.
- With a bright backlit LCD and easy one-button setup and menu navigation, MB23 is extremely user-friendly.
- MB23 is very easy-to-clean to ensure the integrity of your samples, and its compact design allows it to fit seamlessly into most workspaces.



- Application** Percent Moisture Determination, Percent Solid Determination, Weighing
- Display** Backlit liquid crystal display (LCD)
- Operation** Power cord (included)
- Communication** RS232 (included)
- Construction** Infrared heat source, ABS housing, metal pan support, metal pan handler, in-use cover
- Design Features** 3 shut off criteria (manual, timed or auto), 1 standard heating profile, 50° to 160° C heating range (5° C increments)

Model	Capacity	Readability	Moisture Readability	Pan Size	Item No.
MB23	110 g	10 mg	0.1 %	Ø 3.5 in / Ø 90 mm	83999801

Accessories	Item No.
Temp. Calibration Kit, MB Series	11113857
Holder, Pan, MB23 MB27	11113873
Printer, Impact, SF40A, AM	30064203
Printer, Thermal, STP-103, US	80251992
In-Use-Cover, MB23 MB27	80252475
Pan Holder MB23 MB27	80252476
Cage, Sample, MB Series	80252477
Pan, Reusable, Set(3), 7 mm, MB Series	80252478

Accessories	Item No.
Pan, Reusable, Set(3), 14 mm, MB Series	80252479
Cable, ST103-AV DV EX MB PA TxxP	80252581
Cable, RS232, IBM 9P, AV DV MB Ranger	80500525
Cable, SF42-AV DV MB Ranger	80500571
Anti-Theft Device, MB AX EX	80850043
Software, Winwedge	80850080
Pan, Aluminum, Set(80), MB Series	80850086
Filter, Glass Fiber, Set(200)	80850087



D500M

Economical Mechanical Bench Scale for Basic Industrial Applications

- Heavy-duty mechanical epoxy-painted steel construction makes D500M highly durable for industrial applications.
- Phenolic wheels allow for mobility and a beam lock is integrated to protect the indicator when the scale is in motion.
- Counterpoise weights allow for a maximum capacity of 1,000 lbs.

Display Easy-to-read, dual-side flat beam with a shadow-proof poise

Construction Epoxy painted steel, phenolic wheels



Model	Capacity	Readability	Certified Readability	Platform Size	Item No.
D500M	1000 lb	0.5 lb	0.5 lb	28.13 in x 19.25 in / 714 mm x 489 mm	80252735



Heavy Duty Solution

The Industry Standard for Precision and High Capacity Mechanical Weighing

- Oversized stainless steel platform to accommodate large samples or containers.
- A lockable Tare feature allows the operator to tare the balance once for multiple weighing procedures for containers up to 2270 g.
- Covers protect the self-aligning bearings which require little to no maintenance.

Display Front and rear indicator plate

Construction Metal base and beam, stainless steel pan



Model	Capacity	Readability	Pan Size	Item No.
1119-D0	20 kg	1 g	Ø 11 in / Ø 279 mm	80000000

Accessories	Item No.
Weight Set, Metric, 1119-D0	80780008



Field Test

Accurate Weighing Even Under Adverse Conditions

- The Field Test scale is available to provide weighing results rain or shine. Without the restrictions of connecting the scale to an outlet, weighing can be conducted in any setting.
- The large stable pan will hold oversized samples without tipping, and the weighted base keeps the entire scale extremely steady.
- The portable Field Test scale can be easily moved from location to location around your work site with the integrated carrying handle.



- Display** Sliding poise and graduated beam
- Construction** Metal base and beam, oversized stainless steel pan
- Design Features** Magnetic damping, positive load stops

Model	Capacity	Readability	Pan Size	Item No.
2400-12	36 lb	0.01 lb	Ø 11 in / Ø 279 mm	80000038
2400-11	16 kg	5 g	Ø 11 in / Ø 279 mm	80000008



Weighing

Triple Beam Pro®

Best-in-Class Mechanical Balance

- The unique, easy-grip carrying handle is ergonomically designed to allow for effortless movement around the classroom.
- A convenient compartment provides a place to store the included weight set when not in use, preventing the weights from becoming lost.
- Prevent theft and accidental dropping by securing the balance to a desk or bench top with the security loop or Kensington-type lock (sold separately).



- Display** Easy-to-read deep-notched, tiered beams and dial plates
- Construction** Metal base and beam, stainless steel pan
- Design Features** Two notched and tiered beams, positive poise positioning, spring loaded zero adjust compensator, self-aligning beam design, magnetic damping to minimize oscillation and speed weighing, security loop, included weight set and storage compartment. Includes rod & clamp assembly for below balance weighing.

Model	Capacity	Readability	Pan Size	Item No.
TP2611 with Rod and Clamp	2610 g	0.1 g	5.8 in x 5.8 in / 147 mm x 147 mm	80621692

Accessories	Item No.
Kit, Rod and Clamp	80780011
Dust Cover, Triple Beam	80780017
Weight Set, 2 x 1 kg, 1 x 500 g	80780108
Anti-Theft Device, SP PA AV NV	80850000
Anti-Theft Device, MB AX EX	80850043



Weighing

Triple Beam 700 Series

The Standard by Which All Other Mechanical Balances Are Measured

- Superior magnetic damping provides stable results three times faster than any other three-beam balance on the market.
- Five weighing pans of different sizes and designs can accommodate materials for a variety of weighing applications.
- A counterbalancing knob provides quick zeroing of the balance while a self-aligning beam helps ensure accurate results.



Display Easy to-read deep-notched, tiered beams and dial plates

Design Features Metal base and beam, stainless steel pan

Construction Easy-to-read notched and tiered beams, self-aligning beam design, magnetic damping to minimize oscillation and speed weighing, zero adjust compensator

Model	Tare Beam	Capacity	Readability	Pan Size	Pan Height	Pan Type	Item No.
720-00		610 g	0.1 g	12 in x 6 in / 30.5 mm x 152 mm	2.75 in/70 mm	Polypropylene Scoop	80000032
720-S0				12 in x 7.4 in / 305 mm x 188 mm	1.7 in/43 mm	Stainless Steel Scoop	80000033
710-00				Ø 6 in / Ø 152 mm	—	Removable Pan	80000011
750-S0						Fixed Pan	80000012
760-00	•					80000013	
710-T0	•					Removable Pan	80000031
730-00				Ø 9 in / Ø 229 mm	6 in/152 mm	Animal Container	80000034

Accessories	Item No.
Subject Box	80000053
Scoop and Counter Weight	80780001
Scoop, PP, 0.8 l	80780006
Kit, Rod and Clamp	80780011
Scoop and Counter Weight, Poly	80780014
Scoop and Counter Weight, SST	80780015

Accessories	Item No.
Scoop and Counter Weight, 1.75 l	80780016
Dust Cover, Triple Beam	80780017
Weight Set, 2 x 1 kg, 1 x 500 g	80780108
Anti-Theft Device, SP PA AV NV	80850000
Clamp, Gas Cylinder	80850312



Weighing

Triple Beam Junior

All the Benefits of a Triple Beam, Just for Younger Students

- The notched and tiered beams provide for easy reading of measurement results.
- Prevent theft and accidental dropping by securing the balance to a desk or bench top with the security loop (sold separately).
- The zero adjust compensator ensures the balance is at zero and weighing results will be accurate.



Display Easy to-read deep-notched, tiered beams and dial plates

Construction Metal base and beam, stainless steel pan

Design Features Notched and tiered beams, magnetic damping, zero adjust compensator

Model	Capacity	Readability	Pan Size	Item No.
TJ611	610 g	0.1 g	Ø 5.9 in / Ø 150 mm	80252052

Accessories	Item No.
Dust Cover, Triple Beam	80780017
Anti-Theft Device, SP PA AV NV	80850000



Weighing

Triple Beam Dial-O-Gram® 1600 Series

The Standard by Which All Others Are Measured

- Superior magnetic damping provides three times faster stability reading than any other three-beam balance on the market.
- Vernier dial convenience.
- Counterbalancing knob for quick zeroing, self-aligning beam design.



Display Easy to-read deep-notched, tiered beams and dial plates

Construction Metal base and beam, stainless steel pan

Design Features Counterbalancing knob for quick zeroing, positive poise positioning for repeatable results, self-aligning beam design, magnetic damping to minimize oscillation and speed weighing.

Model	Tare Beam	Capacity	Readability	Pan Size	Pan Type	Item No.
1650-00	•	610 g	0.1 g	Ø 6 in / Ø 152 mm	Fixed Plate	80000006
1610-00	•				Removable Pan	80000036
1650-W0	•	2610 g			Fixed Plate and attachment weights	80000037

Accessories	Item No.
Scoop, Flat Bottomed, SST, 0.6 l	80250400
Scoop and Counter Weight	80780001
Scoop, PP, 0.8 l	80780006
Kit, Rod and Clamp	80780011
Scoop and Counter Weight, Poly	80780014
Scoop and Counter Weight, SST	80780015

Accessories	Item No.
Scoop and Counter Weight, 1.75 l	80780016
Dust Cover, Triple Beam	80780017
Weight Set, 2 x 1 kg, 1 x 500 g	80780108
Anti-Theft Device, SP PA AV NV	80850000
Clamp, Gas Cylinder	80850312



Weighing

Dial-O-Gram® and Cent-O-Gram® 300 Series

Extremely Precise Mechanical Balance with High Readability

- With aluminum pressure castings for the base and beam assembly, agate bearings, steel knife-edges, and stainless steel pan, the Dial-O-Gram is built to the highest standard of quality.
- The three-point base, special floating bearing principle and beam design eliminates the need for level adjustments.
- The self-aligning beam ensures accurate results are garnered effortlessly.

Display Easy to-read deep-notched, tiered beams and dial plates

Construction Metal base and beam, stainless steel pan

Design Features Self-aligning beam design, magnetic damping to minimize oscillation and speed weighing, zero adjust compensator



Model	Capacity	Readability	Beams	Pan Size	Pan Height	Pan Type	Item No.
310-00	310 g	0.01 g	2 Beams with Dial	Ø 3.5 in / Ø 89 mm	0.5 in / 13 mm	Removable Pan	8000009
311-00	311 g		4 Beams				8000010

Accessories	Item No.
Dust Cover, Dial-O-Gram Cent-O-Gram	80780005
Anti-Theft Device, SP PA AV NV	80850000



Weighing

Harvard Junior

Two Pan Balance Designed to Teach Comparative Weighing

- The easy-grip carrying handle will help students and teacher alike securely move the balances around the classroom.
- The balances can be stacked to minimize the amount of storage space needed, and the lock feature protects the balance from damage when in storage.
- An eight piece weight set and bowls that fit on the weighing pans are included with every Harvard Junior.

Display Steel pointer

Construction ABS base, pans and bowls, metal beam

Design Features Manual damping device, spring-loaded zero adjust compensator
Includes teacher-developed activity guide



Model	Capacity	Readability	Pan Size	Item No.
HJ2001	2000 g	0.5 g	Ø 6 in / Ø 150 mm	80252050



Weighing

Harvard Trip®

Two Pan Balance Designed for Comparative Weighing

- The built-in sliding masses make weighing very simple and quick.
- Magnetic damping minimizes oscillation and helps speed up weighing.
- A counterbalancing knob provides quick zeroing of the balance while floating agate bearings help ensure accurate results.

Display Deep notched and tiered beams

Construction All-metal base and beam, stainless steel pan

Design Features Weight set (2000 g model, accessory sold separately), built-in sliding masses, magnetic damping, self-aligning beam design and floating agate bearings, counterbalancing knob for quick zeroing, hardened steel edges



Model	Capacity	Readability	Beams	Pan Size	Item No.
1450-SD	2000 g	0.1 g	Singe Beam	Ø 6.2 in / Ø 152 mm	80000003
1550-SD			2 Beams		80000004
1560-SD			2 Beams and Tare Beam		80000005

Accessories	Item No.
Scoop, PP, 0.8 l	80780006
Kit, Rod and Clamp	80780011
Scoop and Counter Weight, Poly	80780014
Scoop and Counter Weight, SST	80780015

Accessories	Item No.
Scoop and Counter Weight, 1.75 l	80780016
Anti-Theft Device, SP PA AV NV	80850000
Weight Set, 1 kg-1 g, ASTM 6, CYL	80850115
Dust Cover,Storage,Harvard	80850262



School Balance

The Young Scientist's First Balance

- Large, washable pans provide optimal space for samples to be weighed.
- 18 piece, color coded stackable plastic mass set included.
- Front and rear pointers allow students to view results from both sides of the balance.

Display Plastic pointer

Construction ABS base, beam, and pans

Design Features Zero adjust compensator



Model	Capacity	Readability	Pan Size	Item No.
SB1200	2000 g	0.5 g	5.5 in x 5.5 in / 140 mm x 140 mm	80000029



Primer® Balance

The Scale for Budding Scientists

- An activity guide with 16 exercises is included with every Primer balance.
- The easy-to-slide zero adjustment weight makes ensuring the balance is ready for weighing very simple.
- Front and rear pointers allow students to view results from both sides of the balance.



Display Plastic pointer

Construction ABS base, beam, and pans

Design Features Large, washable weighing pans, dual pointers, 18 piece stackable plastic mass set

Model	Capacity	Readability	Pan Size	Item No.
80410-00	2000 g	1 g	4 in x 4 in / 102 mm x 102 mm	80000024



Weighing

Spring Scales

Producing Reproducible Results at Unbeatable Prices

- Pull type spring scales feature an internal spring mechanism and offer a versatile and inexpensive way to display measurements in grams, ounces, pounds and Newtons.
- Dial type spring scales offer a versatile and inexpensive weight determination in classrooms, laboratories, field studies and much more.
- Demonstration spring scales offer a large faceplate for easy viewing and are ideal for all basic weighing applications.

Display Dial plates

Construction ABS housing with metal face plate, pointer, spring and hook

Design Features Large bright colored dial face, easy-to-read black graduations on a frosted aluminum background

Pull Type Spring Scales

Model	Capacity	Readability	Item No.
8001-MA	9 oz / 250 g	0.25 oz / 10 g	80000039
8002-MA	18 oz / 500 g	0.5 oz / 20 g	80000041
8004-MA	72 oz / 2000 g	2 oz / 50 g	80000044
8001-MN	250 g / 2.5 N	10 g / 0.1 N	80000014
8002-MN	500 g / 5 N	20 g / 0.2 N	80000015
8003-MN	1000 g / 10 N	25 g / 0.25 N	80000016
8004-MN	2000 g / 20 N	50 g / 0.5 N	80000017
8008-MN	5000 g / 50 N	100 g / 1 N	80000018
8261-MO	100 g	1 g	80000025
8262-MO	200 g	2 g	80000026
8263-MO	500 g	5 g	80000027
8264-MO	1000 g	10 g	80000028
8265-MO	2000 g	20 g	80000052
8001-PN	0.56 lb / 2.5 N	0.02 lb / 0.1 N	80000040
8002-PN	1.12 lb / 5 N	0.04 lb / 0.2 N	80000042
8003-PN	2.25 lb / 10 N	0.05 lb / 0.25 N	80000043
8004-PN	4.5 lb / 20 N	0.125 lb / 0.5 N	80000045
8008-PN	11.25 lb / 50 N	0.25 lb / 1 N	80000046



Dial Type Spring Scales

Model	Capacity	Readability	Item No.
8011-MA	9 oz / 250 g	0.125 oz / 2 g	80000047
8012-MA	18 oz / 500 g	0.25 oz / 5 g	80000048
8014-MA	2000 g / 72 oz	20 g / 0.5 oz	80000049
8011-MN	250 g / 2.5 N	2 g / 0.02 N	80000019
8012-MN	500 g / 5 N	5 g / 0.05 N	80000020
8014-MN	2000 g / 20 N	20 g / 0.2 N	80000022
8013-MN	1000 g / 10 N	10 g / 0.1 N	80000021
8016-00	20 N	1 / 2 N	80000023
8015-00	22 hg	1 / 2 hg	80000050
8018-50	50 N	2 N	80000051



Weighing

OHAUS Reloading Scales

The Original OHAUS Reloading Scales are Back

- Used by hunters, competitive sport shooters and archers since the 1960s, these scales are the standard for weighing charges to reload shells, checking ammunition and arrowheads, and designing custom loads.
- Equipped with cast metal beams designed with wide-spaced deep notches to prevent accidental poise movement. Self-aligning agate bearings with steel beam pivots guarantee sensitivity to 0.1 grain.
- 5-0-2 model with capacity to 505 grains is ideal for basic reloading, while the 5-0-5 offers capacity to 511 grains for more precise weighing. 10-10 offers 511 grains plus a 500 grain counterweight for weighing heavier items.



While Supplies Last



- Application** Weighing
- Display** Notched cast metal beams with large markings for easy reading using poises.
- Operation** Balance beams with magnetic dampening system to speed reloading.
- Communication** Easy access communication port with RS232 interface
- Construction** Cast metal housing and beams, stainless steel fine poises, hardened steel beam pivots, agate bearings, hanging metal pan support, gold-colored scoops with handle and spout
- Design Features** Scales include single leveling foot, ounce-to-grain conversion label for quick reference and large zero indicator. 10-10 model includes micrometer fine poise with nylon locking screw, 500 grain tare attachment weight and storage cover, and Approach-to-Weight feature.

Model	Capacity	Readability	Item No.	Item No.
5-0-2	505 grains	0.1 grains	2" dia. Scoop	30332165
5-0-5	511 grains			30393272
10-10	510 grains / 1,010 grains w/attachment weight			30332167



Weighing

Industrial Weighing



OHAUS offers a full line of products designed for industrial applications, including sophisticated, newly released software for our most powerful products. From shipping scales up to 10,000 lb floor scales, OHAUS has a product for use in every area of your facility.



Industrial Product Selector Guide

	Compact Bench Scales										Retail	Counting Scales			Modular Bench & Floor Scales					
	Ranger 7000	Ranger 4000	Ranger 3000	FD	Valor 7000	Valor 4000	Valor 3000	Valor 2000	Valor 1000	Catapult 1000	Aviator 7000	Ranger 7000	Ranger Count 4000	Ranger Count 3000	VX/VN Floor	Drum Scale	Defender 5000 - NEW	Defender 3000	CKW	ES / SD
Weighing Capacity Range (lb)	6 to 150	6 to 60	3 to 60	6 to 30	3 to 60	3 to 30	0.4 to 13.2	3 to 60	6 to 66	20 to 165	30 or 60	6 to 150	6 to 60	3 to 60	2,500 to 10,000	500 to 2,500	5 to 1,000	30 to 660	6 to 60	13 to 440
lb, oz, lb:oz	All	All	All	All	All	All	All	All	lb, oz	lb	lb	All	All	All	All	All	All	All	All	ES -all SD lb
kg or g	•	•	•	•	•	•	•	•	•	kg		•	•	•	•	•	•	•	•	ES -all SD - kg
Parts Counting	•	•	•									•	•	•	•	•	•	•	•	•
Checkweighing	•	•	•	•	•	•		•*	•			•	•	•		•	•		•	
Percent Weighing	•	•	•	•	•	•	•					•	•				•		•	
Display Hold / Dynamic Weighing	•	•	•									•	•			•	•		•	
Totalization / Accumulation		•	•		•	•			•		•		•	•		•	•		•	SD only
Retail Price/Lb											•									
Label Printing																				
NTEP Certified or Measurement Canada Approved	•	•	•	•*	•	•	NTEP*				NTEP	•	•	•	NTEP**		•	•	•	
Graphical Display	•											•					•			
LCD										•										•
Backlit LCD			•	•	•		•		•		•			•	•			•	•	
LED		•				•		•				•								
Numeric Keypad	•A										•	•A	•	•			•A		•A	
Metal	•	•										•	•		• Base	•*	•* Base			
ABS			•		•	•*		•*	•	•	•			•	•*	•*	•*		•*	
Stainless Steel				•		•*	•	•*							•*	•*	•*	•	•*	
Washdown IP/ NEMA Rating						•8	65 / 4X *	•8									67/ 4X **	65 / 4X *	66/ 4X	
NSF Listed/Certified				•	•	•	•	•	•										Base only	
RS232	•	•	•		•							•	•	•	•	•	•	•	•	
2nd RS232	○	○	○		○							○	○	○			○		○	
RS485/422																	○ 485		○	
USB	•	○	○		○							•	○	○		○	○			
Ethernet	○	○	○		○							○	○	○		○	○			
AC or DC Relays / Digital I/O	○											○					○		○	
Wireless Connectivity																	WiFi/ Bluetooth			
GMP w/Time/Date	•											•					•		•	
Rechargeable Battery	○	•	•	•	•	•		•	•		○	○	•	•	•		○	•	○	
Disposable Batteries							•			•	•									•
Remote Scale Base Input	○											○							•	
Page No.	60	61	62	64	63	65	66	67	68	68	84	57	58	59	37-38	36	40	52	39	55-56

○ Optional A Alphanumeric I Indicator **by base chosen *on specific models

Defender 3000 Drum Scale

Convenient Portability with Floor Scale Capacity

- 5 models from 500 to 2,500 lb in two base sizes -- 30" x 30" and 36" x 36" -- each with stainless steel handles and polyurethane wheels for mobility.
- Durably constructed from epoxy-painted carbon steel with treaded deck, nickel-plated alloy steel loadcells and aluminum junction box.
- Includes T32MC indicator with the most common industrial weighing modes.



NEW
Available Early/Mid
2019

- Application** Parts Counting, Dynamic Weighing, Checkweighing, Weight Accumulation
- Display** White backlit LCD display
- Operation** 9–12 VDC, 0.5A with included AC wall adapter
- Communication** Standard RS232; Optional Ethernet or USB available with RS232 kits.
- Construction** Epoxy-painted carbon steel frame and treaded deck, top adjustable carbon steel feet, IP67 nickel-plated alloy steel shear beam loadcells, IP65 aluminum junction box, T32ME indicator with painted metal back and ABS faceplate, 19.8 ft indicator cord with stainless steel folding cord storage cleats.
- Design Features** Easy mobility with integrated stainless steel folding handles and durable polyurethane wheels, indicator cord storage using folding stainless steel cleats on side of base. Indicator includes wall mount bracket.

Model	Capacity	Readability	Platform Size	Item No.
DFD32M500ES	500 lb / 250 kg	0.1 lb / 0.05 kg	30 x 30 in / 762 x 762 mm	30469909
DFD32M1000ES	1,000 lb / 500 kg	0.2 lb / 0.1 kg		30469910
DFD32M2500ES	2,500 lb / 1,250 kg	0.5 lb / 0.2 kg		30469911
DFD32M1000ER	1,000 lb / 500 kg	0.2 lb / 0.1 kg	36 x 36 in / 914 x 914 mm	30469912
DFD32M2500ER	2,500 lb / 1,250 kg	0.5 lb / 0.2 kg		30469913

Accessories	Item No.
Interface Kit, RS232-USB	30304101
Interface Kit, RS232-Ethernet	30304102
Printer SF40A (includes RS232 cable)	30064203
Printer, Thermal, STP-103, US (requires 80500525)	80251992
RS232 Interface Cable to PC 9-pin	80500525

Accessories	Item No.
Column Kit, Painted, 39" high for Floor Scale	30047153
Column Kit, Stainless Steel, 39" high for Floor Scale	30047154
RS232 Interface Cable to PC 25-pin	80500524
Software, Winwedge	80850080



VX Series

Economical Floor Scale for Basic Industrial Applications



- VX is ruggedly constructed and includes an epoxy painted steel frame, a NEMA 4X/IP65 stainless steel indicator, NEMA 4X/IP67 sealed plastic junction box and IP67 sealed load cells.
- The included internal rechargeable battery keeps the scale running and allows for placement of the platform away from outlets while the backlit LCD projects large 1" digits.
- Weighing and counting modes produce results in five weighing units, and the included RS232 provides the ability to connect the scale to a printer or PC for data reporting purposes.

- Application** Weighing, Parts Counting
- Display** Backlit liquid crystal display (LCD)
- Operation** Power cord (included) or rechargeable battery (included)
- Communication** Easy access communication port with RS232 interface (included)
- Construction** NEMA 4X/IP65 stainless steel indicator with hinged front-cover, 5mm fixed top plate, wall bracket, epoxy painted steel platform and frame, NEMA 4/IP67 plastic junction box with side access, 4 IP67 NTEP alloy steel load cells
- Design Features** 125% overload protection

Model	Capacity	Readability	Certified Readability	Platform Size	Item No.
VX32XW5000X	5000 lb / 2200 kg	1 lb / 0.5 kg	—	5 ft x 5 ft / 1,524 mm x 1,524 mm	80253296
VX32XW10000L	10000 lb / 4500 kg	2 lb / 1 kg		4 ft x 4 ft / 1,219 mm x 1,219 mm	80253297
VX32XW10000X				5 ft x 5 ft / 1,524 mm x 1,524 mm	80253298

Approved Model	Capacity	Readability	Certified Readability	Platform Size	Item No.
VX32XW2500L	2500 lb / 1000 kg	0.5 lb / 0.2 kg	0.5 lb / 0.2 kg	4 ft x 4 ft / 1,219 mm x 1,219 mm	80253294
VX32XW5000L	5000 lb / 2200 kg	1 lb / 0.5 kg	1 lb / 0.5 kg	4 ft x 4 ft / 1,219 mm x 1,219 mm	80253295

Accessories	Item No.
Printer, Impact, SF40A, AM	30064203
Printer, Thermal, STP-103, US (requires 80500525)	80251992
Foot Kit, Set(4), VX	80252545
Foot Plate, Set(2), Painted, VX	80252548
Column Kit, Painted, Floor Scale	30047153
Column Kit, Stainless Steel, Floor Scale	30047154

Accessories	Item No.
Ramp, 48 in wide x 48 in long, 2.5 K/5 K, VX	80252766
Ramp, 60 in wide x 48 in long, 5 K, VX	80252767
Ramp, 48 in wide x 48 in long, 10 K, VX	80252795
Ramp, 60 in wide x 48 in long, 10 K, VX	80252796
Bolt Kit, Floor, VX	80252838
Cable, RS232, IBM 9P, AV DV MB Ranger	80500525
Cable, RS232, CKW TxxXW	80500552
Software, Winwedge	80850080
Interface Kit, RS232-USB	30304101
Interface Kit, RS232-Ethernet	30304102

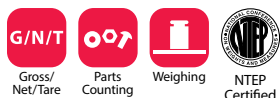

VN Series

Economical Painted Steel Floor Scales for Basic Industrial Applications



- The durable VN is constructed of an epoxy painted steel frame, an ABS T31P indicator, NEMA 4X/IP65 sealed stainless steel junction box and IP67 sealed load cells.
- With a rechargeable lead acid battery included with each VN, you can position the floor scale freely in the workspace without having to be forced to work near an outlet.
- Painted steel ramps are available to be added to any VN platform, which provide bottom support ribs that prevent the platform from bending under heavy loads.

- Application** Weighing, Parts Counting
- Display** Backlit liquid crystal display (LCD)
- Operation** AC adapter (included) or rechargeable battery (included)
- Communication** Easy access communication port with RS232 interface
- Construction** ABS plastic indicator, black painted steel treaded platform, NEMA 4X/IP65 stainless steel junction box with side access, IP67 NTEP alloy steel load cells, two carbon steel eye bolts, four self-swiveling ball-in-cup feet, black painted steel ramps and fixed location foot mounting plate kits (accessories sold separately)

Design Features 125% overload protection

Model	Capacity	Readability	Certified Readability	Platform Size	Item No.
VN31P5000L	5000 lb / 2500 kg	1 lb / 0.5 kg	1 lb / 0.5 kg	4 ft x 4 ft / 1,219 mm x 1,219 mm	80252563
VN31P5000X				5 ft x 5 ft / 1,524 mm x 1,524 mm	80252564

Accessories	Item No.
Column Kit, Painted, Floor Scale	30047153
Column Kit, SST, Floor Scale	30047154
Printer, Impact, SF40A, AM	30064203
Foot Plate, Set(2), Painted, VE VN	72198344
Printer, Thermal, STP-103, US (requires 80500525)	80251992

Accessories	Item No.
Ramp, 48 in wide x 26.4 in long, Painted, VN	80252565
Ramp, 60 in wide x 26.4 in long, Painted, VN	80252566
Cable, RS232, IBM 9P, AV DV MB Ranger	80500525
Software, Winwedge	80850080
Interface Kit, RS232-USB	30304101
Interface Kit, RS232-Ethernet	30304102

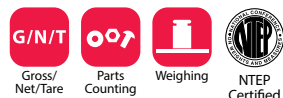

VN Series Floor Scale Platforms

Basic Level Floor Scale Bases

- Durable epoxy painted steel frame and platform
- NEMA4X/IP65 sealed stainless steel junction box
- IP67 sealed loadcells



Construction Black painted steel platform, raised embossed treads, fixed top plate 5mm thick, four IP67 NTEP alloy steel load cells, NEMA 4X/IP65 stainless steel junction box with side access, self swiveling stainless steel ball in cup leveling feet.

Design Features Ball-in-Cup Leveling Feet, Steel Eye Bolts for Easy Lifting and Positioning

Model	Capacity	Readability	Certified Readability	Platform Size	Item No.
VN5000L	5000 lb / 2500 kg	1 lb / 0.5 kg	1 lb / 0.5 kg	4 ft x 4 ft / 1,219 mm x 1,219 mm	80252561
VN5000X				5 ft x 5 ft / 1,524 mm x 1,524 mm	80252562



Bench Scales

CKW Checkweigher

Advanced Checkweighing Bench Scale for Food Processing Use

- The CKW features multiple Checkweighing options including Positive, Negative, Zero or Net and statistical capabilities to provide accurate results for advanced Checkweighing needs.
- The CKW's base is NSF Certified, supports HACCP-certified systems, and is safe for use in food processing applications.
- The base's open framework can be thoroughly cleaned to eliminate the risk of contamination caused by residue build up.

Application Weighing, Parts Counting, Percent Weighing, Checkweighing, Dynamic/Animal Weighing, Accumulation, Display Hold

Display Large backlit liquid crystal display (LCD) with secondary information line. 3 Checkweighing LEDs for indicating under, OK or over target weight ranges.

Operation AC power (included) or rechargeable battery (accessory sold separately)

Communication Easy access communication port including RS232 (included) and 2nd RS232 or RS422/RS485 (accessories sold separately). External tare input included. GLP/GMP data output with real-time clock.

Construction NEMA 4X/IP66 stainless steel indicator, 304 grade stainless steel platform with no visible threads, rounded corners, drain holes, extended skirt and open frame, IP67 stainless steel load cell, stainless steel column and wall bracket, level indicator.

Design Features 128 SKU memories, alphanumeric keypad, 150% overload capacity protection, five operating languages, NTEP Certified and Measurement Canada Approved, Alibi memory kit (accessory sold separately).



NEW



Model	Protection Rating	Capacity	Readability	Certified Readability	Platform Size	Item No.
CKW3R71XW	IP66 / NEMA4X	6 lb / 3 kg	0.001 lb / 0.5 g	0.002 lb / 1 g	10 in x 10 in / 254 mm x 254 mm	30448472
CKW6R71XW		15 lb / 6 kg	0.002 lb / 1 g	0.005 lb / 2 g		30448473
CKW15L71XW		30 lb / 15 kg	0.005 lb / 2 g	0.01 lb / 5 g	12in x 12in / 305mm x 305mm	30448474
CKW30L71XW		60 lb / 30 kg	0.01 lb / 5 g	0.02 lb / 10 g		30448475

Accessories	Item No.
Printer, Impact, SF40A, AM	30064203
Printer, Thermal, STP-103, US	80251992
PCBA Kit, Alibi Memory, R71 T71	80500503
Cable, RS232, CKW TxxXW	80500552
Relay Kit, AC, T51 T71	80500720
Wheel Kit, Defenders up to 600 lb / 300 kg capacity	30372146

Accessories	Item No.
Relay Kit, DC, T51 T71	80500727
Rechargeable Battery Kit, T51 T71	80500729
RS422/485 Kit, T51 T71	80500731
RS232 Kit, T51 T71	80500733
Wall Mount Kit, SST, T51XW T71XW	80500735
Software, Winwedge	80850080
Column Kit, Painted, Floor Stand	30047153
Column Kit, Stainless Steel, Floor Stand	30047154

* Base Only

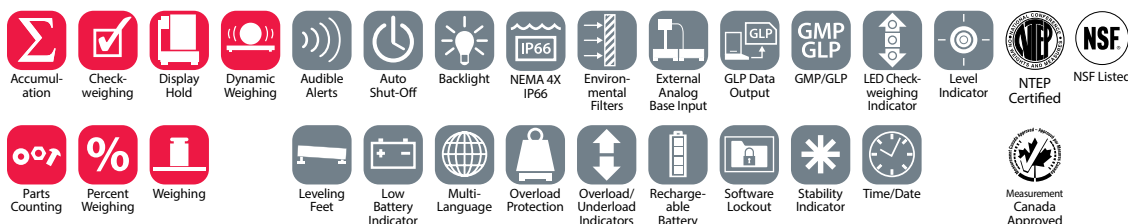

Defender® 5000 Washdown

High Performance Bench Scales for Advanced Applications

- Large transfective dot matrix display and SmarText 3.0 interface guides use with five soft keys makes an advanced operations very simple to use, reducing training time for operators.
- Supports up to 50,000 SKU items in memory and 1,000 user profiles with the included MicroSD card.
- Durably constructed from all stainless steel including IP67 protected stainless steel loadcells for added corrosion resistance.

Application Parts Counting with APW optimization, Checkweighing or Checkcounting, Percent Weighing, and Dynamic Weighing or Display Hold

Display Dot matrix LCD with white LED backlight, 256 x 80 pixels, with on-screen checkweighing display

Operation 100-240 VAC / 50/60 Hz Hardwired Universal Power Supply, Rechargeable Lithium battery (optional)

Communication Standard RS232, MicroSD Card included; Optional Ethernet, WiFi/Bluetooth, 2nd RS232/RS485/USB, Analog Output, or 2 In/4 Out Digital I/O.

Construction All stainless steel platform, base frame, indicator, column and loadcell.

Design Features Up to 25,000d/5,000e NTEP Class III certified and Measurement Canada Class III approved legal-for-trade, GMP/GLP output with time/date, EasyConnect connector allows fast set-up.



NEW
Available Early/Mid
2019



Model	Capacity	Readability	Certified Readability	Platform Size	Item No.
D52XW2WQS6	5 lb / 2.5 kg	0.0002 lb / 0.1g	0.001 lb / 0.5 g	10 x 10 in / 254 x 254 mm	30461673
D52XW5WQS6	10 lb / 5 kg	0.0005 lb / 0.2 g	0.002 lb / 1 g		30461674
D52XW12WQS6	25 lb / 12.5 kg	0.001 lb / 0.5 g	0.005 lb / 5 g		30461675
D52XW12WQR6				30461676	
D52XW25WQR6	50 lb / 25 kg	0.002 lb / 1 g	0.01 lb / 5 g	12 x 12 in / 305 x 305 mm	30461677
D52XW50WQR6	100 lb / 50 kg	0.005 lb / 2 g	0.02 lb / 10 g	18 x 18 in / 457 x 457 mm	30461678
D52XW25WQL7	50 lb / 25 kg	0.002 lb / 1 g	0.01 lb / 5 g		30461679
D52XW50WQL7	100 lb / 50 kg	0.005 lb / 2 g	0.02 lb / 10 g		30461680
D52XW125WQL7	250 lb / 125 kg	0.01 lb / 5 g	0.05 lb / 50 g	18 x 24 in / 457 x 610 mm	30461681
D52XW50WTX7	100 lb / 50 kg	0.005 lb / 2 g	0.02 lb / 10 g		30461682
D52XW125WTX7	250 lb / 125 kg	0.01 lb / 5 g	0.05 lb / 50 g		30461683
D52XW250WTX7	500 lb / 250 kg	0.02 lb / 10 g	0.1 lb / 50 g	24 x 24 in / 610 x 610 mm	30461684
D52XW50WQV8	100 lb / 50 kg	0.005 lb / 2 g	0.02 lb / 10 g		30461685
D52XW125WQV8	250 lb / 125 kg	0.01 lb / 5 g	0.05 lb / 50 g		30461686
D52XW250WQV8	500 lb / 250 kg	0.02 lb / 10 g	0.1 lb / 50 g		30461687
D52XW500WQV8*	1,000 lb / 500 kg	0.05 lb / 20 g	0.2 lb / 100 g		30461688

* Aluminum IP67 loadcell

Accessories	Item No.	Accessories	Item No.
2nd RS232/RS485/USB, TD523	30424404	In-use Cover set (10), TD52XW	30469949
Ethernet Kit, D522	30429666	LC Extension Cable, 9 meters, D521	30424409
Analog Output Kit, TD523	30424403	M16 Gland with Ferrite, to TD52	30379716
I/O with Relay (2 In/4 Out)	30097591	Printer SF40A (includes RS232 cable)	30064203
Light Tower, R-Y-G, IP65, 24VDC (requires 30097591)	30424021	Printer, Thermal, STP-103, US (requires 80500525)	80251992
WiFi/BT Dongle, OHAUS (Requires 30424406)	30412537	Cable, RS232, CKW TxxXW	80500552
USB Host for WiFi/BT Dongle, TD52	30424406	Printer Holder Kit, D52	30424025
Battery Kit, Li-ion, TD52	30424405	Software, Winwedge	80850080
In-use Cover Set, TD52XW	30424023	Wheel Kit, Defenders up to 600 lb / 300 kg capacity	30372146



Defender® 5000 Washdown Low Profile

Multifunctional Stainless Steel Washdown Bench Scales for Standard Industrial Applications

- Large transfective dot matrix display and SmarText 3.0 interface guides use with five soft keys makes an advanced operations very simple to use, reducing training time for operators.
- Supports up to 50,000 SKU items in memory and 1,000 user profiles with the included MicroSD card.
- Durably constructed from all stainless steel including IP67 protected stainless steel loadcells for added corrosion resistance.



NEW
Available Early/Mid
2019

Application Parts Counting with APW optimization, Checkweighing or Checkcounting, Percent Weighing, and Dynamic Weighing or Display Hold

Display Dot matrix LCD with white LED backlight, 256 x 80 pixels, with on-screen checkweighing display

Operation 100-240 VAC / 50/60 Hz Hardwired Universal Power Supply, Rechargeable Lithium battery (optional)

Communication Standard RS232, MicroSD Card included; Optional Ethernet, WiFi/Bluetooth, 2nd RS232/RS485/USB, Analog Output, or 2 In/4 Out Digital I/O.

Construction All stainless steel platform, base frame, indicator, indicator front mount and loadcell.

Design Features Up to 25,000d/5,000e NTEP Class III certified and Measurement Canada Class III approved legal-for-trade, GMP/GLP output with time/date, EasyConnect connector allows fast set-up.



Model	Capacity	Readability	Certified Readability	Platform Size	Item No.
D52XW2WQS5	5 lb / 2.5 kg	0.0002 lb / 0.1 g	0.001 lb / 0.5 g	10 x 10 in / 254 x 254 mm	30461661
D52XW5WQS5	10 lb / 5 kg	0.0005 lb / 0.2 g	0.002 lb / 1 g		30461662
D52XW12WQS5	25 lb / 12.5 kg	0.001 lb / 0.5 g	0.005 lb / 5 g		30461663
D52XW12WQR5				30461664	
D52XW25WQR5	50 lb / 25 kg	0.002 lb / 1 g	0.01 lb / 5 g	12 x 12 in / 305 x 305 mm	30461665
D52XW50WQR5	100 lb / 50 kg	0.005 lb / 2 g	0.02 lb / 10 g	18 x 18 in / 457 x 457 mm	30461464
D52XW25WQL5	50 lb / 25 kg	0.002 lb / 1 g	0.01 lb / 5 g		30461465
D52XW50WQL5	100 lb / 50 kg	0.005 lb / 2 g	0.02 lb / 10 g		30461466
D52XW125WQL5	250 lb / 125 kg	0.01 lb / 5 g	0.05 lb / 50 g	18 x 24 in / 457 x 610 mm	30461467
D52XW50WTX5	100 lb / 50 kg	0.005 lb / 2 g	0.02 lb / 10 g		30461668
D52XW125WTX5	250 lb / 125 kg	0.01 lb / 5 g	0.05 lb / 50 g		30461669
D52XW250WTX5	500 lb / 250 kg	0.02 lb / 10 g	0.1 lb / 50 g	24 x 24 in / 610 x 610 mm	30461670
D52XW50WQV5	100 lb / 50 kg	0.005 lb / 2 g	0.02 lb / 10 g		30461671
D52XW125WQV5	250 lb / 125 kg	0.01 lb / 5 g	0.05 lb / 50 g		30461672

Accessories	Item No.	Accessories	Item No.
2nd RS232/RS485/USB, TD523	30424404	In-use Cover set (10), TD52XW	30469949
Ethernet Kit, D522	30429666	LC Extension Cable, 9 meters, D521	30424409
Analog Output Kit, TD523	30424403	M16 Gland with Ferrite, to TD52	30379716
I/O with Relay (2 In/4 Out)	30097591	Wall Mount Kit, SST, TD52XW	30424026
Light Tower, R-Y-G, IP65, 24VDC (requires 30097591)	30424021	Printer SF40A (includes RS232 cable)	30064203
WiFi/BT Dongle, OHAUS (Requires 30424406)	30412537	Printer, Thermal, STP-103, US (requires 80500525)	80251992
USB Host for WiFi/BT Dongle, TD52	30424406	Cable, RS232, CKW TxxXW	80500552
Battery Kit, Li-ion, TD52	30424405	Printer Holder Kit, D52	30424025
In-use Cover Set, TD52XW	30424023	Software, Winwedge	80850080
		Wheel Kit, Defender up to 600 lb / 300 kg capacity	30372146



Defender® 5000

Multifunctional Bench Scales for Standard Industrial Applications

- Large transfective dot matrix display and SmarText 3.0 interface guides use with five soft keys makes an advanced operations very simple to use, reducing training time for operators.
- Supports up to 50,000 SKU items in memory and 1,000 user profiles with the included MicroSD card.
- Durably constructed with stainless steel platform, powder-coated steel bases and columns, aluminum loadcells and either stainless steel or ABS plastic indicators.

Application Parts Counting with APW optimization, Checkweighing or Checkcounting, Percent Weighing, and Dynamic Weighing or Display Hold

Display Dot matrix LCD with white LED backlight, 256 x 80 pixels, with on-screen checkweighing display

Operation 100-240 VAC / 50/60 Hz Universal Power Supply, Rechargeable Lithium battery (optional)

Communication Standard RS232, MicroSD Card included; Optional Ethernet, WiFi/Bluetooth, 2nd RS232/RS485/USB, Analog Output, or 2 In/4 Out Digital I/O.

Construction Stainless steel platform, powder-coated steel base frame and column, aluminum loadcell and stainless steel indicator.

Design Features Up to 25,000d/5,000e NTEP Class III certified and Measurement Canada Class III approved legal-for-trade, GMP/GLP output with time/date, EasyConnect connector allows fast set-up.



NEW
Available Early/Mid
2019



Model	Capacity	Readability	Certified Readability	Platform Size	Item No.
D52XW12RQR1	25 lb / 12.5 kg	0.001 lb / 0.5 g	0.005 lb / 2 g	12 x 12 in / 305 x 305 mm	30461689
D52XW25RQR1	50 lb / 25 kg	0.002 lb / 1 g	0.01 lb / 5 g		30461690
D52XW50RQR1	100 lb / 50 kg	0.005 lb / 2 g	0.02 lb / 10 g		30461691
D52XW12RTR1	25 lb / 12.5 kg	0.001 lb / 0.5 g	0.005 lb / 2 g	12 x 14 in / 305 x 355 mm	30461692
D52XW25RTR1	50 lb / 25 kg	0.002 lb / 1 g	0.01 lb / 5 g		30461693
D52XW50RTR1	100 lb / 50 kg	0.005 lb / 2 g	0.02 lb / 10 g	18 x 18 in / 457 x 457 mm	30461694
D52XW50RQL2					30461695
D52XW125RQL2	250 lb / 125 kg	0.01 lb / 5 g	0.05 lb / 20 g		30461696
D52XW50RTX2	100 lb / 50 kg	0.005 lb / 2 g	0.02 lb / 10 g	18 x 24 in / 457 x 610 mm	30461697
D52XW125RTX2	250 lb / 125 kg	0.01 lb / 5 g	0.05 lb / 20 g		30461698
D52XW250RTX2	500 lb / 250 kg	0.02 lb / 10 g	0.1 lb / 50 g		30461699
D52XW50RQV3	100 lb / 50 kg	0.005 lb / 2 g	0.02 lb / 10 g	24 x 24 in / 610 x 610 mm	30461700
D52XW125RQV3	250 lb / 125 kg	0.01 lb / 5 g	0.05 lb / 20 g		30461701
D52XW250RQV3	500 lb / 250 kg	0.02 lb / 10 g	0.1 lb / 50 g		30461702
D52XW500RQV3	1,000 lb / 500 kg	0.05 lb / 20 g	0.2 lb / 100 g	23.6 x 31.5 in / 600 x 800 mm	30461703
D52XW125RTV3	250 lb / 125 kg	0.01 lb / 5 g	0.05 lb / 20 g		30461704
D52XW250RTV3	500 lb / 250 kg	0.02 lb / 10 g	0.1 lb / 50 g		30461705
D52XW500RTV3	1,000 lb / 500 kg	0.05 lb / 20 g	0.2 lb / 100 g	30461706	

Accessories	Item No.	Accessories	Item No.
2nd RS232/RS485/USB, TD523	30424404	In-use Cover set (10), TD52XW	30469949
Ethernet Kit, D522	30429666	LC Extension Cable, 9 meters, D521	30424409
Analog Output Kit, TD523	30424403	M16 Gland with Ferrite, to TD52	30379716
I/O with Relay (2 In/4 Out)	30097591	Printer SF40A (includes RS232 cable)	30064203
Light Tower, R-Y-G, IP65, 24VDC (requires 30097591)	30424021	Printer, Thermal, STP-103, US (requires 80500525)	80251992
WiFi/BT Dongle, OHAUS (Requires 30424406)	30412537	Cable, RS232, CKW TxxXW	80500552
USB Host for WiFi/BT Dongle, TD52	30424406	Printer Holder Kit, D52	30424025
Battery Kit, Li-ion, TD52	30424405	Software, Winwedge	80850080
In-use Cover Set, TD52XW	30424023	Wheel Kit, Defender up to 600 lb / 300 kg capacity	30372146



Defender® 5000

Multifunctional Bench Scales for Standard Industrial Applications

- Large transfective dot matrix display and SmarText 3.0 interface guides use with five soft keys makes an advanced operations very simple to use, reducing training time for operators.
- Supports up to 50,000 SKU items in memory and 1,000 user profiles with the included MicroSD card.
- Durably constructed with stainless steel platform, powder-coated steel bases and columns, aluminum loadcells and ABS plastic indicators.

Application Parts Counting with APW optimization, Checkweighing or Checkcounting, Percent Weighing, and Dynamic Weighing or Display Hold

Display Dot matrix LCD with white LED backlight, 256 x 80 pixels, with on-screen checkweighing display

Operation 100-240 VAC / 50/60 Hz Universal Power Supply, Rechargeable Lithium battery (optional)

Communication Standard RS232, MicroSD Card included; Optional Ethernet, WiFi/Bluetooth, 2nd RS232/RS485/USB, Analog Output, or 2 In/4 Out Digital I/O.

Construction Stainless steel platform, powder-coated steel base frame and column, aluminum loadcell and ABS plastic indicator.

Design Features Up to 25,000d/5,000e NTEP Class III certified and Measurement Canada Class III approved legal-for-trade, GMP/GLP output with time/date, EasyConnect connector allows fast set-up.



NEW
Available Early/Mid
2019



Model	Capacity	Readability	Certified Readability	Platform Size	Item No.
D52P12RQR1	25 lb / 12.5 kg	0.001 lb / 0.5 g	0.005 lb / 2 g	12 x 12 in / 305 x 305 mm	30461630
D52P25RQR1	50 lb / 25 kg	0.002 lb / 1 g	0.01 lb / 5 g		30461631
D52P50RQR1	100 lb / 50 kg	0.005 lb / 2 g	0.02 lb / 10 g		30461632
D52P12RTR1	25 lb / 12.5 kg	0.001 lb / 0.5 g	0.005 lb / 2 g	12 x 14 in / 305 x 355 mm	30461633
D52P25RTR1	50 lb / 25 kg	0.002 lb / 1 g	0.01 lb / 5 g		30461634
D52P50RTR1	100 lb / 50 kg	0.005 lb / 2 g	0.02 lb / 10 g		30461635
D52P50RQL2	250 lb / 125 kg	0.01 lb / 5 g	0.05 lb / 20 g	18 x 18 in / 457 x 457 mm	30461636
D52P125RQL2					30461637
D52P50RTX2	100 lb / 50 kg	0.005 lb / 2 g	0.02 lb / 10 g	18 x 24 in / 457 x 610 mm	30461638
D52P125RTX2	250 lb / 125 kg	0.01 lb / 5 g	0.05 lb / 20 g		30461639
D52P250RTX2	500 lb / 250 kg	0.02 lb / 10 g	0.1 lb / 50 g	24 x 24 in / 610 x 610 mm	30461640
D52P50RQV3	100 lb / 50 kg	0.005 lb / 2 g	0.02 lb / 10 g		30461641
D52P125RQV3	250 lb / 125 kg	0.01 lb / 5 g	0.05 lb / 20 g		30461642
D52P250RQV3	500 lb / 250 kg	0.02 lb / 10 g	0.1 lb / 50 g		30461643
D52P500RQV3	1,000 lb / 500 kg	0.05 lb / 20 g	0.2 lb / 100 g	23.6 x 31.5 in / 600 x 800 mm	30461644
D52P125RTV3	250 lb / 125 kg	0.01 lb / 5 g	0.05 lb / 20 g		30461645
D52P250RTV3	500 lb / 250 kg	0.02 lb / 10 g	0.1 lb / 50 g		30461646
D52P500RTV3	1,000 lb / 500 kg	0.05 lb / 20 g	0.2 lb / 100 g		30461647

Accessories	Item No.	Accessories	Item No.
2nd RS232/RS485/USB, TD523	30424404	In-use Cover set (10), TD52P	30469948
Ethernet Kit, D522	30429666	LC Extension Cable, 9 meters, D521	30424409
Analog Output Kit, TD523	30424403	M16 Gland with Ferrite, to TD52	30379716
I/O with Relay (2 In/4 Out)	30097591	Printer SF40A (includes RS232 cable)	30064203
Light Tower, R-Y-G, IP65, 24VDC (requires 30097591)	30424021	Printer, Thermal, STP-103, US (requires 80500525)	80251992
WiFi/BT Dongle, OHAUS (Requires 30424406)	30412537	RS232 Interface Cable to PC 9-pin	80500525
USB Host for WiFi/BT Dongle, TD52	30424406	Printer Holder Kit, D52	30424025
Battery Kit, Li-ion, TD52	30424405	Software, Winwedge	80850080
In-use Cover Set, TD52P	30424022	Wheel Kit, Defender up to 600 lb / 300 kg capacity	30372146



Defender® 5000 Low Profile

Multifunctional Bench Scales for Standard Industrial Applications

- Large transfective dot matrix display and SmarText 3.0 interface guides use with five soft keys makes an advanced operations very simple to use, reducing training time for operators.
- Supports up to 50,000 SKU items in memory and 1,000 user profiles with the included MicroSD card.
- Durably constructed with stainless steel platform and indicator front mount, powder-coated steel bases, aluminum loadcells and stainless steel indicators.



NEW
Available Early/Mid
2019

Application Parts Counting with APW optimization, Checkweighing or Checkcounting, Percent Weighing, and Dynamic Weighing or Display Hold

Display Dot matrix LCD with white LED backlight, 256 x 80 pixels, with on-screen checkweighing display

Operation 100-240 VAC / 50/60 Hz Hardwired Universal Power Supply, Rechargeable Lithium battery (optional)

Communication Standard RS232, MicroSD Card included; Optional Ethernet, WiFi/Bluetooth, 2nd RS232/RS485/USB, Analog Output, or 2 In/4 Out Digital I/O.

Construction Stainless steel platform and indicator front mount, powder-coated steel base frame, aluminum loadcell and stainless steel indicator.

Design Features Up to 25,000d/5,000e NTEP Class III certified and Measurement Canada Class III approved legal-for-trade, GMP/GLP output with time/date, EasyConnect connector allows fast set-up.



Model	Capacity	Readability	Certified Readability	Platform Size	Item No.
D52XW12RQR5	25 lb / 12.5 kg	0.001 lb / 0.5 g	0.005 lb / 2 g	12 x 12 in / 305 x 305 mm	30467608
D52XW25RQR5	50 lb / 25 kg	0.002 lb / 1 g	0.01 lb / 5 g		30467609
D52XW50RQR5	100 lb / 50 kg	0.005 lb / 2 g	0.02 lb / 10 g		30467610
D52XW12RTR5	25 lb / 12.5 kg	0.001 lb / 0.5 g	0.005 lb / 2 g	12 x 14 in / 305 x 355 mm	30467611
D52XW25RTR5	50 lb / 25 kg	0.002 lb / 1 g	0.01 lb / 5 g		30467612
D52XW50RTR5	100 lb / 50 kg	0.005 lb / 2 g	0.02 lb / 10 g		30467613
D52XW50RQL5				30467614	
D52XW125RQL5	250 lb / 125 kg	0.01 lb / 5 g	0.05 lb / 20 g	18 x 18 in / 457 x 457 mm	30467615
D52XW50RTX5	100 lb / 50 kg	0.005 lb / 2 g	0.02 lb / 10 g		30467616
D52XW125RTX5	250 lb / 125 kg	0.01 lb / 5 g	0.05 lb / 20 g	18 x 24 in / 457 x 610 mm	30467617
D52XW250RTX5	500 lb / 250 kg	0.02 lb / 10 g	0.1 lb x 50 g		30467618
D52XW50RQV5	100 lb / 50 kg	0.005 lb / 2 g	0.02 lb / 10 g		30467619
D52XW125RQV5	250 lb / 125 kg	0.01 lb / 5 g	0.05 lb / 20 g	24 x 24 in / 610 x 610 mm	30467620
D52XW250RQV5	500 lb / 250 kg	0.02 lb / 10 g	0.1 lb / 50 g		30470990
D52XW125RTV5	250 lb / 125 kg	0.01 lb / 5 g	0.05 lb / 20 g	23.6 x 31.5 in / 600 x 800 mm	30467621

Accessories	Item No.
2nd RS232/RS485/USB, TD523	30424404
Ethernet Kit, D522	30429666
Analog Output Kit, TD523	30424403
I/O with Relay (2 In/4 Out)	30097591
Light Tower, R-Y-G, IP65, 24VDC (requires 30097591)	30424021
WiFi/BT Dongle, OHAUS (Requires 30424406)	30412537
USB Host for WiFi/BT Dongle, TD52	30424406
Battery Kit, Li-ion, TD52	30424405
In-use Cover Set, TD52XW	30424023

Accessories	Item No.
In-use Cover set (10), TD52XW	30469949
LC Extension Cable, 9 meters, D521	30424409
M16 Gland with Ferrite, to TD52	30379716
Wall Mount Kit, SST, TD52XW	30424026
Printer SF40A (includes RS232 cable)	30064203
Printer, Thermal, STP-103, US (requires 80500525)	80251992
Cable, RS232, CKW TxxXW	80500552
Printer Holder Kit, D52	30424025
Software, Winwedge	80850080
Wheel Kit, Defender up to 600 lb / 300 kg capacity	30372146



Defender® 5000 Low Profile

Multifunctional Bench Scales for Standard Industrial Applications

- Large transfective dot matrix display and SmarText 3.0 interface guides use with five soft keys makes an advanced operations very simple to use, reducing training time for operators.
- Supports up to 50,000 SKU items in memory and 1,000 user profiles with the included MicroSD card.
- Durably constructed with stainless steel platform and indicator front mount, powder-coated steel bases, aluminum loadcells and ABS plastic indicators.



NEW
Available Early/Mid
2019



- Application** Parts Counting with APW optimization, Checkweighing or Checkcounting, Percent Weighing, and Dynamic Weighing or Display Hold
- Display** Dot matrix LCD with white LED backlight, 256 x 80 pixels, with on-screen checkweighing display
- Operation** 100-240 VAC / 50/60 Hz Hardwired Universal Power Supply, Rechargeable Lithium battery (optional)
- Communication** Standard RS232, MicroSD Card included; Optional Ethernet, WiFi/Bluetooth, 2nd RS232/RS485/USB, Analog Output, or 2 In/4 Out Digital I/O.
- Construction** Stainless steel platform and indicator front mount, powder-coated steel base frame, aluminum loadcell and ABS plastic Indicator.
- Design Features** Up to 25,000d/5,000e NTEP Class III certified and Measurement Canada Class III approved legal-for-trade, GMP/GLP output with time/date, EasyConnect connector allows fast set-up.

Model	Capacity	Readability	Certified Readability	Platform Size	Item No.
D52P12RQR5	25 lb / 12.5 kg	0.001 lb / 0.5 g	0.005 lb / 2 g	12 x 12 in / 305 x 305 mm	30461648
D52P25RQR5	50 lb / 25 kg	0.002 lb / 1 g	0.01 lb / 5 g		30461649
D52P50RQR5	100 lb / 50 kg	0.005 lb / 2 g	0.02 lb / 10 g		30461650
D52P12RTR5	25 lb / 12.5 kg	0.001 lb / 0.5 g	0.005 lb / 2 g	12 x 14 in / 305 x 355 mm	30461651
D52P25RTR5	50 lb / 25 kg	0.002 lb / 1 g	0.01 lb / 5 g		30461652
D52P50RTR5	100 lb / 50 kg	0.005 lb / 2 g	0.02 lb / 10 g		30461653
D52P50RQL5	250 lb / 125 kg	0.01 lb / 5 g	0.05 lb / 20 g	18 x 18 in / 457 x 457 mm	30461654
D52P125RQL5					30461655
D52P50RTX5	100 lb / 50 kg	0.005 lb / 2 g	0.02 lb / 10 g	18 x 24 in / 457 x 610 mm	30461656
D52P125RTX5	250 lb / 125 kg	0.01 lb / 5 g	0.05 lb / 20 g		30461657
D52P250RTX5	500 lb / 250 kg	0.02 lb / 10 g	0.1 lb / 50 g		30461658
D52P50RQV5	100 lb / 50 kg	0.005 lb / 2 g	0.02 lb / 10 g	24 x 24 in / 610 x 610 mm	30461659
D52P125RQV5	250 lb / 125 kg	0.01 lb / 5 g	0.05 lb / 20 g		30461660
D52P250RQV5	500 lb / 250 kg	0.02 lb / 10 g	0.1 lb / 50 g		30467606
D52P125RTV5	250 lb / 125 kg	0.01 lb / 5 g	0.05 lb / 20 g	23.6 x 31.5 in / 600 x 800 mm	30467607

Accessories	Item No.
2nd RS232/RS485/USB, TD523	30424404
Ethernet Kit, D522	30429666
Analog Output Kit, TD523	30424403
I/O with Relay (2 In/4 Out)	30097591
Light Tower, R-Y-G, IP65, 24VDC (requires 30097591)	30424021
WiFi/BT Dongle, OHAUS (Requires 30424406)	30412537
USB Host for WiFi/BT Dongle, TD52	30424406
Battery Kit, Li-ion, TD52	30424405
In-use Cover Set, TD52P	30424022
In-use Cover set (10), TD52P	30469948

Accessories	Item No.
LC Extension Cable, 9 meters, D521	30424409
M16 Gland with Ferrite, to TD52	30379716
Wall Mount Kit, CS, TD52P	30424027
Printer SF40A (includes RS232 cable)	30064203
Printer, Thermal, STP-103, US (requires 80500525)	80251992
RS232 Interface Cable to PC 9-pin	80500525
Printer Holder Kit, D52	30424025
Software, Winwedge	80850080
Wheel Kit, Defender up to 600 lb / 300 kg capacity	30372146



Defender® 7000

High Performance Bench Scales for Advanced Applications

- Defender 7000 has advanced features such as accumulation mode, a 128-item library and optional alibi memory capability, as well as a 1:15,000 maximum displayed resolution.
- This advanced scale has dual-scale capabilities in which it can display the weights from two platforms and is powerful enough to drive up to 8 - 350 ohm load cells per platform.

Application Weighing, Parts Counting, Percent Weighing, Checkweighing, Dynamic/Animal Weighing, Accumulation, Display Hold

Display Backlit liquid crystal display (LCD) with secondary information line, 3 color Checkweighing LEDs

Operation Power cord (included) or rechargeable battery (accessory sold separately)

Communication Easy access communication port including RS232 (included) and 2nd RS232 or RS422/RS485 (accessories sold separately). GLP/GMP data output with real-time clock

Construction Bench scales with "W" bases are IP66 washdown protected with IP66 stainless steel indicator, IP67 stainless steel load cell, 304 stainless steel column, pan and form-and-weld base frame. Bench scales with "H" bases are IP66 washdown protected IP66 stainless steel indicator, IP67 aluminum load cell, 304 grade stainless steel pan with black polyurethane painted steel column and form-and-weld frame.

Design Features Alibi memory kit (accessory sold separately), 150% overload capacity protection, five operating languages, NTEP Certified and Measurement Canada Approved



For a Limited Time



Model	Protection Rating	Capacity	Readability	Certified Readability	Platform Size	Item No.
D71XW10WR3	IP66; NEMA 4X	20 lb / 10 kg	0.002 lb / 1 g	0.005 lb / 2 g	12 in x 12 in / 305 mm x 305 mm	80501537
D71XW15HR1	Not Applicable	30 lb / 15 kg			14 in x 12 in / 355 mm x 305mm	80501358
D71XW25WR3	IP66; NEMA 4X	50 lb / 25 kg	0.005 lb / 2 g	0.01 lb / 5 g	12 in x 12 in / 305 mm x 305 mm	80501538
D71XW30HR1	Not Applicable	60 lb / 30 kg			14 in x 12 in / 355 mm x 305 mm	80501359
D71XW50WL4	IP66; NEMA 4X	100 lb / 50 kg	0.01 lb / 5 g	0.02 lb / 10 g	18 in x 18 in / 457 mm x 457 mm	80501539
D71XW60HR1	Not Applicable	150 lb / 60 kg			14 in x 12 in / 355 mm x 305 mm	80501360
D71XW60HL2			19.7 in x 15.7 in / 500 mm x 400 mm	80501361		
D71XW100HL2	IP66; NEMA 4X	250 lb / 100 kg	0.02 lb / 10 g	0.1 lb / 50 g	19.7 in x 15.7 in / 500 mm x 400 mm	80501362
D71XW100WL4					18 in x 18 in / 457 mm x 457 mm	80501540
D71XW150HX2	Not Applicable	300 lb / 150 kg	0.05 lb / 20 g	0.2 lb / 100 g	21.7 in x 16.5 in / 550 mm x 420 mm	80501363
D71XW250WX4	IP66; NEMA 4X	500 lb / 250 kg			24 in x 24 in / 610 mm x 610 mm	80501541
D71XW300HX2	Not Applicable	600 lb / 300 kg			21.7 in x 16.5 in / 550 mm x 420 mm	80501364

Accessories	Item No.
Printer, Impact, SF40A, AM	30064203
Printer, Thermal, STP-103, US (requires 80500525)	80251992
PCBA Kit, Alibi Memory, R71 T71	80500503
Cable, RS232, CKW TxxXW	80500552
Relay Kit, AC, T51 T71	80500720
Wheel Kit, Defender up to 600 lb / 300 kg capacity	30372146

Accessories	Item No.
Relay Kit, DC, T51 T71	80500727
Rechargeable Battery Kit, T51 T71	80500729
RS422/485 Kit, T51 T71	80500731
RS232 Kit, T51 T71	80500733
Wall Mount Kit, SST, T51XW T71XW	80500735
Software, Winwedge	80850080
Column Kit, Painted, Floor Stand	30047153
Column Kit, Stainless Steel, Floor Stand	30047154



Defender® 7000

High Performance Bench Scales for Advanced Applications

- Defender 7000 has advanced features such as accumulation mode, a 128-item library and optional alibi memory capability, as well as a 1:15,000 maximum displayed resolution.
- This advanced scale has dual-scale capabilities in which it can display the weights from two platforms and is powerful enough to drive up to 8 - 350 ohm load cells per platform.
- The ultra-durable Defender 7000 has a stainless steel platform, painted form-and-weld frame, column, and indicator bracket, aluminum IP67 load cell as well as an ABS indicator.

- Application** Weighing, Parts Counting, Percent Weighing, Checkweighing, Dynamic/Animal Weighing, Accumulation, Display Hold
- Display** Backlit liquid crystal display (LCD) with secondary information line, 3 color Checkweighing LEDs
- Operation** Power cord (included) or 6 C (LR14) batteries (not included) or rechargeable battery (accessory sold separately)
- Communication** Easy access communication port including RS232 (included) and 2nd RS232 or RS422/RS485 (accessories sold separately). GLP/GMP data output with real-time clock.
- Construction** ABS plastic indicator with reversible rear cover, painted steel wall bracket and column, painted steel 304 grade stainless steel platform with black polyurethane painted steel form-and-weld frame, IP67 aluminum load cell, non-slip adjustable rubber feet
- Design Features** Alibi memory kit (accessory sold separately), 150% overload capacity protection, five operating languages, NTEP Certified and Measurement Canada Approved



For a Limited Time

Model	Capacity	Readability	Certified Readability	Platform Size	Item No.
D71P10QR1	25 lb / 10 kg	0.002 lb / 1 g	0.005 lb / 2 g	12 in x 12 in / 305 mm x 305 mm	80501477
D71P15HR1	30 lb / 15 kg		0.01 lb / 5 g	14 in x 12 in / 355 mm x 305 mm	80501303
D71P25QR1	50 lb / 25 kg	0.005 lb / 2 g	0.02 lb / 10 g	12 in x 12 in / 305 mm x 305 mm	80501478
D71P30HR1	60 lb / 30 kg			14 in x 12 in / 355 mm x 305 mm	80501304
D71P50QL2	100 lb / 50 kg	0.01 lb / 5 g	0.05 lb / 20 g	18 in x 18 in / 457 mm x 457 mm	80501479
D71P60HR1	150 lb / 60 kg			14 in x 12 in / 355 mm x 305 mm	80501305
D71P60HL2				19.7 in x 15.7 in / 500 mm x 400 mm	80501306
D71P100HL2	250 lb / 100 kg	0.02 lb / 10 g	0.1 lb / 50 g	19.7 in x 15.7 in / 500 mm x 400 mm	80501307
D71P100QL2				18 in x 18 in / 457 mm x 457 mm	80501480
D71P150HX2	300 lb / 150 kg	0.05 lb / 20 g	0.2 lb / 100 g	21.7 in x 16.5 in / 550 mm x 420 mm	80501308
D71P250QX2	500 lb / 250 kg			24 in x 24 in / 610 mm x 610 mm	80501481
D71P300HX2	600 lb / 300 kg			21.7 in x 16.5 in / 550 mm x 420 mm	80501309

Accessories	Item No.
Printer, Impact, SF40A, AM	30064203
Wall Mount Kit, Painted, T51P T71P	72200227
Printer, Thermal, STP-103, US (requires 80500525)	80251992
PCBA Kit, Alibi Memory, R71 T71	80500503
Cable, RS232, IBM 9P, AV DV MB Ranger	80500525
Relay Kit, AC, T51 T71	80500720
Column Kit, Painted, Floor Stand	30047153
Column Kit, Stainless Steel, Floor Stand	30047154
Wheel Kit, Defender up to 600 lb / 300 kg capacity	30372146

Accessories	Item No.
Base Mount Kit, Painted, T51P T71P	80500722
Relay Kit, DC, T51 T71	80500727
Rechargeable Battery Kit, T51 T71	80500729
RS422/485 Kit, T51 T71	80500731
RS232 Kit, T51 T71	80500733
Cable Kit, Loadcell Adapter, T51 T71	80500736
Software, Winwedge	80850080
Interface Kit, RS232-USB	30304101
Interface Kit, RS232-Ethernet	30304102

Accumulation
 Checkweighing
 Display Hold
 Dynamic Weighing
 Parts Counting

Audible Alerts
 Auto Shut-Off
 Backlight
 Battery Power
 Low Battery Indicator

Environmental Filters
 External Analog Base Input
 Multi-Language
 Overload Protection
 Overload/Underload Indicators

GLP Data Output
 GMP/GLP
 LED Checkweighing Indicator
 Level Indicator
 Rechargeable Battery
 Software Lockout
 Stability Indicator
 Time/Date

NTEP Certified
 Measurement Canada Approved

Defender® 7000 Low Profile

Multi-Functional, High Quality Modular Scale For Advanced Applications



For a Limited Time

- Full alphanumeric keypad, dual-line display supporting English, Spanish or French text, Checkweighing LEDs.
- Advanced parts counting with dual-scale, dynamic weighing, percent weighing, display hold, Checkweighing, accumulation, time/date, temporary expanded 10x readability mode, library mode with 128 memory locations.
- GMP data output with date, time user ID, project ID and scale ID, statistics, lb, oz, lb:oz, g, kg, metric tonnes, user-defined custom unit.

- Application** Weighing, Display Hold, Dynamic Weighing, Counting, Checkweighing, Percent Weighing, Accumulation, Library of up to 128 items, Optional Alibi Memory
- Display** LCD display with white LED backlight, alphanumeric line and multi-language, plus 3 color checkweigh LED
- Operation** Internal universal power supply or 6 x C batteries or optional internal NiMH rechargeable battery
- Communication** RS232 Interface with GMP, Time-Date, optional RS422/485, AC/DC Relay, 2nd RS232
- Construction** ABS Indicator, 304 grade stainless steel platform pan with black polyurethane painted steel form-and weld frame, IP67 aluminium load cell, base mount bracket included
- Design Features** Alpha numeric keypad on indicator, platform with 5 or 6 point overload stops for 150% safe overload protection, NTEP Certified and Measurement Canada Approved

Model	Capacity	Readability	Certified Readability	Platform Size	Item No.
D71P10QR5	25 lb / 10 kg	0.002 lb / 1 g	0.005 lb / 2 g	12 in x 12 in / 305 mm x 305 mm	80501487
D71P15HR5	30 lb / 15 kg		0.01 lb / 5 g	14 in x 12 in / 355 mm x 305 mm	80501324
D71P25QR5	50 lb / 25 kg	0.005 lb / 2 g		0.02 lb / 10 g	12 in x 12 in / 305 mm x 305 mm
D71P30HR5	60 lb / 30 kg		14 in x 12 in / 355 mm x 305 mm		80501325
D71P50QL5	100 lb / 50 kg	0.01 lb / 5 g	0.05 lb / 20 g	18 in x 18 in / 457 mm x 457 mm	80501489
D71P60HR5	150 lb / 60 kg			14 in x 12 in / 355 mm x 305 mm	80501326
D71P60HL5				19.7 in x 15.7 in / 500 mm x 400 mm	80501327
D71P100HL5	250 lb / 100 kg	0.02 lb / 10 g	0.1 lb / 50 g	19.7 in x 15.7 in / 500 mm x 400 mm	80501328
D71P100QL5				18 in x 18 in / 457 mm x 457 mm	80501490
D71P150HX5	300 lb / 150 kg	0.05 lb / 20 g	0.2 lb / 100 g	21.7 in x 16.5 in / 550 mm x 420 mm	80501329
D71P250QX5	500 lb / 250 kg			24 in x 24 in / 610 mm x 610 mm	80501491
D71P300HX5	600 lb / 300 kg			21.7 in x 16.5 in / 550 mm x 420 mm	80501330

Accessories	Item No.
Printer, Impact, SF40A, AM	30064203
Wall Mount Kit, Painted, T51P T71P	72200227
Printer, Thermal, STP-103, US (requires 80500525)	80251992
PCBA Kit, Alibi Memory, R71 T71	80500503
Cable, RS232, IBM 9P, AV DV MB Ranger	80500525
Relay Kit, AC, T51 T71	80500720

Accessories	Item No.
Base Mount Kit, Painted, T51P T71P	80500722
Relay Kit, DC, T51 T71	80500727
Rechargeable Battery Kit, T51 T71	80500729
RS422/485 Kit, T51 T71	80500731
RS232 Kit, T51 T71	80500733
Software, Winwedge	80850080
Interface Kit, RS232-USB	30304101
Interface Kit, RS232-Ethernet	30304102



Defender® 5000

Multifunctional Bench Scales for Standard Industrial Applications

- Defender 5000 features software for parts counting, dynamic weighing, percent weighing, Checkweighing, display hold for large containers and can meet traceability requirements.
- Multiple connectivity capabilities include built-in RS232 bi-directional interface and external input as well as optional RS422/485, second RS232 and AC or DC relay.

- Application** Weighing, Parts Counting, Percent Weighing, Checkweighing, Dynamic/Animal Weighing, Display Hold
- Display** Backlit liquid crystal display (LCD), 3 color Checkweighing LEDs
- Operation** Power cord (included) or rechargeable battery (accessory sold separately)
- Communication** Easy access communication port including RS232 (included) and 2nd RS232 or RS422/RS485 (accessories sold separately). GLP/GMP data output with real-time clock.
- Construction** Bench scales with “W” bases are IP66 washdown protected with IP66 stainless steel indicator, IP67 stainless steel load cell, 304 stainless steel column, pan and form-and-weld base frame. Bench scales with “H” bases are IP66 washdown protected with IP66 stainless steel indicator, IP67 aluminum load cell, 304 grade stainless steel platform with black polyurethane painted steel column and form-and-weld frame.
- Design Features** 150% overload capacity protection, NTEP Certified and Measurement Canada Approved

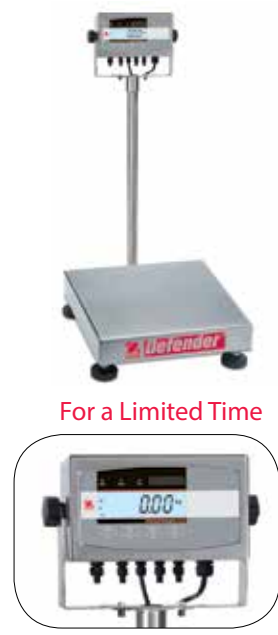

For a Limited Time

Model	Protection Rating	Capacity	Readability	Certified Readability	Platform Size	Item No.
D51XW10WR3	IP66;NEMA 4X	25 lb / 10 kg	0.002 lb / 1 g	0.005 lb / 2 g	12 in x 12 in / 305 mm x 305 mm	80501214
D51XW15HR1	Not Applicable	30 lb / 15 kg			14 in x 12 in / 355 mm x 305 mm	80500907
D51XW25WR3	IP66;NEMA 4X	50 lb / 25 kg	0.005 lb / 2 g	0.01 lb / 5 g	12 in x 12 in / 305 mm x 305 mm	80501215
D51XW30HR1	Not Applicable	60 lb / 30 kg			14 in x 12 in / 355 mm x 305 mm	80500908
D51XW50WL4	IP66;NEMA 4X	100 lb / 50 kg	0.01 lb / 5 g	0.02 lb / 10 g	18 in x 18 in / 457 mm x 457 mm	80501216
D51XW60HR1	Not Applicable	150 lb / 60 kg			14 in x 12 in / 355 mm x 305 mm	80500909
D51XW60HL2			19.7 in x 15.7 in / 500 mm x 400 mm	80500910		
D51XW100WL4	IP66;NEMA 4X	250 lb / 100 kg	0.02 lb / 10 g	0.05 lb / 20 g	18 in x 18 in / 457 mm x 457 mm	80501217
D51XW100HL2	Not Applicable				19.7 in x 15.7 in / 500 mm x 400 mm	80500911
D51XW150HX2		300 lb / 150 kg	0.05 lb / 20 g	0.1 lb / 50 g	21.7 in x 16.5 in / 550 mm x 420 mm	80500912
D51XW250WX4	IP66;NEMA 4X	500 lb / 250 kg			24 in x 24 in / 610 mm x 610 mm	80501218
D51XW300HX2	Not Applicable	600 lb / 300 kg	0.05 lb / 20 g	0.2 lb / 100 g	21.7 in x 16.5 in / 550 mm x 420 mm	80500913

Accessories	Item No.
Printer, Impact, SF40A, AM	30064203
Printer, Thermal, STP-103, US (requires 80500525)	80251992
Cable, RS232, CKW TxxXW	80500552
Relay Kit, AC, T51 T71	80500720
Relay Kit, DC, T51 T71	80500727
Wheel Kit, Defender up to 600 lb / 300 kg capacity	30372146

Accessories	Item No.
Rechargeable Battery Kit, T51 T71	80500729
RS422/485 Kit, T51 T71	80500731
RS232 Kit, T51 T71	80500733
Wall Mount Kit, SST, T51XW T71XW	80500735
Cable Kit, Loadcell Adapter, T51 T71	80500736
Software, Winwedge	80850080
Column Kit, Painted, Floor Stand	30047153
Column Kit, Stainless Steel, Floor Stand	30047154

Checkweighing
 Display Hold
 Dynamic Weighing
 Parts Counting
 Audible Alerts
 Auto Shut-Off
 Backlight
 Battery Power
 Environmental Filters
 GLP Data Output
 GMP/GLP
 Time/Date
 LED Checkweighing Indicator
 Stability Indicator
 NTEP Certified

Gross/Net/Tare
 Totalization
 Percent Weighing
 Weighing
 Level Indicator
 Leveling Feet
 Low Battery Indicator
 Multi-Language
 NEMA 4X IP66
 Overload Protection
 Overload/Underload Indicators
 Rechargeable Battery
 Software Lockout
 Measurement Canada Approved

Defender® 5000

Multifunctional Bench Scales for Standard Industrial Applications

- Defender 5000 features software for parts counting, dynamic weighing, percent weighing, Checkweighing, display hold for large containers and can meet traceability requirements.
- Multiple connectivity capabilities include built-in RS232 bi-directional interface and external input as well as optional RS422/485, second RS232 and AC or DC relay.
- The durable Defender 5000 has a stainless steel platform, painted form-and-weld frame, column, and indicator bracket, IP67 load cell, as well as an ABS plastic indicator.

Application Weighing, Parts Counting, Percent Weighing, Checkweighing, Dynamic/Animal Weighing, Display Hold

Display Backlit liquid crystal display (LCD), 3 color Checkweighing LEDs

Operation Power cord (included) or 6 C (LR14) batteries (not included) or rechargeable battery (accessory sold separately)

Communication Easy access communication port including RS232 (included) and 2nd RS232 or RS422/RS485 (accessories sold separately). GLP/GMP data output with real-time clock.

Construction ABS plastic indicator with reversible rear cover and painted steel column and wall bracket, 304 grade stainless steel platform with black polyurethane painted steel form-and-weld frame, IP67 aluminum load cell, non-slip adjustable rubber feet

Design Features 150% overload capacity protection, NTEP Certified and Measurement Canada Approved



For a Limited Time



Model	Capacity	Readability	Certified Readability	Platform Size	Item No.
D51P10QR1	25 lb / 10 kg	0.002 lb / 1 g	0.005 lb / 2 g	12 in x 12 in / 305 mm x 305 mm	80501154
D51P15HR1	30 lb / 15 kg		0.01 lb / 5 g	14 in x 12 in / 355 mm x 305 mm	80500511
D51P25QR1	50 lb / 25 kg	0.005 lb / 2 g	0.02 lb / 10 g	12 in x 12 in / 305 mm x 305 mm	80501155
D51P30HR1	60 lb / 30 kg			14 in x 12 in / 355 mm x 305 mm	80500512
D51P50QL2	100 lb / 50 kg	0.01 lb / 5 g	0.05 lb / 20 g	18 in x 18 in / 457 mm x 457 mm	80501156
D51P60HR1	150 lb / 60 kg			14 in x 12 in / 355 mm x 305 mm	80500513
D51P60HL2		19.7 in x 15.7 in / 500 mm x 400 mm	80500514		
D51P100QL2	250 lb / 100 kg	0.02 lb / 10 g	0.1 lb / 50 g	18 in x 18 in / 457 mm x 457 mm	80501157
D51P100HL2		0.05 lb / 20 g		19.7 in x 15.7 in / 500 mm x 400 mm	80500515
D51P150HX2	300 lb / 150 kg	0.02 lb / 10 g	0.2 lb / 100 g	21.7 in x 16.5 in / 550 mm x 420 mm	80251833
D51P250QX2	500 lb / 250 kg	0.05 lb / 20 g		24 in x 24 in / 610 mm x 610 mm	80501158
D51P300HX2	600 lb / 300 kg			21.7 in x 16.5 in / 550 mm x 420 mm	80500516

Accessories	Item No.
Printer, Impact, SF40A, AM	30064203
Printer, Thermal, STP-103, US (requires 80500525)	80251992
Cable, RS232, IBM 9P, AV DV MB Ranger	80500525
Cable, SF42-AV DV MB Ranger	80500571
Interface Kit, RS232-USB	30304101
Interface Kit, RS232-Ethernet	30304102
Wheel Kit, Defender up to 600 lb / 300 kg capacity	30372146

Accessories	Item No.
Relay Kit, AC, T51 T71	80500720
Base Mount Kit, Painted, T51P T71P	80500722
Relay Kit, DC, T51 T71	80500727
Rechargeable Battery Kit, T51 T71	80500729
RS422/485 Kit, T51 T71	80500731
RS232 Kit, T51 T71	80500733
Software, Winwedge	80850080
Column Kit, Painted, Floor Stand	30047153
Column Kit, Stainless Steel, Floor Stand	30047154



Defender® 5000 Low Profile

Smart Functionality and Durability for Industrial Applications



For a Limited Time

- Applications including dynamic weighing and Checkweighing
- Defender 5000 offers multiple weighing modes including counting, percent weighing, dynamic/animal weighing and Checkweighing to meet the needs of various applications and industries.
- Includes an internal power supply with universal line cord or can be powered by 6 C (LR14) batteries for up to 80 hours.

- Application** Weighing, Dynamic Weighing, Parts Counting, Checkweighing, Percent Weighing, Display Hold
- Display** Liquid Crystal Display (LCD) with white LED backlight plus 3 color checkweigh LED
- Operation** Internal Universal Power Supply, 6 x C (LR14) Batteries (Not Included) or Optional Internal NiMH Rechargeable Battery
- Communication** RS232 (Included), 2nd RS232 (Available as an Accessory), RS422/485 (Available as an Accessory)
- Construction** ABS indicator, 304 stainless steel platform, black polyurethane painted steel form- and weld frame, IP67 aluminium load cell, base mount bracket included
- Design Features** Platform with 5 or 6 point overload stops for 150% safe overload protection, NTEP Certified and Measurement Canada Approved

Model	Capacity	Readability	Certified Readability	Platform Size	Item No.
D51P10QR5	25 lb / 10 kg	0.002 lb / 1 g	0.005 lb / 2 g	12 in x 12 in / 305 mm x 305 mm	80501164
D51P15HR5	30 lb / 15 kg			14 in x 12 in / 355 mm x 305 mm	80500799
D51P25QR5	50 lb / 25 kg	0.005 lb / 2 g	0.01 lb / 5 g	12 in x 12 in / 305 mm x 305 mm	80501165
D51P30HR5	60 lb / 30 kg			14 in x 12 in / 355 mm x 305 mm	80500800
D51P50QL5	100 lb / 50 kg	0.01 lb / 5 g	0.02 lb / 10 g	18 in x 18 in / 457 mm x 457 mm	80501166
D51P60HR5	150 lb / 60 kg			14 in x 12 in / 355 mm x 305 mm	80500801
D51P60HL5		0.05 lb / 20 g	19.7 in x 15.7 in / 500 mm x 400 mm	80500802	
D51P100QL5	250 lb / 100 kg	0.02 lb / 10 g	0.1 lb / 50 g	18 in x 18 in / 457 mm x 457 mm	80501167
D51P100HL5				19.7 in x 15.7 in / 500 mm x 400 mm	80500803
D51P150HX5	300 lb / 150 kg	0.05 lb / 20 g	0.2 lb / 100 g	21.7 in x 16.5 in / 550 mm x 420 mm	80500804
D51P250QX5	500 lb / 250 kg			24 in x 24 in / 610 mm x 610 mm	80501168
D51P300HX5	600 lb / 300 kg			21.7 in x 16.5 in / 550 mm x 420 mm	80500805

Accessories	Item No.
Printer, Impact, SF40A, AM	30064203
Printer, Thermal, STP-103, US (requires 80500525)	80251992
Cable, RS232, IBM 9P, AV DV MB Ranger	80500525
Relay Kit, AC, T51 T71	80500720
Base Mount Kit, Painted, T51P T71P	80500722

Accessories	Item No.
Relay Kit, DC, T51 T71	80500727
Rechargeable Battery Kit, T51 T71	80500729
RS422/485 Kit, T51 T71	80500731
RS232 Kit, T51 T71	80500733
Software, Winwedge	80850080
Interface Kit, RS232-USB	30304101
Interface Kit, RS232-Ethernet	30304102



Defender® 3000 Washdown

Economical Stainless Steel Bench Scales for Basic Industrial Washdown Applications

- The NEMA 4X/IP65 stainless steel indicator can endure tough industrial elements while the internal rechargeable battery powers operation for 58 hours.
- The tough Defender 3000 has a stainless steel platform, stainless steel tubular frame, column and indicator bracket, IP67 stainless steel load cell.
- Simple operation, an easy-to-read display and even basic counting mode round out this industrial indicator, making it ideal for everyday basic industrial use.

- Application** Weighing, Parts Counting
- Display** Backlit liquid crystal display (LCD)
- Operation** Power cord (included) or rechargeable battery (included)
- Communication** Easy access communication port with RS232 interface (included)
- Construction** IP65 stainless steel indicator with hinged front cover, stainless steel column and wall bracket, 304 grade stainless steel platform with steel tubular frame, IP67 stainless steel load cell

Design Features 125% overload protection, NTEP Certified and Measurement Canada Approved



30 lb model available

Model	Protection Rating	Capacity	Readability	Certified Readability	Platform Size	Item No.
D32XW15VR	IP65 ; NEMA 4X	30 lb / 15 kg	0.005 lb / 2 g	0.01 lb / 5g	14 in x 12 in / 355 mm x 305 mm	30369114
D32XW30VR		66 lb / 30 kg	0.01 lb / 5 g	0.02 lb / 10 g	14 in x 12 in / 355 mm x 305 mm	83999817
D32XW60VR		132 lb / 60 kg	0.02 lb / 10 g	0.05 lb / 20 g	14 in x 12 in / 355 mm x 305 mm	83999818
D32XW60VL		21.7 in x 16.5 in / 550 mm x 420 mm	83999819			
D32XW150VL		330 lb / 150 kg	0.05 lb / 20 g	0.1 lb / 50 g	21.7 in x 16.5 in / 550 mm x 420 mm	83999820
D32XW150VX		25.6 in x 19.7 in / 650 mm x 500 mm	83999821			
D32XW300VX		660 lb / 300 kg	0.1 lb / 50 g	0.2 lb / 100 g	25.6 in x 19.7 in / 650 mm x 500 mm	83999822

Accessories	Item No.
Printer, Impact, SF40A, AM	30064203
Printer, Thermal, STP-103, US (requires 80500525)	80251992
Cable, RS232, CKW TxxXW	80500552
Software, Winwedge	80850080
Column Kit, Painted, Floor Stand	30047153
Column Kit, Stainless Steel, Floor Stand	30047154
Wheel Kit, Defender up to 600 lb / 300 kg capacity	30372146

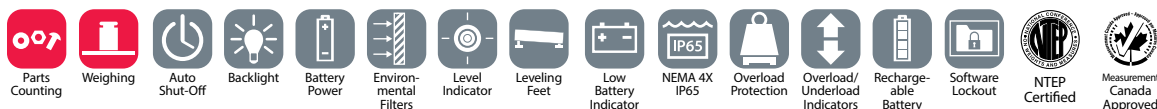

Defender® 3000

Economical Bench Scales for Basic Industrial Applications

- Defender 3000 is OIML approved, NTEP certified, and Measurement Canada approved for use in all legal-for-trade applications.
- The durable Defender 3000 has a 304 stainless steel platform, aluminum IP67 load cell, as well as a painted tubular steel frame, column and indicator bracket.
- The ultra-long-lasting internal rechargeable battery provides operation on a single charge for up to 120 hours, ensuring uninterrupted operation for five straight days.

- Application** Weighing, Parts Counting
- Display** Backlit liquid crystal display (LCD)
- Operation** AC adapter (included) or rechargeable battery (included)
- Communication** Easy access communication port with RS232 interface (included)
- Construction** ABS indicator with reversible rear cover, 304 grade stainless steel platform with painted steel tubular frame, IP67 aluminum load cell, self-adjusting stainless steel feet with removable rubber caps. Regular models have painted steel column and wall bracket, front mount models (Model ends in 5) have painted front mount.
- Design Features** 125% overload protection, NTEP Certified and Measurement Canada Approved



30 lb model available



Front mount handle models now available

Column Mount Models

Model	Capacity	Readability	Certified Readability	Platform Size	Item No.
D31P15BR	30 lb / 15 kg	0.005 lb / 2 g	0.01 lb / 5 g	14 in x 12 in / 355 mm x 305 mm	30369116
D31P30BR	66 lb / 30 kg	0.01 lb / 5 g	0.02 lb / 10 g	14 in x 12 in / 355 mm x 305 mm	83998111
D31P60BR	132 lb / 60 kg	0.02 lb / 10 g	0.05 lb / 20 g	14 in x 12 in / 355 mm x 305 mm	83998112
D31P60BL				21.7 in x 16.5 in / 550 mm x 420 mm	83998113
D31P150BL	330 lb / 150 kg	0.05 lb / 20 g	0.1 lb / 50 g	21.7 in x 16.5 in / 550 mm x 420 mm	83998114
D31P150BX				25.6 in x 19.7 in / 650 mm x 500 mm	83998115
D31P300BX	660 lb / 300 kg	0.1 lb / 50 g	0.2 lb / 100 g	25.6 in x 19.7 in / 650 mm x 500 mm	83998116

Front Mount Models

Model	Capacity	Readability	Certified Readability	Platform Size	Item No.
D31P15BR5	30 lb / 15 kg	0.005 lb / 2 g	0.01 lb / 5 g	14 in x 12 in / 355 mm x 305 mm	30490640
D31P30BR5	66 lb / 30 kg	0.01 lb / 5 g	0.02 lb / 10 g		30490641
D31P60BR5	132 lb / 60 kg	0.02 lb / 10 g	0.05 lb / 20 g		30490642
D31P60BL5				30490643	
D31P150BL5	330 lb / 150 kg	0.05 lb / 20 g	0.1 lb / 50 g	21.7 in x 16.5 in / 550 mm x 420 mm	30490644

Accessories	Item No.
Printer, Impact, SF40A, AM	30064203
Printer, Thermal, STP-103, US (requires 80500525)	80251992
Cable, RS232, IBM 9P, AV DV MB Ranger	80500525
Software, Winwedge	80850080
Column Kit, Painted, Floor Stand	30047153
Column Kit, Stainless Steel, Floor Stand	30047154
Interface Kit, RS232-USB	30304101
Interface Kit, RS232-Ethernet	30304102
Wheel Kit, Defender up to 600 lb / 300 kg capacity	30372146
Handle Kit, D3K	30381321



Defender® Digital Field Test Scale

Portable Precision Ready for the Field

- Designed for precision material testing in the construction industry with metal carrying case and internal 70-hour rechargeable battery.
- Provides capacity of 165lb and readability of 0.05lb for weighing test samples of concrete, asphalt and soil.
- Durably constructed with painted steel base and tough ABS indicator housing.



NEW

- Application** Weighing, Counting
- Display** Backlit LCD display
- Operation** 9 VDC, AC wall adapter and internal rechargeable battery included
- Communication** Standard RS232; Optional Ethernet or USB available with RS232 kits
- Construction** Painted steel base, ABS plastic indicator, metal carrying case
- Design Features** Bright backlit display, internal rechargeable battery with 70 hours use between recharges, metal case with locking latches, 9 ft. indicator cord to base, 9ft. Cord from AC adapter to indicator, in-use cover included

Model	Capacity	Readability	Platform Size	Item No.
D31P75SD	165 lb / 75 kg	0.05 lb / 0.02 kg	12.4 × 11 in. / 316 × 280 mm	30448500

Accessories	Item No.
Interface Kit, RS232-USB	30304101
Interface Kit, RS232-Ethernet	30304102
Printer SF40A (includes RS232 cable)	30064203
Printer, Thermal, STP-103, US (requires 80500525)	80251992
RS232 Interface Cable to PC 9-pin	80500525
Software, Winwedge	80850080

ES Series

Multipurpose Low Profile Shipping Scale

- With different size low-profile platforms, there are ES scales that can accommodate weighing loads of different shapes and sizes.
- The three-way mounting bracket allows you to mount the indicator to the scale base, above the scale platform, or on any vertical surface for maximum flexibility.
- The sturdy and durable ES has a stainless steel platform and painted steel frame.

Application Weighing

Display Liquid crystal display (LCD)

Operation AC adapter (included) or 6 AA batteries (not included)

Construction ABS indicator, stainless steel platform, painted steel frame, 3 way mounting bracket

Design Features Auto-zero tracking, auto shut-off



Model	Capacity	Readability	Platform Size	Item No.
ES6R	13 lb / 6 kg	0.005 lb / 0.002 kg	12.2 in x 10.8 in / 310 mm x 270 mm	71138830
ES30R	66 lb / 30 kg	0.05 lb / 0.01 kg	12.2 in x 10.8 in / 310 mm x 270 mm	71138831
ES50R	110 lb / 50 kg	0.05 lb / 0.02 kg	12.2 in x 10.8 in / 310 mm x 270 mm	71138832
ES50L			20.5 in x 15.7 in / 520 mm x 400 mm	71138833
ES100L	220 lb / 100 kg	0.1 lb / 0.05 kg	20.5 in x 15.7 in / 520 mm x 400 mm	71138834
ES200L	440 lb / 200 kg	0.2 lb / 0.1 kg	20.5 in x 15.7 in / 520 mm x 400 mm	71138835



Weighing



Auto Shut-Off



Battery Power



Low Battery Indicator



Overload/Underload Indicators



Stability Indicator

SD Series

Rugged Economical Shipping Scales

- The SD is available in three capacities of 35 kg, 75 kg and 200 kg and two platform sizes to meet the weighing needs of jobs of different physical sizes and capacities.
- SD's painted steel platform and frame provides sturdy support for all materials placed on the platform.
- SD not only provides accurate general weight determination but also has the software to support dynamic/animal weighing and display hold.
- New WeighAlert mode flashes weight display when weight on platform is greater than 70lb and less than 151lb, alerting user that package is too heavy for USPS service but below Less-Than-Truckload (LTL) limit for shipping.



WeighAlert mode available



- Application** Weighing, Animal/Dynamic Weighing, Display Hold
- Display** Liquid crystal display (LCD)
- Operation** AC adapter (included) or 3 C (LR14) batteries (not included)
- Construction** ABS indicator, painted steel base, raised, embossed tread platform (non-L models), rubber feet (adjustable on L models), mounting brackets, transportation handle, extendable coiled cable
- Design Features** Transportation handle on packaging (non-L models)

Model	Capacity	Readability	Platform Size	Item No.
SD35	77 lb / 35 kg	0.05 lb / 0.02 kg	12.4 in x 11 in / 316 mm x 280 mm	83998234
SD75	165 lb / 75 kg	0.1 lb / 0.05 kg	12.4 in x 11 in / 316 mm x 280 mm	83998235
SD75L			20.5 in x 15.7 in / 520 mm x 400 mm	83998236
SD200	440 lb / 200 kg	0.2 lb / 0.1 kg	12.4 in x 11 in / 316 mm x 280 mm	83998237
SD200L			20.5 in x 15.7 in / 520 mm x 400 mm	83998238

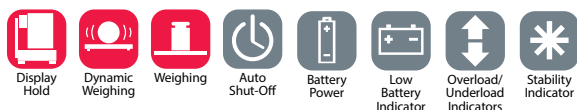

Ranger® 7000

Simplifying Even the Most Complex Industrial Applications

- Ten advanced modes with up to 2,000 item library simplify complex applications and minimize the need for manual calculations and it can also control peripheral devices and/or a scale platform with option kit.
- With one second stabilization time, up to 350,000d display resolution and Legal-for-Trade certifications, Ranger 7000's precision cannot be matched by any scale in its class.
- Ranger 7000 was developed to thrive in rugged and harsh industrial environments. This modular scale was built with IP54 metal housing and sealed metal indicator to ensure durability.



With added Counting Features

- Application** Weighing, Parts Counting with Auto Optimization, Percent Weighing, Advanced Checkweighing, Animal/Dynamic Weighing, Display Hold, Filling, Formulation, Differential Weighing, Density Determination, Sieve Analysis
- Display** 4.3" (109 mm) Full-color WQVGA graphic display with user-controlled brightness
- Operation** AC power (included) or rechargeable battery (accessory sold separately)
- Communication** Easy access communication port including standard USB and RS232 (included) and an optional third port of RS232 or Ethernet (accessories sold separately). GLP/ GMP Data Output with Real Time Clock. Data Transfer Function.
- Construction** Modular design, die-cast housing, removable stainless steel platform, integral weigh below hook, menu lock switch, level indicator
- Design Features** Checkweighing lights with selectable operation and audible signal settings, several selectable operating languages, selectable environmental and auto-print settings, stability indicator, overload/underload indicators, selectable brightness settings, auto-; Checkweighing lights with selectable operation and audible signal settings, several selectable operating languages, selectable environmental and auto-print settings, stability indicator, overload/underload indicators, selectable brightness settings, auto-dim, auto-sleep, auto tare, chain tare.

Model	InCal™	Capacity	Readability	Certified Readability	Platform Size	Item No.
R71MD3		6 lb / 3 kg	0.0001 lb / 0.05 g	0.001 lb / 0.5 g	11 in x 11 in / 280 mm x 280 mm	30070289
R71MD6		15 lb / 6 kg	0.0002 lb / 0.1 g	0.002 lb / 1 g	11 in x 11 in / 280 mm x 280 mm	30070310
R71MD15		30 lb / 15 kg	0.0005 lb / 0.2 g	0.005 lb / 2 g	12.2 in x 14.8 in / 311 mm x 377 mm	30070311
R71MD35		70 lb / 35 kg	0.001 lb / 0.5 g	0.01 lb / 5 g	12.2 in x 14.8 in / 311 mm x 377 mm	30070312
R71MD60		150 lb / 60 kg	0.002 lb / 1 g	0.02 lb / 10 g	12.2 in x 14.8 in / 311 mm x 377 mm	30212873

Model	InCal™	Capacity	Readability	Certified Readability	Platform Size	Item No.
R71MHD3	•	6 lb / 3 kg	0.00002 lb / 0.01 g	0.0002 lb / 0.1 g	9.4 in x 9.4 in / 240 mm x 240 mm	30088840
R71MHD6	•	15 lb / 6 kg	0.00005 lb / 0.02 g	0.0005 lb / 0.2 g	9.4 in x 9.4 in / 240 mm x 240 mm	30088841
R71MHD15	•	30 lb / 15 kg	0.0002 lb / 0.1 g	0.002 lb / 1 g	12.2 in x 14.8 in / 311 mm x 377 mm	30088842
R71MHD35	•	70 lb / 35 kg	0.0002 lb / 0.1 g	0.002 lb / 1 g	12.2 in x 14.8 in / 311 mm x 377 mm	30088843

Accessories	Item No.
Ethernet Kit, R31 RC31 R71 V71	30037447
RS232 Kit, R31 RC31 R71 V71	30037448
Rechargeable Battery, EX-HiCap R71	30041295
Printer, Impact, SF40A, AM	30064203
Column Kit, Painted, R71	30095408
PCBA Kit, 2nd Platform, R71	30097590

Accessories	Item No.
Discrete I/O Kit, 2-In/4-Out, R71	30097591
Cable, Extension, 9m, R71	30101495
PCBA Kit, Alibi Memory, R71 T71	80500503
Accessory, In Use Cover, R71	30135320
Cable, RS232, IBM 9P, AV DV MB Ranger	80500525
Software, Winwedge	80850080

* Not in parts counting mode

Accumulation	Checkweighing	Density Determination	Differential Weighing	Display Hold	Dynamic Weighing	Filling	Audible Alerts	Battery Power	Environmental Filters	External Analog Base Input	GLP Data Output	GMP/GLP	Internal Calibration	LED Checkweighing Indicator	NTEP Certified *
Formulation	Gross/Net/Tare	Parts Counting	Percent Weighing	Statistics	Totalization	Weighing	Level Indicator	Leveling Feet	Overload/Underload Indicators	Rechargeable Battery	Stability Indicator	Time/Date	Weigh Below Hook	Measurement Canada Approved *	

Ranger® Count 4000

The Best Value for Durable Industrial Counting

- Sturdy metal housing and slip-resistant rubber feet provide the protection and stability necessary for tough industrial weighing while extending the scale's usable life.
- Accurate weighing and counting performance is assured through Ranger Count 4000's 1:1,500,000 internal counting resolution, 30 item library and auto-optimization software that reduces errors and ensures accuracy.
- The combination of SmarText™ software, a centrally located count display and dedicated Sample & Tare keys make Ranger Count 4000 very easy to operate.



- Application** Weighing, Parts Counting with Auto Optimization, Checkweighing, Accumulation
- Display** 3 window backlit liquid crystal display (LCD), 3 color Checkweighing LEDs
- Operation** AC power (included) or rechargeable battery (included)
- Communication** Easy access communication port including standard RS232 (included) and second RS232, USB or Ethernet (accessories sold separately)
- Construction** Rugged Cast Aluminum Housing, Stainless Steel Platform
- Design Features** Cast Aluminum Housing, stainless steel platform, sealed front panel, menu lockswitch, up front level indicator, adjustable leveling feet, selectable environmental and auto-print settings, stability indicator, overload and underload indicators, low battery indicator, auto shut-off, auto tare

Model	Capacity	Readability	Certified Readability	Platform Size	Item No.
RC41M3	6 lb / 3 g	0.0002 lb / 0.1 g	0.002 lb / 1 g	8.9 in x 11.8 in / 225 mm x 300 mm	30236779
RC41M6	15 lb / 6 kg	0.0005 lb / 0.2 g	0.005 lb / 2 g	8.9 in x 11.8 in / 225 mm x 300 mm	30236940
RC41M15	30 lb / 15 kg	0.001 lb / 0.5 g	0.01 lb / 5 g	8.9 in x 11.8 in / 225 mm x 300 mm	30236941
RC41M30	60 lb / 30 kg	0.002 lb / 1 g	0.02 lb / 10 g	8.9 in x 11.8 in / 225 mm x 300 mm	30236942

Accessories	Item No.
PCBA Kit, 2nd Platform, RC31 RC41	30037446
Ethernet Kit, R31 RC31 R71 V71 RC41	30037447
RS232 Kit, R31 RC31 R71 V71 RC41	30037448
USB Kit, R31 RC31 V71 RC41	30037449
In Use Cover	30240697

Accessories	Item No.
Printer, Impact, SF40A, AM	30064203
Printer, Thermal, STP-103, US (requires 80500525)	80251992
Cable, RS232, IBM 9P, AV DV MB Ranger	80500525
Software, Winwedge	80850080

* Not in parts counting mode

Ranger® Count 3000

Multipurpose Compact Counting Scales for Basic Industrial Applications

- Accurate weighing and counting performance is assured through Ranger Count 3000's high resolution, 30 item library function and auto-optimization software that reduces errors.
- The 3 backlit LCD displays, including a centrally located count display, along with an easy-to-navigate menu, make Ranger Count 3000 easy to use in multi-step counting operations.
- Ranger Count 3000 produces accurate results within one second and virtually eliminates your wait time and allows you to move at a pace determined by you, not your weighing equipment.



- Application** Weighing, Parts Counting with Auto Optimization, Checkweighing, Accumulation
- Display** 3 window backlit liquid crystal display (LCD), 3 color Checkweighing LEDs
- Operation** AC power (included) or rechargeable battery (included)
- Communication** Easy access communication port including standard RS232 (included) and second RS232, USB or Ethernet (accessories sold separately)
- Construction** ABS housing, stainless steel platform, numeric keypad, menu lock switch, up front level indicator, transportation handle
- Design Features** 30 item library, 210 hours of battery life, 3 LED Checkweighing lights with selectable operation and audible signal settings, auto tare, selectable environmental and auto-print settings, auto shut-off, optional 2nd scale input



Model	Capacity	Readability	Certified Readability	Platform Size	Item No.
RC31P1502	3 lb / 1.5 kg	0.0001 lb / 0.05 g	0.001 lb / 0.5 g	8.9 in x 11.8 in / 225 mm x 300 mm	30031787
RC31P3	6 lb / 3 kg	0.0002 lb / 0.1 g	0.002 lb / 1 g	8.9 in x 11.8 in / 225 mm x 300 mm	30031788
RC31P6	15 lb / 6 kg	0.0005 lb / 0.2 g	0.005 lb / 2 g	8.9 in x 11.8 in / 225 mm x 300 mm	30031789
RC31P15	30 lb / 15 kg	0.001 lb / 0.5 g	0.01 lb / 5 g	8.9 in x 11.8 in / 225 mm x 300 mm	30031790
RC31P30	60 lb / 30 kg	0.002 lb / 1 g	0.02 lb / 10 g	8.9 in x 11.8 in / 225 mm x 300 mm	30031791

Accessories	Item No.
PCBA Kit, 2nd Platform, RC31	30037446
Ethernet Kit, R31 RC31 R71 V71	30037447
RS232 Kit, R31 RC31 R71 V71	30037448
USB Kit, R31 RC31 V71	30037449
Hook, R21 RC21 R31 RC31 V71	30037450

Accessories	Item No.
In-Use-Cover, R21 RC21 R31 RC31	30037451
Printer, Impact, SF40A, AM	30064203
Printer, Thermal, STP-103, US (requires 80500525)	80251992
Cable, RS232, IBM 9P, AV DV MB Ranger	80500525
Carrying Case, TR TC R31 TC31 RC31	80850084
Software, Winwedge	80850080

* Not in parts counting mode

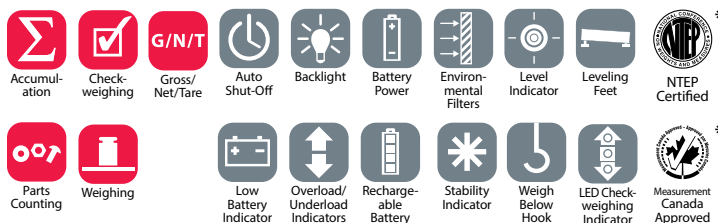

Ranger® 7000

Simplifying Even the Most Complex Industrial Applications

- Ten advanced modes with up to 2,000 item library simplify complex applications and minimize the need for manual calculations and it can also control peripheral devices and/or a scale platform with option kit.
- With one second stabilization time, up to 350,000d display resolution and Legal-for-Trade certifications, Ranger 7000's precision cannot be matched by any scale in its class.
- Ranger 7000 was developed to thrive in rugged and harsh industrial environments. This modular scale was built with IP54 metal housing and sealed metal indicator to ensure durability.

Application Weighing, Parts Counting with Auto Optimization, Percent Weighing, Advanced Checkweighing, Animal/Dynamic Weighing, Display Hold, Filling, Formulation, Differential Weighing, Density Determination, Sieve Analysis Mode with customizable printout

Display 4.3" (109 mm) Full-color WQVGA graphic display with user-controlled brightness

Operation AC power (included) or rechargeable battery (accessory sold separately)

Communication Easy access communication port including standard USB and RS232 (included) and an optional third port of RS232 or Ethernet (accessories sold separately). GLP/ GMP Data Output with Real Time Clock. Data Transfer Function.

Construction Modular design, die-cast housing, removable stainless steel platform, integral weigh below hook, menu lock switch, level indicator

Design Features Checkweighing lights with selectable operation and audible signal settings, several selectable operating languages, selectable environmental and auto-print settings, stability indicator, overload/underload indicators, selectable brightness settings, auto-; Checkweighing lights with selectable operation and audible signal settings, several selectable operating languages, selectable environmental and auto-print settings, stability indicator, overload/underload indicators, selectable brightness settings, auto-dim, auto-sleep, auto tare, chain tare, NTEP Certified and Measurement Canada Approved



With Sieve Analysis Mode



Model	InCal™	Capacity	Readability	Certified Readability	Platform Size	Item No.
R71MD3		6 lb / 3 kg	0.0001 lb / 0.05 g	0.001 lb / 0.5 g	11 in x 11 in / 280 mm x 280 mm	30070289
R71MD6		15 lb / 6 kg	0.0002 lb / 0.1 g	0.002 lb / 1 g	11 in x 11 in / 280 mm x 280 mm	30070310
R71MD15		30 lb / 15 kg	0.0005 lb / 0.2 g	0.005 lb / 2 g	12.2 in x 14.8 in / 311 mm x 377 mm	30070311
R71MD35		70 lb / 35 kg	0.001 lb / 0.5 g	0.01 lb / 5 g	12.2 in x 14.8 in / 311 mm x 377 mm	30070312
R71MD60		150 lb / 60 kg	0.002 lb / 1 g	0.02 lb / 10 g	12.2 in x 14.8 in / 311 mm x 377 mm	30212873

Model	InCal™	Capacity	Readability	Certified Readability	Platform Size	Item No.
R71MHD3	•	6 lb / 3 kg	0.00002 lb / 0.01 g	0.0002 lb / 0.1 g	9.4 in x 9.4 in / 240 mm x 240 mm	30088840
R71MHD6	•	15 lb / 6 kg	0.00005 lb / 0.02 g	0.0005 lb / 0.2 g	9.4 in x 9.4 in / 240 mm x 240 mm	30088841
R71MHD15	•	30 lb / 15 kg	0.0002 lb / 0.1 g	0.002 lb / 1 g	12.2 in x 14.8 in / 311 mm x 377 mm	30088842
R71MHD35	•	70 lb / 35 kg	0.0002 lb / 0.1 g	0.002 lb / 1 g	12.2 in x 14.8 in / 311 mm x 377 mm	30088843

Accessories	Item No.
Ethernet Kit, R31 RC31 R71 V71	30037447
RS232 Kit, R31 RC31 R71 V71	30037448
Rechargeable Battery, EX-HiCap R71	30041295
Printer, Impact, SF40A, AM	30064203
Column Kit, Painted, R71	30095408
PCBA Kit, 2nd Platform, R71	30097590

Accessories	Item No.
Discrete I/O Kit, 2-In/4-Out, R71	30097591
Cable, Extension, 9m, R71	30101495
PCBA Kit, Alibi Memory, R71 T71	80500503
Accessory, In Use Cover, R71	30135320
Cable, RS232, IBM 9P, AV DV MB Ranger	80500525
Software, Winwedge	80850080

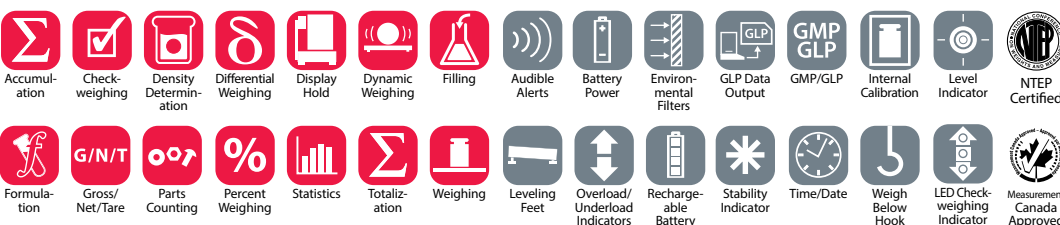

Compact Bench Scales

Ranger® 4000

The Best Value for Durable Industrial Weighing

- Sturdy metal housing and slip-resistant rubber feet provide the protection and stability necessary for tough industrial weighing, while extending the product's usable life.
- The largest, white LED display on any scale in its class, combined with Checkweighing LEDs and audible indicators, make Ranger 4000 highly functional in loud and dim industrial settings.
- Spend time on your work, not on mastering the technicalities of the scale. SmarText™ software makes scale setup and use very simple.



- Application** Weighing, Parts Counting, Checkweighing, Percent Weighing, Animal/Dynamic Weighing, Display Hold, Accumulation
- Display** Light-emitting diode display (LED), 3 color Checkweighing LEDs
- Operation** AC power (included) or rechargeable battery (included)
- Communication** Easy access communication port including standard RS232 (included) and second RS232, USB or Ethernet (accessories sold separately)
- Construction** Rugged Cast Aluminum Housing, Stainless Steel Platform
- Design Features** Cast aluminum housing, stainless steel platform, integral weigh-below hook, sealed front panel, menu lock switch, up front level indicator, adjustable leveling feet, selectable environmental and auto-print settings, stability indicator, overload and underload indicators, low battery indicator, auto shut-off, auto tare, NTEP Certified and Measurement Canada Approved

Model	Capacity	Readability	Certified Readability	Platform Size	Item No.
R41ME3	6 lb / 3 kg	0.0002 lb / 0.1 g	0.002 lb / 1 g	8.9 in x 11.8 in / 225 mm x 300 mm	30236775
R41ME6	15 lb / 6 kg	0.0005 lb / 0.2 g	0.005 lb / 2 g	8.9 in x 11.8 in / 225 mm x 300 mm	30236776
R41ME15	30 lb / 15 kg	0.001 lb / 0.5 g	0.01 lb / 5 g	8.9 in x 11.8 in / 225 mm x 300 mm	30236777
R41ME30	60 lb / 30 kg	0.002 lb / 1 g	0.02 lb / 10 g	8.9 in x 11.8 in / 225 mm x 300 mm	30236778

Accessories	Item No.
PCBA Kit, 2nd Platform, RC31 R41	30037446
Ethernet Kit, R31 RC31 R71 V71 R41	30037447
RS232 Kit, R31 RC31 R71 V71 R41	30037448
USB Kit, R31 RC31 V71 R41	30037449
In Use Cover	30240697

Accessories	Item No.
Printer, Impact, SF40A, AM	30064203
Printer, Thermal, STP-103, US (requires 80500525)	80251992
Cable, RS232, IBM 9P, AV DV MB Ranger	80500525
Software, Winwedge	80850080

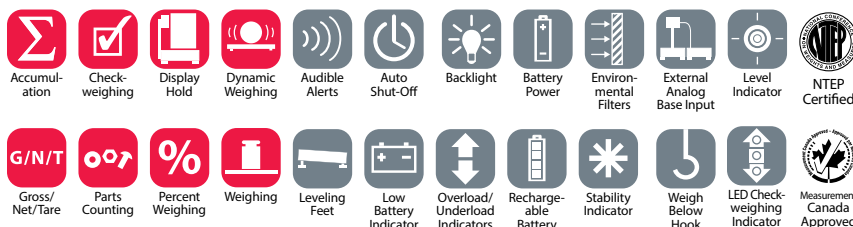

Ranger® 3000

Multipurpose Compact Bench Scales for Basic Industrial Applications

- Ranger 3000 has the largest display in its class and is equipped with Checkweighing LEDs and backlit LCD displays which make it functional in almost any working condition.
- The most user friendly scale on the market with easy setup that ensures your valuable time is not wasted and you're working as proficiently as possible.
- Ranger 3000 produces accurate results within one second, virtually eliminates your wait time, and allows you to move at a pace determined by you, not your weighing equipment.



- Application** Weighing, Parts Counting, Checkweighing, Percent Weighing, Animal/Dynamic Weighing, Display Hold, Accumulation
- Display** Backlit liquid crystal display (LCD), 3 color Checkweighing LEDs
- Operation** AC power (included) or rechargeable battery (included)
- Communication** Easy access communication port including standard RS232 (included) and second RS232, USB or Ethernet (accessories sold separately)
- Construction** ABS housing, stainless steel platform, menu lock switch, up-front level indicator, integral weigh-below hook, transportation handle
- Design Features** 210 hours of battery life, 3 LED Checkweighing lights with selectable operation and audible signal settings, selectable environmental and auto-print settings, auto shut-off, auto tare, NTEP Certified and Measurement Canada Approved

Model	Capacity	Readability	Certified Readability	Platform Size	Item No.
R31P1502	3 lb / 1.5 kg	0.0001 lb / 0.05 g	0.001 lb / 0.5 g	8.9 in x 11.8 in / 225 mm x 300 mm	30031707
R31P3	6 lb / 3 kg	0.0002 lb / 0.1 g	0.002 lb / 1 g	8.9 in x 11.8 in / 225 mm x 300 mm	30031708
R31P6	15 lb / 6 kg	0.0005 lb / 0.2 g	0.005 lb / 2 g	8.9 in x 11.8 in / 225 mm x 300 mm	30031709
R31P15	30 lb / 15 kg	0.001 lb / 0.5 g	0.01 lb / 5 g	8.9 in x 11.8 in / 225 mm x 300 mm	30031710
R31P30	60 lb / 30 kg	0.002 lb / 1 g	0.02 lb / 10 g	8.9 in x 11.8 in / 225 mm x 300 mm	30031711

Accessories	Item No.
Ethernet Kit, R31 RC31 R71 V71 R41	30037447
RS232 Kit, R31 RC31 R71 V71 R41	30037448
USB Kit, R31 RC31 V71 R41	30037449
In-Use-Cover, R21 RC21 R31 RC31 R41	30037451

Accessories	Item No.
Printer, Impact, SF40A, AM	30064203
Printer, Thermal, STP-103, US (requires 80500525)	80251992
Cable, RS232, IBM 9P, AV DV MB Ranger	80500525
Carrying Case, TR TC R31 TC31 V71	80850084
Software, Winwedge	80850080

Compact Bench Scales

Valor® 7000

The Best Compact Food Scale in its Class

- Front and rear touchless sensors allow Valor 7000 to operate certain functions and its food-safe design is NSF Certified, USDA-AMS Accepted, and supports HACCP-Certified systems.
- Large front and rear displays with backlights and Checkweighing LEDs are among Valor 7000's features that enhance the user experience and allow two operators to share one scale.
- Valor 7000 produces accurate results within one second to virtually eliminate your wait time and allows you to move at a pace determined by you, not your weighing equipment.



- Application** Weighing, Percent Weighing, Checkweighing, Accumulation
- Display** Dual backlit liquid crystal displays (LCD)
- Operation** AC power (included) or rechargeable battery (included)
- Communication** RS232 (included) or second RS232 or USB or Ethernet (accessories sold separately)
- Construction** ABS housing, stainless steel platform, touchless sensor, transportation handle, menu lock switch, up front level indicator
- Design Features** 210 hours of battery life, 3 LED Checkweighing lights with selectable operation and audible signal settings, selectable environmental and auto-print settings, auto shut-off, auto tare, NTEP Certified and Measurement Canada Approved

Model	Capacity	Readability	Certified Readability	Platform Size	Item No.
V71P1502T	3 lb / 1.5 kg	0.0001 lb / 0.05 g	0.001 lb / 0.5 g	8.9 in x 11.8 in / 225 mm x 300 mm	30031827
V71P3T	6 lb / 3 kg	0.0002 lb / 0.1 g	0.002 lb / 1 g	8.9 in x 11.8 in / 225 mm x 300 mm	30031828
V71P6T	15 lb / 6 kg	0.0005 lb / 0.2 g	0.005 lb / 2 g	8.9 in x 11.8 in / 225 mm x 300 mm	30031829
V71P15T	30 lb / 15 kg	0.001 lb / 0.5 g	0.01 lb / 5 g	8.9 in x 11.8 in / 225 mm x 300 mm	30031830
V71P30T	60 lb / 30 kg	0.002 lb / 1 g	0.02 lb / 10 g	8.9 in x 11.8 in / 225 mm x 300 mm	30031831

Accessories	Item No.
In-Use-Cover, V71	30037445
Ethernet Kit, R31 RC31 R71 V71	30037447
RS232 Kit, R31 RC31 R71 V71	30037448
USB Kit, R31 RC31 V71	30037449
Hook, R21 RC21 R31 RC31 V71	30037450

Accessories	Item No.
In-Use-Cover, Set(10), V71	30037469
Printer, Impact, SF40A, AM	30064203
Cable, RS232, IBM 9P, AV DV MB Ranger	80500525
Carrying Case, TR TC R31 TC31 V71	80850084
Software, Winwedge	80850080

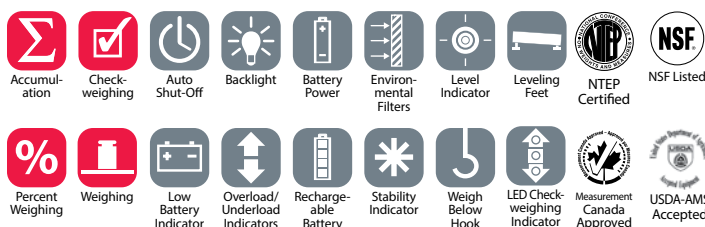

FD Series

Speed, Durability and Cleanliness Designed for Food Service Use



- The fully stainless steel FD is NSF Certified and supports HACCP-Certified systems helping to ensure the integrity and safety of the weighing of all food products.
- With software for general weighing, percent weighing and Checkweighing, the FD can be used for a variety of food weighing needs.
- The 120-hour internal rechargeable battery will help ensure that your scale is up and running when you need it, even during long shifts.

- Application** Weighing, Percent Weighing, Checkweighing
- Display** Backlit liquid crystal display (LCD)
- Operation** AC adapter (included) or rechargeable battery (included)
- Construction** Stainless steel housing and platform, up-front level indicator
- Design Features** Manual or automatic tare, audible buzzer alerts, LED Checkweighing lights, foot switch (optional), NTEP Certified and Measurement Canada Approved

Model	Capacity	Readability	Certified Readability	Platform Size	Item No.
FD3H	6 lb / 3 kg	0.0002 lb / 0.1 g	—	8.2 in x 8.2 in / 209 mm x 209 mm	83998147
FD6H	15 lb / 6 kg	0.001 lb / 0.2 g		8.2 in x 8.2 in / 209 mm x 209 mm	83998148
FD15H	30 lb / 15 kg	0.001 lb / 1 g		8.2 in x 8.2 in / 209 mm x 209 mm	83998149

Approved Model*	Capacity	Readability	Certified Readability	Platform Size	Item No.
FD3	6 lb / 3 kg	0.001 lb / 0.5 g	0.002 lb / 1 g	8.2 in x 8.2 in / 209 mm x 209 mm	83998117
FD6	15 lb / 6 kg	0.002 lb / 1 g	0.005 lb / 2 g	8.2 in x 8.2 in / 209 mm x 209 mm	83998118
FD15	30 lb / 15 kg	0.005 lb / 2 g	0.01 lb / 5 g	8.2 in x 8.2 in / 209 mm x 209 mm	83998119

Accessories	Item No.
In-Use-Cover, FD V51	80251140
Pan, SST, Flat, FD V51	80251141
Carrying Case, FD V51	80251394



Compact Bench Scales

Valor® 4000

Legal-for-Trade Food Scale That Enhances Efficiency in Harsh Environments

- With Legal-for-Trade certifications and a food-safe design that is NSF Certified, USDA-AMS Accepted and supports HACCP Certified systems, Valor 4000 is ready for demanding applications.
- Touchless sensors combined with a half second stabilization time, as well as Checkweighing and percent weighing modes, increase productivity without sacrificing accuracy.
- Safe to use in wet environments, Valor 4000's flow-thru design ensures the scale remains clean and operational, and its knife resistant keypad makes the scale more durable.

- Application** Weighing, Percent Weighing, Checkweighing, Accumulation
- Display** Dual light emitting diode (LED) displays
- Operation** AC adapter (included) or rechargeable battery (included)
- Construction** ABS housing with stainless steel platform (PW), stainless steel housing and platform (XW), illuminated up-front level indicator, rear touchless sensor
- Design Features** Auto-close power jack cover, menu and mode setup navigation prompts on keys, transportation handle, NTEP Certified and Measurement Canada Approved



XW Models Feature Stainless Steel Top Housing

Model	Protection Rating	Capacity	Readability	Certified Readability	Platform Size	Item No.
V41XWE1501T	IPX8	3 lb / 1.5 kg	0.0005 lb / 0.2 g	0.001 lb / 0.5 g	7.5 in x 9.5 in / 190 mm x 242 mm	30035444
V41XWE3T		6 lb / 3 kg	0.001 lb / 0.5 g	0.002 lb / 1 g	7.5 in x 9.5 in / 190 mm x 242 mm	30035445
V41XWE6T		15 lb / 6 kg	0.002 lb / 1 g	0.005 lb / 2 g	7.5 in x 9.5 in / 190 mm x 242 mm	30035446
V41XWE15T		30 lb / 15 kg	0.005 lb / 2 g	0.01 lb / 5 g	7.5 in x 9.5 in / 190 mm x 242 mm	30035447

PW Models Feature ABS Housing

Model	Protection Rating	Capacity	Readability	Certified Readability	Platform Size	Item No.
V41PWE1501T	IPX8	3 lb / 1.5 kg	0.0005 lb / 0.2 g	0.001 lb / 0.5 g	7.5 in x 9.5 in / 190 mm x 242 mm	30035434
V41PWE3T		6 lb / 3 kg	0.001 lb / 0.5 g	0.002 lb / 1 g	7.5 in x 9.5 in / 190 mm x 242 mm	30035435
V41PWE6T		15 lb / 6 kg	0.002 lb / 1 g	0.005 lb / 2 g	7.5 in x 9.5 in / 190 mm x 242 mm	30035436
V41PWE15T		30 lb / 15 kg	0.005 lb / 2 g	0.01 lb / 5 g	7.5 in x 9.5 in / 190 mm x 242 mm	30035437

Accessories	Item No.
Large Pan, 11.8 x 8.8 in V22 V41	30251753



Valor® 3000

Rugged, Full Stainless Steel Design in a High Performance Portable Scale

- The stainless steel Valor 3000 Xtreme is NSF Certified and supports HACCP-Certified systems helping to ensure the integrity and safety of all food products weighed on the scale.
- The compact Valor 3000 Xtreme requires minimal counter space and offers resolutions up to 40,000d and 0.01 g, providing precise measurements in demanding environments.
- With software for general weighing, percent weighing and specific gravity, the Valor 3000 can be used for a variety of food weighing and measurement needs.

- Application** Weighing, Percent Weighing, Specific Gravity
- Display** Backlit liquid crystal display (LCD)
- Operation** AC adapter (included) or 4 C (LR14) batteries (not included)
- Construction** Stainless steel housing and platform, up-front level indicator, load cell lock
- Design Features** Selectable environmental settings, auto tare, auto shut-off, selectable power-up unit, optional food accessories, NTEP Certified models available



Model	Protection Rating	Capacity	Readability	Certified Readability	Platform Size	Item No.
V31XH202	Not Applicable	0.441 lb / 200 g	0.00005 lb / 0.01 g	—	Ø 4.7 in / Ø 120 mm	83998130
V31XW301	IP65; NEMA 4X	0.662 lb / 300 g	0.0005 lb / 0.1 g		6.2 in x 5.7 in / 158 mm x 146 mm	83998134
V31XH402	Not Applicable	0.88 lb / 400 g	0.00005 lb / 0.01 g		Ø 4.7 in / Ø 120 mm	83998178
V31X501		1.1 lb / 500 g	0.0005 lb / 0.1 g		Ø 4.7 in / Ø 120 mm	83998176
V31XH2		4.4 lb / 2 kg			6.2 in x 5.7 in / 158 mm x 146 mm	83998131
V31X3		6 lb / 3 kg	0.005 lb / 1 g		6.2 in x 5.7 in / 158 mm x 146 mm	83998132
V31XH4		8.8 lb / 4 kg	0.0005 lb / 0.1 g		6.2 in x 5.7 in / 158 mm x 146 mm	83998177
V31X6		15 lb / 6 kg	0.005 lb / 1 g		6.2 in x 5.7 in / 158 mm x 146 mm	83998133

Approved Model*	Protection Rating	Capacity	Readability	Certified Readability	Platform Size	Item No.
V31XW3	IP65; NEMA 4X	6 lb / 3 kg	0.005 lb / 0.5 g	0.005 lb / 1 g	6.2 in x 5.7 in / 158 mm x 146 mm	83998135
V31X3N	Not Applicable				6.2 in x 5.7 in / 158 mm x 146 mm	83999992
V31X6N	IP65; NEMA 4X	13.23 lb / 6 kg	0.005 lb / 1 g	0.005 lb / 2 g	6.2 in x 5.7 in / 158 mm x 146 mm	83999996
V31XW6		15 lb / 6 kg			6.2 in x 5.7 in / 158 mm x 146 mm	83998136

Accessories	Item No.
Large Pan, SST, Sandwich, V31	80251147
Holder, SST, French Fries, V31	80251148
Holder, SST, Ice Cream Cone, V31	80251149
Carrying Case, V31	80251216



Compact Bench Scales

Valor® 2000

A Rapid-Response Food Scale That Enhances Productivity in Harsh Environments

- Valor 2000 has a polycarbonate keypad that can endure contact with knives or sharp instruments used daily in demanding food preparation, processing and portioning applications.
- Safe to use in the weighing of liquids and in wet environments, Valor 2000 is NSF Certified and has a flow-thru design that ensures the scale remains clean and operational.
- With less than half a second stabilization time and front and rear LED displays, multiple operators can efficiently utilize one scale for the same job.

- Application** Weighing, Checkweighing (XW only)
- Display** Dual light emitting diode (LED) displays
- Operation** AC adapter (included) or rechargeable battery (included)
- Construction** ABS housing with stainless steel platform (PW), stainless steel housing and platform (XW), up-front level indicator
- Design Features** Auto-close power jack cover, transportation handle



60 lb models available

XW Models Feature Stainless Steel Top Housing

Model	Protection Rating	Capacity	Readability	Platform Size	Item No.
V22XWE1501T	IPX8	3 lb / 1.5 kg	0.0005 lb / 0.2 g	7.5 in x 9.5 in / 190 mm x 242 mm	30035439
V22XWE3T		6 lb / 3 kg	0.001 lb / 0.5 g	7.5 in x 9.5 in / 190 mm x 242 mm	30035440
V22XWE6T		15 lb / 6 kg	0.002 lb / 1 g	7.5 in x 9.5 in / 190 mm x 242 mm	30035441
V22XWE15T		30 lb / 15 kg	0.005 lb / 2 g	7.5 in x 9.5 in / 190 mm x 242 mm	30035442
V22XWE30T		60 lb / 30 kg	0.01 lb / 5 g	7.5 in x 9.5 in / 190 mm x 242 mm	30251705

PW Models Feature ABS Housing

Model	Protection Rating	Capacity	Readability	Platform Size	Item No.
V22PWE1501T	IPX8	3 lb / 1.5 kg	0.0005 lb / 0.2 g	7.5 in x 9.5 in / 190 mm x 242 mm	30035682
V22PWE3T		6 lb / 3 kg	0.001 lb / 0.5 g	7.5 in x 9.5 in / 190 mm x 242 mm	30035683
V22PWE6T		15 lb / 6 kg	0.002 lb / 1 g	7.5 in x 9.5 in / 190 mm x 242 mm	30035684
V22PWE15T		30 lb / 15 kg	0.005 lb / 2 g	7.5 in x 9.5 in / 190 mm x 242 mm	30035685
V22PWE30T		60 lb / 30 kg	0.01 lb / 5 g	7.5 in x 9.5 in / 190 mm x 242 mm	30251704

Accessories	Item No.
Large Pan, 11.8 x 8.8 in V22 V41	30251753



Valor® 1000

Economical, Multipurpose Weighing

- Valor 1000 is NSF Certified and supports HACCP-Certified systems helping to ensure the integrity and safety of all food products weighed on the scale.
- With software for general weighing, Checkweighing, and accumulation, Valor 1000 can be used for a variety of food weighing and measurement needs.
- An 80-hour internal rechargeable battery provides portability and ensures the scale will be operational when you need it.



- Application** Weighing, Checkweighing, Accumulation
- Display** Backlit liquid crystal display (LCD)
- Operation** AC adapter (included) or rechargeable battery (included)
- Construction** ABS housing, stainless steel platform, up-front level indicator
- Design Features** External calibration software, selectable environmental settings, selectable weighing units

Model	Dual Display	Capacity	Readability	Platform Size	Item No.
V11P3		6.6 lb / 3 kg	0.001 lb / 0.5 g	9.9 in x 7.1 in / 250 mm x 180 mm	83998126
V11P3T	•			9.9 in x 7.1 in / 250 mm x 180 mm	83998172
V11P6		13 lb / 6 kg	0.002 lb / 1 g	9.9 in x 7.1 in / 250 mm x 180 mm	83998127
V11P6T	•			9.9 in x 7.1 in / 250 mm x 180 mm	83998173
V11P15		33 lb / 15 kg	0.005 lb / 2 g	9.9 in x 7.1 in / 250 mm x 180 mm	83998128
V11P15T	•			9.9 in x 7.1 in / 250 mm x 180 mm	83998174
V11P30		66 lb / 30 kg	0.01 lb / 5 g	9.9 in x 7.1 in / 250 mm x 180 mm	83998129
V11P30T	•			9.9 in x 7.1 in / 250 mm x 180 mm	83998175

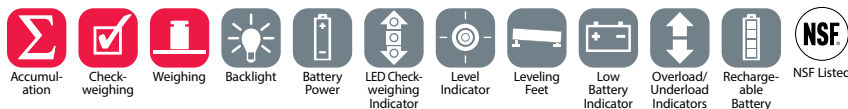

Catapult® 1000

Economical Compact Shipping Scales

- The sturdy ABS plastic housing and platform with optional stainless steel platform make Catapult sturdy yet easy to maneuver and fit into your workspace.
- Bring the Catapult 1000 right to your work with the integrated carrying handle and its battery powered operation.
- Catapult 1000 not only provides accurate general weight determination but also has the software to support dynamic/animal weighing and display hold.
- New WeighAlert mode in C11P75 model flashes weight display when weight on platform is greater than 70lb and less than 151lb, alerting user that package is too heavy for USPS service but below Less-Than-Truckload (LTL) limit for shipping.



WeighAlert mode available



- Application** Weighing, Animal/Dynamic Weighing, Display Hold
- Display** Liquid crystal display (LCD)
- Operation** AC adapter (included) or 3 C (LR14) batteries (not included)
- Construction** ABS housing and platform, stainless steel platform (accessory sold separately), transportation handle
- Design Features** Low profile, compact design

Model	Capacity	Readability	Platform Size	Item No.
C11P9	20 lb / 9 kg	0.01 lb / 0.005 kg	11 in x 12.4 in / 280 mm x 316 mm	83998137
C11P20	44 lb / 20 kg	0.02 lb / 0.01 kg	11 in x 12.4 in / 280 mm x 316 mm	83998138
C11P75	165 lb / 75 kg	0.1 lb / 0.05 kg	11 in x 12.4 in / 280 mm x 316 mm	83998139

Accessories	Item No.
Pan, SST, C11P	80251248

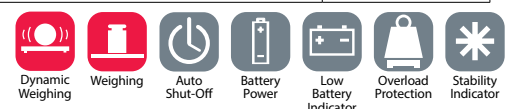

TD52

Multifunctional Indicators for Standard Industrial Applications

- Large transfective dot matrix display and SmarText 3.0 interface guides use with five soft keys. Full alphanumeric keypad and 6 control keys makes operation easy.
- Supports up to 50,000 SKU items in memory and 1,000 user profiles with the included MicroSD card.
- Powerful enough to drive 8 350 ohm loadcells. Combine quickly with new OHAUS Defender W and R bases using EasyConnect system.



TD52P



TD52XW

- Application** Parts Counting with APW optimization, Checkweighing or Checkcounting, Percent Weighing, and Dynamic Weighing or Display Hold
- Display** Dot matrix LCD with white LED backlight, 256 x 80 pixels
- Operation** 100-240 VAC / 50/60 Hz Universal Power Supply, Hardwired (TD52XW) or Line Cord (TD52P), Rechargeable Lithium battery (optional)
- Communication** Standard RS232, MicroSD Card included; Optional Ethernet, WiFi/Bluetooth, 2nd RS232/RS485/USB, Analog Output, or 2 In/4 Out Digital I/O.
- Construction** TD52XW: All stainless steel housing and bracket, TD52P: ABS plastic housing and powder-coated steel bracket
- Design Features** Configurable resolution 75,000d/10,000e NTEP Class III/IIIL certified and Measurement Canada Class III/IIILD approved, GMP/GLP output with time/date, Alibi or standard memory, multiple operating languages, EasyConnect connector allows fast set-up with compatible Defender bases.

NEW
Available Early/Mid
2019

Model	Protection Rating	Item No.
TD52P	Dry Use ABS Indicator	30424078
TD52XW	IP68 / NEMA 4X Stainless Steel Indicator	30424079

Accessories	Item No.
2nd RS232/RS485/USB, TD523	30424404
Cable, RS232, CKW TxxXW	80500552
Cable, RS232, IBM 9P, AV DV MB Ranger	80500525
Ethernet Kit, D522	30429666
Analog Output Kit, TD523	30424403
I/O with Relay (2 In/4 Out)	30097591
Light Tower, R-Y-G, IP65, 24VDC (requires 30097591)	30424021
WiFi/BT Dongle, OHAUS (Requires 30424406)	30412537
USB Host for Dongle, TD52	30424406
Battery Kit, Li-ion, TD52	30424405

Accessories	Item No.
In-use Cover Set, TD52P	30424022
In-use Cover Set, TD52XW	30424023
In-use Cover set (10), TD52P	30469948
In-use Cover set (10), TD52XW	30469949
LC Extension Cable, 9 meters, D521	30424409
M16 Gland with Ferrite, to TD52	30379716
Wall Mount Kit, SST, TD52XW	30424026
Wall Mount Kit, CS, TD52P	30424027
Printer SF40A	30064203
Printer, Thermal, STP-103, US (requires 80500525)	80251992
Cable, RS232, CKW TxxXW	80500552
Software, Winwedge	80850080

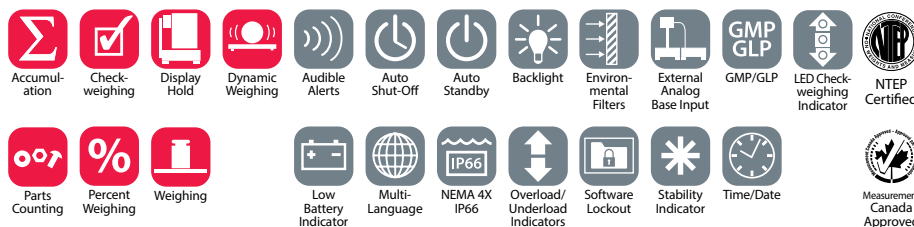

T72XW

Advanced Performance Stainless Steel Indicator with External Device Control Capabilities

- With a 50,000 displayed resolution and the ability to support up to 10 load cells, T72XW was designed for heavy-duty industrial applications.
- Two available option slots enable a wide range of connectivity interfaces. Control external devices using the discrete I/O interface and transfer data through the serial, USB or Ethernet ports.
- T72XW is very easy to set up and navigate, a vivid graphic display with on-screen prompts and an alphanumeric keypad with designated keys for common functions such as Tare and ID information.



With Truck In/Out Mode

- Application** Weighing, Parts Counting, Checkweighing, Animal / Dynamic Weighing , Totalization, Truck In/Out
- Display** Transflective graphic LCD with white backlight, 240 x 96 pixels
- Operation** AC Power (Included)
- Communication** RS232 and SD card reader with SD card included. Ethernet, USB/Discrete I/O or COM2 kit with 2nd RS232/485 available.
- Construction** IP66/NEMA 4X stainless steel housing and mounting bracket
- Design Features** User-configurable resolution 50,000d/10,000e, Checkweighing lights with selectable operation and audible signal settings, sealed front panel, five operating languages (English, Spanish, French, German and Italian), selectable environmental and auto-print settings, stability indicator, overload/underload indicators, NTEP Certified and Measurement Canada Approved

Model	Protection Rating	Item No.
T72XW	IP66; NEMA 4X	30126959

Accessories	Item No.
Printer, Impact, SF40A, AM	30064203
Printer, Thermal, STP-103, US (requires 80500525)	80251992
Ethernet Kit, T72XW	30132163
USB with I/O Kit, T72XW	30132164
COM2 Kit, T72XW	30132165
Column Adapter, SST, T32XW T51XW T71XW	72209340
Cable, RS232, CKW TxxXW	80500552
Cable ST103 - TxxXW	80252584
Software, Winwedge	80850080

T71XW

High Performance Stainless Steel Washdown Indicator for Advanced Applications

- T71XW can support advanced features such as accumulation mode, a 255-item library and optional alibi memory capability, and also has a 1:50,000 maximum displayed resolution.
- This advanced indicator has dual-scale capabilities in which it can display the weights from two platforms and is powerful enough to drive up to 8 - 350 ohm load cells per platform.
- With a full alphanumeric keypad and dual-line display, as well as SmarText™ software that utilizes text prompts to guide users through set up and use, T71XW is simple to operate.



For a Limited Time

- Application** Weighing, Parts Counting, Percent Weighing, Checkweighing, Dynamic/Animal Weighing, Accumulation, Display Hold
- Display** Backlit liquid crystal display (LCD) with secondary information line, 3 color Checkweighing LEDs
- Operation** Power cord (included) or rechargeable battery (accessory sold separately)
- Communication** RS232 (included). Internal 2nd RS232, RS232/RS485, AC or DC relay kits available. GLP/GMP data output with real-time clock.
- Construction** IP66/NEMA 4X stainless steel housing and mounting bracket
- Design Features** User-configurable resolution 50,000d/10,000e, Alibi memory kit (accessory sold separately), five operating languages, NTEP Certified and Measurement Canada Approved

Model	Protection Rating	Item No.
T71XW	IP66; NEMA 4X	83999839

Accessories	Item No.
Printer, Impact, SF40A, AM	30064203
Printer, Thermal, STP-103, US (requires 80500525)	80251992
PCBA Kit, Alibi Memory, R71 T71	80500503
Cable, RS232, CKW TxxXW	80500552
Relay Kit, AC, T51 T71	80500720
Relay Kit, DC, T51 T71	80500727
Rechargeable Battery Kit, T51 T71	80500729
RS422/485 Kit, T51 T71	80500731
RS232 Kit, T51 T71	80500733
Wall Mount Kit, SST, T51XW T71XW	80500735
Software, Winwedge	80850080
Column Kit, Painted, Floor Stand	30047153
Column Kit, Stainless Steel, Floor Stand	30047154
Cable ST103 - TxxXW	80252584

T71P

High Performance Indicator for Advanced Applications

- T71P can support advanced features such as accumulation mode, a 255-item library and optional alibi memory capability, and also has a 1:50,000 maximum displayed resolution.
- This advanced indicator has dual-scale capabilities in which it can display the weights from two platforms and is powerful enough to drive up to 8 - 350 ohm load cells per platform.
- With a full alphanumeric keypad and dual-line display, as well as SmarText™ software that utilizes text prompts to guide users through set up and use, T71P is simple to operate.



For a Limited Time

- Application** Weighing, Parts Counting, Percent Weighing, Checkweighing, Dynamic/Animal Weighing, Accumulation, Display Hold
- Display** Backlit liquid crystal display (LCD) with secondary information line, 3 color Checkweighing LEDs
- Operation** Power cord (included) or 6 C (LR14) batteries (not included) or rechargeable battery (accessory sold separately)
- Communication** RS232 (included). Internal 2nd RS232, RS232/RS485, AC or DC relay kits available. External RS232-USB or RS232-Ethernet connectors available. GLP/GMP data output with real-time clock.
- Construction** ABS housing and painted steel mounting bracket, non-slip rubber feet
- Design Features** User-configurable resolution 50,000d/10,000e, Alibi memory kit (accessory sold separately), five operating languages, NTEP Certified and Measurement Canada Approved

Model	Item No.
T71P	83998180

Accessories	Item No.
Printer, Impact, SF40A, AM	30064203
Wall Mount Kit, Painted, T51P T71P	72200227
Printer, Thermal, STP-103, US	80251992
PCBA Kit, Alibi Memory, R71 T71	80500503
Cable, RS232, IBM 9P, AV DV MB Ranger	80500525
Relay Kit, AC, T51 T71	80500720
Base Mount Kit, Painted, T51P T71P	80500722
Relay Kit, DC, T51 T71	80500727
Rechargeable Battery Kit, T51 T71	80500729
RS422/485 Kit, T51 T71	80500731
RS232 Kit, T51 T71	80500733
Software, Winwedge	80850080
Interface Kit, RS232-USB	30304101
Interface Kit, RS232-Ethernet	30304102

T51XW

Multifunctional Stainless Steel Washdown Indicator for Standard Industrial Applications



For a Limited Time

- T51XW features software for parts counting, dynamic weighing, percent weighing, Checkweighing, display hold for large containers and can meet traceability requirements.
- Multiple connectivity capabilities include built-in RS232 bi-directional interface and external input as well as optional RS422/485, second RS232 and AC or DC relay.
- The durably-built T51XW NEMA 4X/IP66 stainless steel water resistant indicator has a hinged front cover that opens easily for servicing and installation of the connectivity options.

- Application** Weighing, Parts Counting, Percent Weighing, Checkweighing, Dynamic/Animal Weighing, Display Hold
- Display** Backlit liquid crystal display (LCD), 3 color Checkweighing LEDs
- Operation** Power cord (included) or rechargeable battery (accessory sold separately)
- Communication** RS232 (included). Internal 2nd RS232, RS232/RS485, AC or DC relay kits available. GLP/GMP data output with real-time clock.
- Construction** IP66/NEMA 4X stainless steel housing and mounting bracket, four-key membrane keypad, easy-open hinged front cover
- Design Features** User-configurable resolution up to 30,000d/10,000e, NTEP Certified and Measurement Canada Approved

Model	Protection Rating	Item No.
T51XW	IP66; NEMA 4X	83999840

Accessories	Item No.
Printer, Impact, SF40A, AM	30064203
Printer, Thermal, STP-103, US (requires 80500525)	80251992
Cable, RS232, CKW TxxXW	80500552
Relay Kit, AC, T51 T71	80500720
Relay Kit, DC, T51 T71	80500727
Rechargeable Battery Kit, T51 T71	80500729
RS422/485 Kit, T51 T71	80500731
RS232 Kit, T51 T71	80500733
Wall Mount Kit, SST, T51XW T71XW	80500735
Cable Kit, Loadcell Adapter, T51 T71	80500736
Software, Winwedge	80850080
Column Kit, Painted, Floor Stand	30047153
Column Kit, Stainless Steel, Floor Stand	30047154
Cable ST103 - TxxXW	80252584

Checkweighing, Display Hold, Dynamic Weighing, G/N/T, Audible Alerts, Auto Shut-Off, Auto Standby, Backlight, Environmental Filters, GMP/GLP, LED Checkweighing Indicator, NTEP Certified, Parts Counting, Percent Weighing, Weighing, Low Battery Indicator, Overload/Underload Indicators, Software Lockout, Stability Indicator, Time/Date, NEMA 4X IP66, Measurement Canada Approved

T51P

Multifunctional ABS Plastic Indicator for Standard Industrial Applications

- T51P features software for parts counting, dynamic weighing, percent weighing, Checkweighing, display hold for large containers and can meet traceability requirements.
- Multiple connectivity capabilities include built-in RS232 bi-directional interface and external input as well as optional RS422/485, second RS232 and AC or DC relay.
- The durably-built ABS plastic housing T51P has a reversible rear cover that supplies multiple mounting options, including, wall, column, scale front, or table-top mounting.



For a Limited Time

- Application** Weighing, Parts Counting, Checkweighing, Dynamic/Animal Weighing, Display Hold, Percent Weighing
- Display** Backlit liquid crystal display (LCD), 3 color Checkweighing LEDs
- Operation** Power cord (included) or 6 C (LR14) batteries (not included) or rechargeable battery (accessory sold separately)
- Communication** RS232 (included). Internal 2nd RS232, RS232/RS485, AC or DC relay kits available. External RS232-USB or RS232-Ethernet connectors available. GLP/GMP data output with real-time clock.
- Construction** ABS housing and painted steel mounting bracket, four-key membrane keypad, reversible front cover, non-slip rubber feet
- Design Features** User-configurable resolution up to 30,000d/10,000e, NTEP Certified and Measurement Canada Approved

Model	Item No.
T51P	83998179

Accessories	Item No.
Printer, Impact, SF40A, AM	30064203
Printer, Thermal, STP-103, US (requires 80500525)	80251992
Cable, RS232, IBM 9P, AV DV MB Ranger	80500525
Cable, SF42-AV DV MB Ranger	80500571
Interface Kit, RS232-USB	30304101
Interface Kit, RS232-Ethernet	30304102
Relay Kit, AC, T51 T71	80500720
Base Mount Kit, Painted, T51P T71P	80500722
Relay Kit, DC, T51 T71	80500727
Rechargeable Battery Kit, T51 T71	80500729
RS422/485 Kit, T51 T71	80500731
RS232 Kit, T51 T71	80500733
Software, Winwedge	80850080
Column Kit, Painted, Floor Stand	30047153
Column Kit, Stainless Steel, Floor Stand	30047154

Checkweighing, Display Hold, Dynamic Weighing, Gross/Net/Tare, Audible Alerts, Auto Shut-Off, Auto Standby, Backlight, Battery Power, Environmental Filters, GMP/GLP, NTEP Certified, Parts Counting, Percent Weighing, Weighing, LED Checkweighing Indicator, Low Battery Indicator, Overload/Underload Indicators, Software Lockout, Stability Indicator, Time/Date, Measurement Canada Approved

T32XW

Economical Stainless Steel Washdown Indicator for Basic Industrial Applications



- The NEMA 4X/IP65 stainless steel construction protects the indicator from water damage and a hinged front cover opens up easily, offering instant access for servicing.
- The long-lasting internal rechargeable battery provides continuous operation for up to 58 hours, ensuring uninterrupted operation for more than two straight days.
- Simple operation enhanced by an easy-to-read display and even basic counting mode round out this industrial indicator, making it ideal for everyday basic industrial use.

- Application** Weighing, Parts Counting
- Display** Backlit liquid crystal display (LCD)
- Operation** Power cord (included) or rechargeable battery (included)
- Communication** Easy access communication port including RS232 interface (included)
- Construction** IP65/NEMA 4X stainless steel housing and mounting bracket, easy-open hinged front cover
- Design Features** User-configurable resolution up to 20,000d/6,000e, NTEP Certified and Measurement Canada Approved

Model	Protection Rating	Item No.
T32XW	IP65; NEMA 4X	83999823

Accessories	Item No.
Printer, Impact, SF40A, AM	30064203
Printer, Thermal, STP-103, US (requires 80500525)	80251992
Cable, RS232, CKW TxxXW	80500552
Software, Winwedge	80850080
Column Kit, Painted, Floor Stand	30047153
Column Kit, Stainless Steel, Floor Stand	30047154
Cable ST103 - TxxXW	80252584

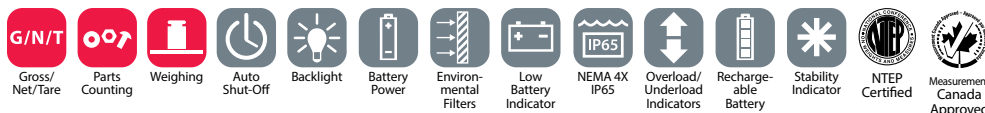

T32M

Economical Metal Indicator for Basic Industrial Applications

- T32MC and T32ME are OIML approved, NTEP certified, and Measurement Canada approved for use in all legal-for-trade applications.
- Application modes include weighing, simple parts counting, basic Checkweighing, display hold and accumulation of results.
- Constructed of painted steel housing and high-impact ABS faceplate, T32MC and T32ME are highly durable.

Application	Weighing, Parts Counting, Checkweighing, Accumulation, Display Hold
Display	T32MC: Backlit liquid crystal display (LCD) T32ME: Light-emitting diode display (LED)
Operation	AC adapter (included)
Communication	Easy access communication port including RS232 interface (included). External RS232-USB or RS232-Ethernet connectors available.
Construction	Front ABS/rear painted steel housing and painted steel mounting bracket
Design Features	User-configurable resolution up to 20,000d/6,000e, NTEP Certified and Measurement Canada Approved



Model	Item No.
T32ME	83998166
T32MC	83998167

Accessories	Item No.
Printer, Impact, SF40A, AM	30064203
Printer, Thermal, STP-103, US (requires 80500525)	80251992
Cable, RS232, IBM 9P, AV DV MB Ranger	80500525
Software, Winwedge	80850080
Column Kit, Painted, Floor Stand	30047153
Column Kit, Stainless Steel, Floor Stand	30047154
Interface Kit, RS232-USB	30304101
Interface Kit, RS232-Ethernet	30304102

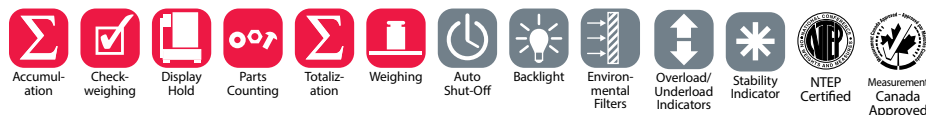

T31P

Economical ABS Plastic Indicator for Basic Industrial Applications

- T31P is OIML approved, NTEP certified and Measurement Canada approved for use in all legal-for-trade applications.
- The ultra-long-lasting internal rechargeable battery provides operation on a single charge for up to 120 hours.
- The reversible rear cover offers the flexibility for connected cables to exit above or below the indicator housing.

- Application** Weighing, Parts Counting
- Display** Backlit liquid crystal display (LCD)
- Operation** AC adapter (included) or rechargeable battery (included)
- Communication** Easy access communication port including RS232 interface (included). External RS232-USB or RS232-Ethernet connectors available.
- Construction** ABS housing and painted steel mounting bracket, non-slip rubber feet
- Design Features** User-configurable resolution up to 20,000d/6,000e, NTEP Certified and Measurement Canada Approved



Front mount handle accessory available

Model	Item No.
T31P	83998110

Accessories	Item No.
Printer, Impact, SF40A, AM	30064203
Printer, Thermal, STP-103, US (requires 80500525)	80251992
Cable, RS232, IBM 9P, AV DV MB Ranger	80500525
Software, Winwedge	80850080
Column Kit, Painted, Floor Stand	30047153
Column Kit, Stainless Steel, Floor Stand	30047154
Interface Kit, RS232-USB	30304101
Interface Kit, RS232-Ethernet	30304102
Handle Kit, D3K	30381321

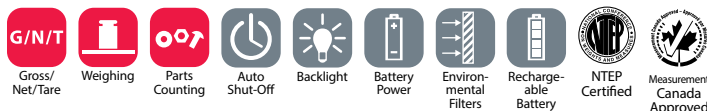

CKW Bases

High Quality Washdown Checkweighing Base



- The CKW base is NSF Certified, USDA-AMS Accepted, supports HACCP-certified systems, and is safe for use in food processing applications.
- Constructed with IP67 stainless steel, the CKW base is protected from harsh elements and can be thoroughly washed down to ensure cleanliness.
- The external level indicator and adjustable non-slip leveling feet assure that the base is stable and producing accurate results.

Construction 304 grade stainless steel platform with no visible threads, rounded corners, drain holes, extended skirt and open frame, IP67

Design Features No visible threads for conformance to food safety requirements, NSF Certified, USDA-AMS Accepted, and supports HACCP-certified systems with “NTEP Certified and Measurement Canada Approved

Model	Capacity	Readability	Certified Readability	Platform Size	Item No.
CKW3R	6 lb / 3 kg	0.001 lb / 0.5 g	0.002 lb / 1 g	10 in x 10 in / 254 mm x 254 mm	30379430
CKW6R	15 lb / 6 kg	0.002 lb / 1 g	0.005 lb / 2 g	10 in x 10 in / 254 mm x 254 mm	30379431
CKW15L	30 lb / 15 kg	0.005 lb / 2 g	0.01 lb / 5 g	12 in x 12 in / 305 mm x 305 mm	30379432
CKW30L	60 lb / 30 kg	0.01 lb / 5 g	0.02 lb / 10 g	12 in x 12 in / 305 mm x 305 mm	30379433



Defender WQ and WT Series Stainless Steel Bases

High Quality All Stainless Steel Base for Washdown Industrial Weighing



NEW
Available Early/Mid
2019

- Welded stainless steel construction in square and rectangular shapes for demanding industrial applications.
- Resolutions up to 25,000d/5,000e NTEP Class III and Measurement Canada Class III approved for legal-for-trade performance.
- Durably constructed with stainless steel platform, bases and loadcells.

Construction Stainless steel platform, base frame and loadcell.

Design Features Up to 25,000d/5,000e NTEP Class III certified and Measurement Canada Class III approved legal-for-trade performance, EasyConnect connector allows fast set-up with OHAUS TD52 indicators, speeding configuration and installation.

Model	Capacity	Readability	Certified Readability	Platform Size	Item No.
D2WQS	5 lb / 2.5 kg	0.0002 lb / 0.1g	0.001 lb / 0.5 g	10 x 10 in / 254 x 254 mm	30419628
D5WQS	10 lb / 5 kg	0.0005 lb / 0.2 g	0.002 lb / 1 g		30419629
D12WQS	25 lb / 12.5 kg	0.001 lb / 0.5 g	0.005 lb / 5 g		30419630
D12WQR				30419634	
D25WQR	50 lb / 25 kg	0.002 lb / 1 g	0.01 lb / 5 g	12 x 12 in / 305 x 305 mm	30419635
D50WQR	100 lb / 50 kg	0.005 lb / 2 g	0.02 lb / 10 g		30419636
D25WQL	50 lb / 25 kg	0.002 lb / 1 g	0.01 lb / 5 g		30419642
D50WQL	100 lb / 50 kg	0.005 lb / 2 g	0.02 lb / 10 g	18 x 18 in / 457 x 457 mm	30419643
D125WQL	250 lb / 125 kg	0.01 lb / 5 g	0.05 lb / 50 g		30419644
D50WTX	100 lb / 50 kg	0.005 lb / 2 g	0.02 lb / 10 g		30419648
D125WTX	250 lb / 125 kg	0.01 lb / 5 g	0.05 lb / 50 g	18 x 24 in / 457 x 610 mm	30419649
D250WTX	500 lb / 250 kg	0.02 lb / 10 g	0.1 lb / 50 g		30419650
D50WQV	100 lb / 50 kg	0.005 lb / 2 g	0.02 lb / 10 g	24 x 24 in / 610 x 610 mm	30419655
D125WQV	250 lb / 125 kg	0.01 lb / 5 g	0.05 lb / 50 g		30419656
D250WQV	500 lb / 250 kg	0.02 lb / 10 g	0.1 lb / 50 g		30419657
D500WQV*	1,000 lb / 500 kg	0.05 lb / 20 g	0.2 lb / 100 g		30419658

* Aluminum IP67 load cell



Defender RQ and RT Series Bases

High Quality Powder-Coated Steel Bases for Industrial Weighing

- Welded steel construction in square and rectangular shapes for demanding industrial applications.
- Resolutions up to 25,000d/5,000e NTEP Class III and Measurement Canada Class III approved for legal-for-trade performance.
- Durably constructed with stainless steel platform, powder-coated steel bases and aluminum loadcells.

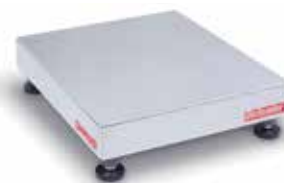

NEW
Available Early/Mid
2019

Construction Stainless steel platform, powder-coated base frame and aluminum loadcell.

Design Features Up to 25,000d/5,000e NTEP Class III certified and Measurement Canada Class III approved legal-for-trade performance, EasyConnect connector allows fast set-up with OHAUS TD52 indicators, speeding configuration and installation.

Model	Capacity	Readability	Certified Readability	Platform Size	Item No.
D12RQR	25 lb / 12.5 kg	0.001 lb / 0.5 g	0.005 lb / 2 g	12 x 12 in / 305 x 305 mm	30419631
D25RQR	50 lb / 25 kg	0.002 lb / 1 g	0.01 lb / 5 g		30419632
D50RQR	100 lb / 50 kg	0.005 lb / 2 g	0.02 lb / 10 g		30419633
D12RTR	25 lb / 12.5 kg	0.001 lb / 0.5 g	0.005 lb / 2 g	12 x 14 in / 305 x 355 mm	30419637
D25RTR	50 lb / 25 kg	0.002 lb / 1 g	0.01 lb / 5 g		30419638
D50RTR	100 lb / 50 kg	0.005 lb / 2 g	0.02 lb / 10 g		30419639
D50RQL	100 lb / 50 kg	0.005 lb / 2 g	0.02 lb / 10 g	18 x 18 in / 457 x 457 mm	30419640
D125RQL	250 lb / 125 kg	0.01 lb / 5 g	0.05 lb / 20 g		30419641
D50RTX	100 lb / 50 kg	0.005 lb / 2 g	0.02 lb / 10 g	18 x 24 in / 457 x 610 mm	30419645
D125RTX	250 lb / 125 kg	0.01 lb / 5 g	0.05 lb / 20 g		30419646
D250RTX	500 lb / 250 kg	0.02 lb / 10 g	0.1 lb / 50 g		30419647
D50RQV	100 lb / 50 kg	0.005 lb / 2 g	0.02 lb / 10 g	24 x 24 in / 610 x 610 mm	30419651
D125RQV	250 lb / 125 kg	0.01 lb / 5 g	0.05 lb / 20 g		30419652
D250RQV	500 lb / 250 kg	0.02 lb / 10 g	0.1 lb / 50 g		30419653
D500RQV	1,000 lb / 500 kg	0.05 lb / 20 g	0.2 lb / 100 g		30419654
D125RTV	250 lb / 125 kg	0.01 lb / 5 g	0.05 lb / 20 g		30419659
D250RTV	500 lb / 250 kg	0.02 lb / 10 g	0.1 lb / 50 g	23.6 x 31.5 in / 600 x 800 mm	30419660
D500RTV	1,000 lb / 500 kg	0.05 lb / 20 g	0.2 lb / 100 g		30419661



Defender® W Series Stainless Steel Bases

Top Quality Base for Washdown Industrial Weighing

- The stainless steel form-and-weld frame and stainless steel platform provide ample support for industrial weighing applications.
- Marked by durability, rigidity and structural integrity, Defender W Series bases are constructed to perform highly in industrial environments.
- Defender W Series bases have resolutions of up to 15,000d to meet the needs of industrial weighing applications that require extreme accuracy.



For a Limited Time

Construction 304 grade stainless steel platform, stainless steel form-and-weld frame, IP67 stainless steel load cell, level indicator

Design Features NTEP Certified and Measurement Canada Approved, Wheel kits (optional)

Model	Capacity	Readability	Certified Readability	Platform Size	Item No.
D10WR	25 lb / 10 kg	0.002 lb / 1 g	0.005 lb / 2 g	12 in x 12 in / 305 mm x 305 mm	80251925
D25WR	50 lb / 25 kg	0.005 lb / 2 g	0.01 lb / 5 g	12 in x 12 in / 305 mm x 305 mm	80251926
D50WL	100 lb / 50 kg	0.01 lb / 5 g	0.02 lb / 10 g	18 in x 18 in / 457 mm x 457 mm	80251927
D100WL	250 lb / 100 kg	0.02 lb / 10 g	0.05 lb / 20 g	18 in x 18 in / 457 mm x 457 mm	80251928
D250WX	500 lb / 250 kg	0.05 lb / 20 g	0.1 lb / 50 g	24 in x 24 in / 610 mm x 610 mm	80251929



Defender® H Series Bases

High Quality Bases For Industrial Environments

- The black polyurethane painted steel form-and-weld frame and stainless steel platform provides ample support for industrial weighing applications.
- Marked by durability, rigidity and structural integrity, Defender H Series bases are constructed to perform highly in industrial environments.
- Defender H Series bases are high resolution and can meet the needs of industrial weighing applications that require extreme accuracy.



For a Limited Time

Construction 304 grade stainless steel platform, black polyurethane painted steel form-and-weld frame, IP67 aluminum load cell, level indicator

Design Features 150% capacity overload protection, NTEP Certified and Measurement Canada Approved, Wheel kits (optional)

Model	Capacity	Readability	Certified Readability	Platform Size	Item No.
D15HR	30 lb / 15 kg	0.002 lb / 1 g	0.01 lb / 5 g	14 in x 12 in / 355 mm x 305 mm	30379448
D30HR	60 lb / 30 kg	0.005 lb / 2 g	0.02 lb / 10 g	14 in x 12 in / 355 mm x 305 mm	30379449
D60HR	150 lb / 60 kg	0.01 lb / 5 g	0.05 lb / 20 g	14 in x 12 in / 355 mm x 305 mm	30379450
D60HL				16 in x 20 in / 400 mm x 500 mm	30379451
D100HL	250 lb / 100 kg	0.02 lb / 10 g	0.1 lb / 50 g	16 in x 20 in / 400 mm x 500 mm	30379452
D150HX	300 lb / 150 kg			22 in x 17 in / 550 mm x 420 mm	30379453
D300HX	600 lb / 300 kg	0.05 lb / 50 g	0.2 lb / 100 g	22 in x 17 in / 550 mm x 420 mm	30379454



Defender® Q Series Bases

Top Quality Base for Industrial Weighing

- A black polyurethane painted steel form-and-weld frame with stainless steel platform provides ample support for industrial weighing applications.
- Marked by durability, rigidity and structural integrity, Defender Q Series bases are constructed to perform highly in industrial environments.
- Defender Q Series bases have resolutions of up to 15,000d to meet the needs of industrial weighing applications that require extreme accuracy.



For a Limited Time

Construction 304 grade stainless steel platform, painted carbon steel form-and-weld frame, IP67 aluminum load cell, level indicator

Design Features 150% capacity overload protection, NTEP Certified and Measurement Canada Approved, Wheel kits (optional)

Model	Protection Rating	Capacity	Readability	Certified Readability	Platform Size	Item No.
D10QR	IP67	25 lb / 10 kg	0.002 lb / 1 g	0.005 lb / 2 g	12 in x 12 in / 305 mm x 305 mm	80251920
D25QR		50 lb / 25 kg	0.005 lb / 2 g	0.01 lb / 5 g	12 in x 12 in / 305 mm x 305 mm	80251921
D50QL		100 lb / 50 kg	0.01 lb / 5 g	0.02 lb / 10 g	18 in x 18 in / 457 mm x 457 mm	80251922
D100QL		250 lb / 100 kg	0.02 lb / 10 g	0.05 lb / 20 g	18 in x 18 in / 457 mm x 457 mm	80251923
D250QX		500 lb / 250 kg	0.05 lb / 20 g	0.1 lb / 50 g	24 in x 24 in / 610 mm x 610 mm	80251924



Defender® V Series Stainless Steel Bases

Economical Base for Washdown Industrial Weighing

- The sturdy tubular 304 stainless steel platform provides ample support for industrial weighing applications.
- The IP67 load cells ensure accurate and repeatable results.
- The non-slip adjustable rubber leveling feet provide stability during the weighing process.



30 lb model available

Construction 304 grade stainless steel platform, stainless steel tubular frame, IP67 stainless steel load cell, level indicator

Design Features 125% capacity overload protection, NTEP Certified and Measurement Canada Approved, Wheel kits (optional)

Model	Capacity	Readability	Certified Readability	Platform Size	Item No.
D15VR	30 lb / 15 kg	0.005 lb / 2g	0.01 lb / 5 g	14 in x 12 in / 355 mm x 305 mm	30379441
D30VR	60 lb / 30 kg	0.01 lb / 5 g	0.02 lb / 10 g	14 in x 12 in / 355 mm x 305 mm	30379442
D60VR	150 lb / 60 kg	0.02 lb / 10 g	0.05 lb / 20 g	14 in x 12 in / 355 mm x 305 mm	30379443
D60VL				21.7 in x 16.5 in / 550 mm x 420 mm	30379444
D150VL	300 lb / 150 kg	0.05 lb / 20 g	0.1 lb / 50 g	21.7 in x 16.5 in / 550 mm x 420 mm	30379445
D150VX				25.6 in x 19.7 in / 650 mm x 500 mm	30379446
D300VX				25.6 in x 19.7 in / 650 mm x 500 mm	30379447



Defender® B Series Bases

Economical Base for Industrial Weighing

- The sturdy tubular 304 stainless steel platform provides ample support for industrial weighing applications.
- The IP67 load cells ensure accurate and repeatable results.
- The non-slip adjustable rubber leveling feet provide stability during the weighing process.



30 lb model available

Construction 304 grade stainless steel platform, black painted steel tubular frame, IP67 aluminum load cell, level indicator

Design Features 125% capacity overload protection, NTEP Certified and Measurement Canada Approved, Wheel kits (optional)

Model	Capacity	Readability	Certified Readability	Platform Size	Item No.
D15BR	30lb / 15kg	0.005 lb / 2g	0.01 lb / 5 g	14 in x 12 in / 355 mm x 305 mm	30379434
D30BR	60 lb / 30 kg	0.01 lb / 5 g	0.02 lb / 10 g	14 in x 12 in / 355 mm x 305 mm	30379435
D60BR	150 lb / 60 kg	0.02 lb / 10 g	0.05 lb / 20 g	14 in x 12 in / 355 mm x 305 mm	30379436
D60BL				21.7 in x 16.5 in / 550 mm x 420 mm	30379437
D150BL	300 lb / 150 kg	0.05 lb / 20 g	0.1 lb / 50 g	21.7 in x 16.5 in / 550 mm x 420 mm	30379438
D150BX				25.6 in x 19.7 in / 650 mm x 500 mm	30379439
D300BX	600 lb / 300 kg	0.1 lb / 50 g	0.2 lb / 100 g	25.6 in x 19.7 in / 650 mm x 500 mm	30379440



Aviator 7000*

Versatile Counter Top Price Computing Scale for Retail Business

- Quick-response light-touch keyboard with exchangeable preset card and keysheet layers.
- Standard alkaline D-cell or rechargeable NiMH batteries plus integrated carry handles for portability.
- Multiple connection possibilities - RS232 or USB to POS, RS232 to external printer.

- Application** Weighing, Price Computing
- Display** 4-line backlit LCD including 6-digit weight, 6-digit unit price, 7-digit total price and 4-digit preset tare line
- Operation** AC Adapter (Included) or 6 Alkaline (Not included) or 6 NiMH Rechargeable D- cell Batteries (available as an Accessory)
- Communication** RS232 (Available as an Accessory), USB (as an accessory)
- Construction** ABS housing with stainless steel platform
- Design Features** 100 PLU and 24 preset keys plus exchangeable preset card and keysheet layers, adjustable rubber non-slip feet & front level bubble, integrated adapter storage and carry handles, NTEP Certified



Model	Capacity	Readability	Certified Readability	Platform Size	Item No.
A71P15DNUS	15 lb; 30 lb /	0.005 lb; 0.01 lb /	0.005 lb; 0.01 lb /	9.5 in x 13.3 in / 240 mm x 337 mm	72248760
A71P15DTNUS	6 kg; 15 kg	2 g; 5 g	2 g; 5 g		72248762
A71P30DNUS	30 lb; 60 lb /	0.01 lb; 0.02 lb /	0.01 lb; 0.02 lb /		72248761
A71P30DTNUS	15 kg; 30 kg	5 g; 10 g	5 g; 10 g		72248763

Accessories	Item No.
Printer, Impact, SF40A, AM	30064203
Rechargeable Battery, x6, NiMH, bRite A71	72151831
SP, Keypad, Silicone, bRite A71	72231249
Keypad White Silicone Pad bRite A71	72231250
Cable, RJ45-RS232, POS, bRite A71	72237981
Cable, RJ45-USB, POS, bRite A71	72237984
Function Keyboard NA 100g OHAUS bLite	72241852

Accessories	Item No.
In-Use-Cover, bRite A51 A71	72247038
In-Use-Cover, Pan, bRite A51 A71	72247039
Pan, Rectangle, Deep, bRite A51 A71	72247115
Cable, RJ45-RS232, Printer, bRite A71	72249531
Thermal Printer Head Assy bRite A71 AM	72253293
Paper Roll, (1), Printer, bRite A71	72255953
Printer, Thermal, STP-103, US (requires 80500525)	80251992

* Available exclusively in U.S.



Calibration Weights



OHAUS' portfolio now includes the Troemner library of weights, backed by exclusive construction and more than 100 years of expertise. With a wide selection of weight classes backed by both ASTM and OIML, OHAUS weights offer a comprehensive range of 1 mg to 2000kg, and are available with certifications.



Weights & Weight Sets Overview



Our weights and weight sets are backed by the world's leading supplier of precision weights and mass standards. Since 1838, Troemner has enhanced its reputation as being the premier precision weight company by having industry recognized metrologists and highly trained calibrators on staff. Troemner's production of precision weights involves using the finest materials and equipment available in a state-of-the-art facility. For these important reasons, Troemner is capable of providing unmatched measurements and metrological analysis, to provide our customers with the precision weights they need.

Only the finest raw materials are selected in order to manufacture high quality weights. Troemner is the only supplier that has a special stainless steel blend called Troemner Alloy 8, which possesses closely controlled density (8.03 g/cm³), extremely low magnetic properties, good stability and resistance to corrosion.

Weight Selector Guide

Troemner UltraClass - For analytical and microbalances with readability as low as 1 g. These are the most precise two-piece weights available, with weight tolerances 40 to 50% better than ANSI/ASTM Class 1. Ultra Class weights combine high precision with the advantage of two-piece construction (1 g and larger) to avoid costly issues associated with one-piece weights.

ANSI/ASTM Class 1 - Can be used as a reference standard in calibrating other weights and is appropriate for calibrating high-precision analytical balances with a readability as low as 0.1 mg to 0.01 mg.

ANSI/ASTM Class 4 - For calibration of semi-analytical balances and for student use.

ANSI/ASTM Class 6 - This class meets the specifications of OIML R 111 Class M2.

OIML Class E1 - Used as a primary reference for calibrating other reference standards and weights where the stability of the environment and careful handling are assured. Class E1 weights have no method of adjustment and are not suitable for general laboratory use. The uncertainty is guaranteed to be 1/3 the tolerance.

OIML Class E2 - Can be used as a reference standard in calibrating other weights and is appropriate for calibrating high-precision analytical balances with a readability as low as 0.1 mg to 0.01 mg.

OIML Class F1 - Appropriate for calibrating high-precision top loading balances with a readability as low as 0.01 g to 0.001 g.

OIML Class F2 - For calibration of semi-analytical balances and for student use.

NIST Class F - Primarily used to test commercial weighing devices by state and local weights and measures officials, device installers, and service technicians.

Troemner UltraClass Individual Weights

Weight tolerance is equal to ANSI/ASTM E617 Class 0

- UltraClass weights combine high precision with the advantage of two-piece construction (1 g and larger) avoiding costly replacement issues associated with one-piece weights.
- Weights are designed so the specifications on surface finish, markings, construction, material density, and magnetic properties become more restrictive as the weight tolerances decrease.
- Individual weights 1 mg through 10 kg are supplied in durable polycarbonate cases. Case lids lock tightly to ensure that your weight is held securely and kept clean and dust free.



Without Certificate	
Model	Item No.
50 kg	30390204
30 kg	30390203
25 kg	30390202
20 kg	30390201
10 kg	30390200
5 kg	30390199
3 kg	30390198
2 kg	30390197
1 kg	30390196
500 g	30390195
300 g	30390194
200 g	30390193
100 g	30390192
50 g	30390191
30 g	30390190
20 g	30390189
10 g	30390188
5 g	30390187
3 g	30390186
2 g	30390185
1 g	30390184
500 mg	30390183
300 mg	30390182
200 mg	30390181
100 mg	30390180
50 mg	30390179
30 mg	30390178
20 mg	30390177
10 mg	30390176
5 mg	30390175
3 mg	30390174
2 mg	30390173
1 mg	30390172

Traceable Certificate	
Model	Item No.
50 kg	30390236
30 kg	30390235
25 kg	30390234
20 kg	30390233
10 kg	30390232
5 kg	30390231
3 kg	30390230
2 kg	30390229
1 kg	30390228
500 g	30390227
300 g	30390226
200 g	30390225
100 g	30390224
50 g	30390223
30 g	30390222
20 g	30390221
10 g	30390220
5 g	30390219
3 g	30390218
2 g	30390217
1 g	30390216
500 mg	30390215
300 mg	30390214
200 mg	30390213
100 mg	30390212
50 mg	30390211
30 mg	30390210
20 mg	30390209
10 mg	30390208
5 mg	30390207
3 mg	30390206
2 mg	30390205
1 mg	30390204

NVLAP Certificate	
Model	Item No.
50 kg	30390269
30 kg	30390268
25 kg	30390267
20 kg	30390266
10 kg	30390265
5 kg	30390264
3 kg	30390263
2 kg	30390262
1 kg	30390261
500 g	30390260
300 g	30390259
200 g	30390258
100 g	30390257
50 g	30390256
30 g	30390255
20 g	30390254
10 g	30390253
5 g	30390252
3 g	30390251
2 g	30390250
1 g	30390249
500 mg	30390248
300 mg	30390247
200 mg	30390246
100 mg	30390245
50 mg	30390244
30 mg	30390243
20 mg	30390242
10 mg	30390241
5 mg	30390240
3 mg	30390239
2 mg	30390238
1 mg	30390237

ASTM Class 1 Individual Weights

Adjusted to meet ASTM Class 1 Tolerances

- Can be used as a reference standard in calibrating other weights and is appropriate for calibrating high-precision analytical balances with a readability as low as 0.1 mg to 0.01 mg.
- Weights are designed so the specifications on surface finish, markings, construction, material density, and magnetic properties become more restrictive as the weight tolerances decrease.
- Individual weights 1 mg through 10 kg are supplied in durable polycarbonate cases. Case lids lock tightly to ensure that your weight is held securely and kept clean and dust free.



Without Certificate	
Model	Item No.
50 kg	30391425
30 kg	30391424
25 kg	30391423
20 kg	30391422
10 kg	30391421
5 kg	30391420
3 kg	30391419
2 kg	30391418
1 kg	30391417
500 g	30391416
300 g	30391415
200 g	80781143
100 g	80781141
50 g	80781139
30 g	30391411
20 g	80781135
10 g	80781133
5 g	80781131
3 g	30391407
2 g	80781127
1 g	80781125
500 mg	80781123
300 mg	30391403
200 mg	80781119
100 mg	80781117
50 mg	80781115
30 mg	30391399
20 mg	80781111
10 mg	80781109
5 mg	80781107
3 mg	30391395
2 mg	80781103
1 mg	80781101

Traceable Certificate	
Model	Item No.
50 kg	30391607
30 kg	30391606
25 kg	30391605
20 kg	30391604
10 kg	30391603
5 kg	30391602
3 kg	30391601
2 kg	30391600
1 kg	30391599
500 g	30391598
300 g	30391597
200 g	30391596
100 g	30391595
50 g	30391594
30 g	30391593
20 g	30391592
10 g	30391591
5 g	30391590
3 g	30391589
2 g	30391588
1 g	30391587
500 mg	30391586
300 mg	30391585
200 mg	30391584
100 mg	30391583
50 mg	30391582
30 mg	30391581
20 mg	30391580
10 mg	30391579
5 mg	30391578
3 mg	30391577
2 mg	30391576
1 mg	30391575

NVLAP Certificate	
Model	Item No.
50 kg	30391458
30 kg	30391457
25 kg	30391456
20 kg	30391455
10 kg	30391454
5 kg	30391453
3 kg	30391452
2 kg	30391451
1 kg	30391450
500 g	30391449
300 g	30391448
200 g	80781144
100 g	80781142
50 g	80781140
30 g	30391444
20 g	80781136
10 g	80781134
5 g	80781132
3 g	30391440
2 g	80781128
1 g	80781126
500 mg	80781124
300 mg	30391436
200 mg	80781120
100 mg	80781118
50 mg	80781116
30 mg	30391432
20 mg	80781112
10 mg	80781110
5 mg	80781108
3 mg	30391428
2 mg	80781104
1 mg	80781102

ASTM Class 4 Individual Weights

Adjusted to meet ASTM Class 4 Tolerances

- Can be used for calibration of semi-analytical balances and for student use.
- Weights are designed so the specifications on surface finish, markings, construction, material density, and magnetic properties become more restrictive as the weight tolerances decrease.
- Individual weights 1 mg through 10 kg are supplied in durable polycarbonate cases. Case lids lock tightly to ensure that your weight is held securely and kept clean and dust free.



Without Certificate	
Model	Item No.
50 kg	30391295
30 kg	30391294
25 kg	30391293
20 kg	30391292
10 kg	30391291
5 kg	30391290
3 kg	30391289
2 kg	30391288
1 kg	30391287
500 g	30391286
300 g	30391285
200 g	30391284
100 g	80780063
50 g	80780075
30 g	30391281
20 g	80780068
10 g	80780062
5 g	80780074
3 g	30391277
2 g	80780067
1 g	80780061
500 mg	80780073
300 mg	30391273
200 mg	80780066
100 mg	80780060
50 mg	80780072
30 mg	30391269
20 mg	80780065
10 mg	80780059
5 mg	80780071
3 mg	30391265
2 mg	80780064
1 mg	80780058

Traceable Certificate	
Model	Item No.
50 kg	30391108
30 kg	30391107
25 kg	30391106
20 kg	30391105
10 kg	30391104
5 kg	30391103
3 kg	30391102
2 kg	30391101
1 kg	30391100
500 g	30391099
300 g	30391098
200 g	30391097
100 g	30391096
50 g	30391095
30 g	30391094
20 g	30391093
10 g	30391092
5 g	30391091
3 g	30391090
2 g	30391089
1 g	30391088
500 mg	30391087
300 mg	30391086
200 mg	30391085
100 mg	30391084
50 mg	30391083
30 mg	30391082
20 mg	30391081
10 mg	30391080
5 mg	30391079
3 mg	30391078
2 mg	30391077
1 mg	30391076

NVLAP Certificate	
Model	Item No.
50 kg	30391328
30 kg	30391327
25 kg	30391326
20 kg	30391325
10 kg	30391324
5 kg	30391323
3 kg	30391322
2 kg	30391321
1 kg	30391320
500 g	30391319
300 g	30391318
200 g	30391317
100 g	80850287
50 g	80850297
30 g	30391314
20 g	80850292
10 g	80850286
5 g	80850296
3 g	30391310
2 g	80850291
1 g	80850285
500 mg	80850295
300 mg	30391306
200 mg	80850290
100 mg	80850284
50 mg	80850294
30 mg	30391302
20 mg	80850289
10 mg	80850283
5 mg	80850293
3 mg	30391298
2 mg	80850288
1 mg	80850282

Cal-Paks

Designed for Routine Maintenance of Your Balance

- The three weights included in the set will test the accuracy and linearity of your balance throughout its entire range.
- Cal-Pak components and carrying case are linked through the use of a unique serial number. You can trace your individual weights to the appropriate NVLAP Certificate and master carrying case.
- Cal-Paks are supplied in a case with accessories for care and handling of the weights including gloves and forceps.



Model	Item No.
2 G-1 MG CAL-PAK ULTRAClass W/ NVLAP	30391799
5 G-1 MG CAL-PAK ULTRAClass W/ NVLAP	30391798
20 G-20 MG CAL-PAK CL 1 W/ NVLAP	30391797
20 G-200 MG CAL-PAK CL 1 W/ NVLAP	30391796
50 G-200 MG CAL-PAK CL 1 W/ NVLAP	30390007
50 G-2 G CAL-PAK CL 1 W/ NVLAP	30391795
100 G-20 MG CAL-PAK CL 1 W/NVLAP	30391794
100 G-200 MG CAL-PAK CL 1 W/NVLAP	30391793
100 G-2 G CAL-PAK CL 1 W/NVLAP	30391792
200 G-200 MG CAL-PAK CL 1 W/NVLAP	30391791
200 G-2 G CAL-PAK CL 1 W/NVLAP	30391790
500 G-20 MG CAL-PAK CL 1 W/NVLAP	30391789
500 G-200 MG CAL-PAK CL 1 W/NVLAP	30391788
500 G-2 G CAL-PAK CL 1 W/NVLAP	30391787
1 KG-2 G CAL-PAK CL 1 W/NVLAP	30391786
1 KG-20 G CAL-PAK CL 1 W/NVLAP	30391785
2 KG-2 G CAL-PAK CL 1 W/NVLAP	30391784
2 KG-20 G CAL-PAK CL 1 W/NVLAP	30391783
5 KG-2 G CAL-PAK CL 1 W/NVLAP	30390006
5 KG-2 G CAL-PAK CLASS 1 W/NVLAP	30390005
5 KG-20 G CAL-PAK CL 1 W/NVLAP	30391782
5 KG-20 G CAL-PAK CLASS 1 W/NVLAP	30390004
5 KG-2 G CAL-PAK CL 1 W/NVLAP	30390003
5 KG-2 G CAL-PAK CLASS 1 W/NVLAP	30390002
5 KG-20 G CAL-PAK CL 1 W/NVLAP	30390001
5 KG-20 G CAL-PAK CLASS 1 W/NVLAP	30390000

Troemner UltraClass Weight Sets

Weight tolerance is equal to ANSI/ASTM E617 Class 0

- UltraClass weights combine high precision with the advantage of two-piece construction (1 g and larger) avoiding costly replacement issues associated with one-piece weights.
- Weights are designed so the specifications on surface finish, markings, construction, material density, and magnetic properties become more restrictive as the weight tolerances decrease.
- Weight sets 500 g and below include a polycarbonate case. Weight sets where the largest weight is 1 kg and above are supplied in a tough, lightweight, rugged case, designed to protect your weight set under any shipping circumstance.



Without Certificate	
Model	Item No.
50 kg-1 g	30390097
50 kg-1 mg	30390096
30 kg-1 g	30390095
30 kg-1 mg	30390094
25 kg-1 g	30390093
25 kg-1 mg	30390092
20 kg-1 g	30390091
20 kg-1 mg	30390090
10 kg-1 g	30390089
10 kg-1 mg	30390088
5 kg-1 g	30390087
5 kg-1 mg	30390086
2 - 2 kg-1 g	30390011
2 - 2 kg-1 mg	30390010
2 kg-1 g	30390085
2 kg-1 mg	30390084
1 kg-1 g	30390083
1 kg-1 mg	30390082
500 g-1 g	30390081
500 g-1 mg	30390080
2 - 200 g-1 g	30390009
2 - 200 g-1 mg	30390008
200 g-1 g	30390079
200 g-1 mg	30390078
100 g-1 g	30390077
100 g-100 mg	30390076
100 g-10 mg	30390075
100 g-5 mg	30390074
100 g-1 mg	30390073
50 g-1 g	30390072
50 g-100 mg	30390071
50 g-10 mg	30390070
50 g- 5 mg	30390069
50 g-1 mg	30390068
20 g-1 g	30390067
20 g-100 mg	30390066
20 g-10 mg	30390065
20 g-5 mg	30390064
20 g-1 mg	30390063
500 mg-10 mg	30390062
500 mg-1 mg	30390061

Traceable Certificate	
Model	Item No.
50 kg-1 g	30390134
50 kg-1 mg	30390133
30 kg-1 g	30390132
30 kg-1 mg	30390131
25 kg-1 g	30390130
25 kg-1 mg	30390129
20 kg-1 g	30390128
20 kg-1 mg	30390127
10 kg-1 g	30390126
10 kg-1 mg	30390125
5 kg-1 g	30390124
5 kg-1 mg	30390123
2 - 2 kg-1 g	30390015
2 - 2 kg-1 mg	30390014
2 kg-1 g	30390122
2 kg-1 mg	30390121
1 kg-1 g	30390120
1 kg-1 mg	30390119
500 g-1 g	30390118
500 g-1 mg	30390117
2 - 200 g-1 g	30390013
2 - 200 g-1 mg	30390012
200 g-1 g	30390116
200 g-1 mg	30390115
100 g-1 g	30390114
100 g-100 mg	30390113
100 g-10 mg	30390112
100 g-5 mg	30390111
100 g-1 mg	30390110
50 g-1 g	30390109
50 g-100 mg	30390108
50 g-10 mg	30390107
50 g- 5 mg	30390106
50 g-1 mg	30390105
20 g-1 g	30390104
20 g-100 mg	30390103
20 g-10 mg	30390102
20 g-5 mg	30390101
20 g-1 mg	30390100
500 mg-10 mg	30390099
500 mg-1 mg	30390098

NVLAP Certificate	
Model	Item No.
50 kg-1 g	30390171
50 kg-1 mg	30390170
30 kg-1 g	30390169
30 kg-1 mg	30390168
25 kg-1 g	30390167
25 kg-1 mg	30390166
20 kg-1 g	30390165
20 kg-1 mg	30390164
10 kg-1 g	30390163
10 kg-1 mg	30390162
5 kg-1 g	30390161
5 kg-1 mg	30390160
2 - 2 kg-1 g	30390019
2 - 2 kg-1 mg	30390018
2 kg-1 g	30390159
2 kg-1 mg	30390158
1 kg-1 g	30390157
1 kg-1 mg	30390156
500 g-1 g	30390155
500 g-1 mg	30390154
2 - 200 g-1 g	30390017
2 - 200 g-1 mg	30390016
200 g-1 g	30390153
200 g-1 mg	30390152
100 g-1 g	30390151
100 g-100 mg	30390150
100 g-10 mg	30390149
100 g-5 mg	30390148
100 g-1 mg	30390147
50 g-1 g	30390146
50 g-100 mg	30390145
50 g-10 mg	30390144
50 g- 5 mg	30390143
50 g-1 mg	30390142
20 g-1 g	30390141
20 g-100 mg	30390140
20 g-10 mg	30390139
20 g-5 mg	30390138
20 g-1 mg	30390137
500 mg-10 mg	30390136
500 mg-1 mg	30390135

ASTM Class 1 Weight Sets

Adjusted to meet ASTM Class 1 Tolerances

- Can be used as a reference standard in calibrating other weights and is appropriate for calibrating high-precision analytical balances with a readability as low as 0.1 mg to 0.01 mg.
- Weights are designed so the specifications on surface finish, markings, construction, material density, and magnetic properties become more restrictive as the weight tolerances decrease.
- Weight sets 500 g and below include a polycarbonate case. Weight sets where the largest weight is 1 kg and above are supplied in a tough, lightweight, rugged case, designed to protect your weight set under any shipping circumstance.



Without Certificate	
Model	Item No.
50 kg-1 g	30391360
50 kg-1 mg	30391359
30 kg-1 g	30391358
30 kg-1 mg	30391357
25 kg-1 g	30391356
25 kg-1 mg	30391355
20 kg-1 g	30391354
20 kg-1 mg	30391353
10 kg-1 g	30391352
10 kg-1 mg	30391351
5 kg-1 g	30391350
5 kg-1 mg	30391349
2 - 2 kg-1 g	30390054
2 - 2 kg-1 mg	30390053
2 kg-1 g	30391348
2 kg-1 mg	30391347
1 kg-1 g	30391346
1 kg-1 mg	30391345
500 g-1 g	30391344
500 g-1 mg	30391343
2 - 200 g-1 g	80781033
2 - 200 g-1 mg	80781031
200 g-1 g	30391342
200 g-1 mg	30391341
100 g-1 g	80781029
100 g-100 mg	30391340
100 g-10 mg	30391339
100 g-5 mg	30391338
100 g-1 mg	80781027
50 g-1 g	80781025
50 g-100 mg	30391337
50 g-10 mg	30391336
50 g- 5 mg	30391335
50 g-1 mg	80781023
20 g-1 g	30391334
20 g-100 mg	30391333
20 g-10 mg	30391332
20 g-5 mg	30391331
20 g-1 mg	30391330
500 mg-10 mg	30391329
500 mg-1 mg	80781021

Traceable Certificate	
Model	Item No.
50 kg-1 g	30391574
50 kg-1 mg	30391573
30 kg-1 g	30391572
30 kg-1 mg	30391571
25 kg-1 g	30391570
25 kg-1 mg	30391569
20 kg-1 g	30391568
20 kg-1 mg	30391567
10 kg-1 g	30391566
10 kg-1 mg	30391565
5 kg-1 g	30391564
5 kg-1 mg	30391563
2 - 2 kg-1 g	30390060
2 - 2 kg-1 mg	30390059
2 kg-1 g	30391562
2 kg-1 mg	30391561
1 kg-1 g	30391560
1 kg-1 mg	30391559
500 g-1 g	30391558
500 g-1 mg	30391557
2 - 200 g-1 g	30390058
2 - 200 g-1 mg	30390057
200 g-1 g	30391556
200 g-1 mg	30391555
100 g-1 g	30391554
100 g-100 mg	30391553
100 g-10 mg	30391552
100 g-5 mg	30391551
100 g-1 mg	30391550
50 g-1 g	30391549
50 g-100 mg	30391548
50 g-10 mg	30391547
50 g- 5 mg	30391546
50 g-1 mg	30391545
20 g-1 g	30391544
20 g-100 mg	30391543
20 g-10 mg	30391542
20 g-5 mg	30391541
20 g-1 mg	30391540
500 mg-10 mg	30391539
500 mg-1 mg	30391538

NVLAP Certificate	
Model	Item No.
50 kg-1 g	30391392
50 kg-1 mg	30391391
30 kg-1 g	30391390
30 kg-1 mg	30391389
25 kg-1 g	30391388
25 kg-1 mg	30391387
20 kg-1 g	30391386
20 kg-1 mg	30391385
10 kg-1 g	30391384
10 kg-1 mg	30391383
5 kg-1 g	30391382
5 kg-1 mg	30391381
2 - 2 kg-1 g	30390056
2 - 2 kg-1 mg	30390055
2 kg-1 g	30391380
2 kg-1 mg	30391379
1 kg-1 g	30391378
1 kg-1 mg	30391377
500 g-1 g	30391376
500 g-1 mg	30391375
2 - 200 g-1 g	80781034
2 - 200 g-1 mg	80781032
200 g-1 g	30391374
200 g-1 mg	30391373
100 g-1 g	80781030
100 g-100 mg	30391372
100 g-10 mg	30391371
100 g-5 mg	30391370
100 g-1 mg	80781028
50 g-1 g	80781026
50 g-100 mg	30391369
50 g-10 mg	30391368
50 g- 5 mg	30391367
50 g-1 mg	80781024
20 g-1 g	30391366
20 g-100 mg	30391365
20 g-10 mg	30391364
20 g-5 mg	30391363
20 g-1 mg	30391362
500 mg-10 mg	30391361
500 mg-1 mg	80781022

ASTM Class 4 Weight Sets

Adjusted to meet ASTM Class 4 Tolerances

- Can be used for calibration of semi-analytical balances and for student use.
- Weights are designed so the specifications on surface finish, markings, construction, material density, and magnetic properties become more restrictive as the weight tolerances decrease.
- Weight sets 500 g and below include a polycarbonate case. Weight sets where the largest weight is 1 kg and above are supplied in a tough, lightweight, rugged case, designed to protect your weight set under any shipping circumstance.



Without Certificate	
Model	Item No.
50 kg - 1 g	30391228
50 kg - 1 mg	30391227
30 kg - 1 g	30391226
30 kg - 1 mg	30391225
25 kg - 1 g	30391224
25 kg - 1mg	30391223
20 kg - 1 g	30391222
20 kg - 1 mg	30391221
10 kg - 1 g	30391220
10 kg -1 mg	30391219
5 kg -1 g	30391218
5 kg - 1 mg	30391217
2 - 2kg-1 g	30390048
2 - 2 kg-1 mg	30390047
2 kg - 1 g	30391216
2 kg - 1 mg	30391215
1 kg - 1 g	30391214
1 kg - 1 mg	30391213
500 g - 1 g	30391212
500 g - 1 mg	30391211
2 - 200 g - 1 g	30390046
2 - 200 g - 1 mg	30390045
200 g - 1 g	30391210
200 g - 1 mg	30391209
100 g - 1 g	30391208
100 g - 100 mg	30391207
100 g - 10 mg	30391206
100 g - 5 mg	30391205
100 g - 1 mg	80780101
50 g - 1 g	30391204
50 g - 100 mg	30391203
50 g - 10 mg	30391202
50 g - 5 mg	30391201
50 g - 1 mg	80780111
20 g - 1 g	30391200
20 g - 100 mg	30391199
20 g - 10 mg	30391198
20 g - 5 mg	30391197
20 g - 1 mg	30391196
500 mg - 10 mg	30391195
500 mg - 1 mg	80780100

Traceable Certificate	
Model	Item No.
50 kg - 1 g	30391075
50 kg - 1 mg	30391074
30 kg - 1 g	30391073
30 kg - 1 mg	30391072
25 kg - 1 g	30391071
25 kg - 1mg	30391070
20 kg - 1 g	30391069
20 kg - 1 mg	30391068
10 kg - 1 g	30391067
10 kg -1 mg	30391066
5 kg -1 g	30391065
5 kg - 1 mg	30391064
2 - 2kg-1 g	30390044
2 - 2 kg-1 mg	30390043
2 kg - 1 g	30391063
2 kg - 1 mg	30391062
1 kg - 1 g	30391061
1 kg - 1 mg	30391060
500 g - 1 g	30391059
500 g - 1 mg	30391058
2 - 200 g - 1 g	30390042
2 - 200 g - 1 mg	30390041
200 g - 1 g	30391057
200 g - 1 mg	30391056
100 g - 1 g	30391055
100 g - 100 mg	30391054
100 g - 10 mg	30391053
100 g - 5 mg	30391052
100 g - 1 mg	30391051
50 g - 1 g	30391050
50 g - 100 mg	30391049
50 g - 10 mg	30391048
50 g - 5 mg	30391047
50 g - 1 mg	30391046
20 g - 1 g	30391045
20 g - 100 mg	30391044
20 g - 10 mg	30391043
20 g - 5 mg	30391042
20 g - 1 mg	30391041
500 mg - 10 mg	30391040
500 mg - 1 mg	30391039

NVLAP Certificate	
Model	Item No.
50 kg - 1 g	30391262
50 kg - 1 mg	30391261
30 kg - 1 g	30391260
30 kg - 1 mg	30391259
25 kg - 1 g	30391258
25 kg - 1mg	30391257
20 kg - 1 g	30391256
20 kg - 1 mg	30391255
10 kg - 1 g	30391254
10 kg -1 mg	30391253
5 kg -1 g	30391252
5 kg - 1 mg	30391251
2 - 2kg-1 g	30390052
2 - 2 kg-1 mg	30390051
2 kg - 1 g	30391250
2 kg - 1 mg	30391249
1 kg - 1 g	30391248
1 kg - 1 mg	30391247
500 g - 1 g	30391246
500 g - 1 mg	30391245
2 - 200 g - 1 g	30390050
2 - 200 g - 1 mg	30390049
200 g - 1 g	30391244
200 g - 1 mg	30391243
100 g - 1 g	30391242
100 g - 100 mg	30391241
100 g - 10 mg	30391240
100 g - 5 mg	30391239
100 g - 1 mg	80850265
50 g - 1 g	30391238
50 g - 100 mg	30391237
50 g - 10 mg	30391236
50 g - 5 mg	30391235
50 g - 1 mg	80850264
20 g - 1 g	30391234
20 g - 100 mg	30391233
20 g - 10 mg	30391232
20 g - 5 mg	30391231
20 g - 1 mg	30391230
500 mg - 10 mg	30391229
500 mg - 1 mg	80850263

ASTM Class 1 Electronic Balance Weights

Adjusted to meet ASTM Class 1 Tolerances

- Can be used to check or verify the accuracy of your balance and/or scale between calibrations.
- Weights are available in a cylindrical design up through 5 kg and a stackable grip-handle design from 5 kg through 30 kg for all necessary testing, calibration and adjustment of electronic scales and balances.
- Weights 10 g through 10 kg are supplied in a high quality polycarbonate case; a nylon glove is included to protect weights during use.



Without Certificate	
Model	Item No.
30 kg grip	80781007
25 kg grip	30391488
24 kg grip	30391487
20 kg grip	80781005
16 kg grip	30391485
10 kg grip	80781003
8 kg grip	30391483
5 kg grip	80781001
5 kg cyl	30391481
4 kg grip	30391480
4 kg cyl	80780027
3 kg cyl	30391478
2 kg cyl	80780024
1500 g cyl	30391476
1000 g cyl	80780021
600 g cyl	30391474
500 g cyl	80780029
400 g cyl	80780026
300 g cyl	30391471
200 g cyl	80780023
160 g cyl	30391469
150 g cyl	30391468
100 g cyl	80780020
80 g cyl	30391466
70 g cyl	30391465
60 g cyl	30391464
50 g cyl	80780028
40 g cyl	80780025
30 g cyl	30391461
20 g cyl	80780022
10 g cyl	30391459

Traceable Certificate	
Model	Item No.
30 kg grip	30391520
25 kg grip	30391519
24 kg grip	30391518
20 kg grip	30391517
16 kg grip	30391516
10 kg grip	30391515
8 kg grip	30391514
5 kg grip	30391513
5 kg cyl	30391512
4 kg grip	30391511
4 kg cyl	30391510
3 kg cyl	30391509
2 kg cyl	30391508
1500 g cyl	30391507
1000 g cyl	30391506
600 g cyl	30391505
500 g cyl	30391504
400 g cyl	30391503
300 g cyl	30391502
200 g cyl	30391501
160 g cyl	30391500
150 g cyl	30391499
100 g cyl	30391498
80 g cyl	30391497
70 g cyl	30391496
60 g cyl	30391495
50 g cyl	30391494
40 g cyl	30391493
30 g cyl	30391492
20 g cyl	30391491
10 g cyl	30391490

NVLAP Certificate	
Model	Item No.
30 kg grip	80781008
25 kg grip	30391537
24 kg grip	30391536
20 kg grip	80781006
16 kg grip	30391535
10 kg grip	80781004
8 kg grip	30391534
5 kg grip	80781002
5 kg cyl	30391533
4 kg grip	30391532
4 kg cyl	80850275
3 kg cyl	30391531
2 kg cyl	80850272
1500 g cyl	30391530
1000 g cyl	80850269
600 g cyl	30391529
500 g cyl	80850277
400 g cyl	80850274
300 g cyl	30391528
200 g cyl	80850271
160 g cyl	30391527
150 g cyl	30391526
100 g cyl	80850268
80 g cyl	30391525
70 g cyl	30391524
60 g cyl	30391523
50 g cyl	80850276
40 g cyl	80850273
30 g cyl	30391522
20 g cyl	80850270
10 g cyl	30391521

ASTM Class 4 Electronic Balance Weights

Adjusted to meet ASTM Class 4 Tolerances

- Can be used to check or verify the accuracy of your balance and/or scale between calibrations.
- Weights are available in a cylindrical design up through 5 kg and a stackable grip-handle design from 5 kg through 30 kg for all necessary testing, calibration and adjustment of electronic scales and balances.
- Weights 10 g through 10 kg are supplied in a high quality polycarbonate case; a nylon glove is included to protect weights during use.



Without Certificate	
Model	Item No.
30 kg grip	30391139
25 kg grip	30391138
24 kg grip	30391137
20 kg grip	30391136
16 kg grip	30391135
10 kg grip	30391134
8 kg grip	30391133
5 kg grip	30391132
5 kg cyl	30391131
4 kg grip	30391130
4 kg cyl	30391129
3 kg cyl	30391128
2 kg cyl	80780145
1500 g cyl	30391126
1000 g cyl	80780143
600 g cyl	30391124
500 g cyl	80780141
400 g cyl	80780139
300 g cyl	80780137
200 g cyl	80780135
160 g cyl	30391119
150 g cyl	30391118
100 g cyl	80780133
80 g cyl	30391116
70 g cyl	30391115
60 g cyl	30391114
50 g cyl	30391113
40 g cyl	30391112
30 g cyl	30391111
20 g cyl	30391110
10 g cyl	30391109

Traceable Certificate	
Model	Item No.
30 kg grip	30391170
25 kg grip	30391169
24 kg grip	30391168
20 kg grip	30391167
16 kg grip	30391166
10 kg grip	30391165
8 kg grip	30391164
5 kg grip	30391163
5 kg cyl	30391162
4 kg grip	30391161
4 kg cyl	30391160
3 kg cyl	30391159
2 kg cyl	30391158
1500 g cyl	30391157
1000 g cyl	30391156
600 g cyl	30391155
500 g cyl	30391154
400 g cyl	30391153
300 g cyl	30391152
200 g cyl	30391151
160 g cyl	30391150
150 g cyl	30391149
100 g cyl	30391148
80 g cyl	30391147
70 g cyl	30391146
60 g cyl	30391145
50 g cyl	30391144
40 g cyl	30391143
30 g cyl	30391142
20 g cyl	30391141
10 g cyl	30391140

NVLAP Certificate	
Model	Item No.
30 kg grip	30391194
25 kg grip	30391193
24 kg grip	30391192
20 kg grip	30391191
16 kg grip	30391190
10 kg grip	30391189
8 kg grip	30391188
5 kg grip	30391187
5 kg cyl	30391186
4 kg grip	30391185
4 kg cyl	30391184
3 kg cyl	30391183
2 kg cyl	80780146
1500 g cyl	30391182
1000 g cyl	80780144
600 g cyl	30391181
500 g cyl	80780142
400 g cyl	80780140
300 g cyl	80780138
200 g cyl	80780136
160 g cyl	30391180
150 g cyl	30391179
100 g cyl	80780134
80 g cyl	30391178
70 g cyl	30391177
60 g cyl	30391176
50 g cyl	30391175
40 g cyl	30391174
30 g cyl	30391173
20 g cyl	30391172
10 g cyl	30391171

OIML E1 & E2 Individual Weights

Manufactured to meet OIML R 111 weight specifications

- OIML R 111 weight specifications are designed so the specifications on surface finish, markings, construction, material density and magnetic properties become more restrictive as weight tolerances decrease in order to enable the weight to maintain its tolerance over time.
- Weights 1 g and above are one-piece construction. Weights 1 g and larger are cylindrical in shape with a tapered neck for easy gripping. They are perfectly flat on top to stack easily on center. Weight bottoms are slightly recessed to expose the smallest possible area to wear.
- Individual weights 1 mg through 10 kg are supplied in durable polycarbonate cases. Case lids lock tightly to ensure that your weight is held securely and kept clean and dust free.



E1 Weights NVLAP	
Model	Item No.
50 kg	30390927
20 kg	30390928
10 kg	30390929
5 kg	30390930
2 kg	30390931
1 kg	30390932
500 g	30390933
200 g	30390934
100 g	30390935
50 g	30390936
20 g	30390937
10 g	30390938
5 g	30390939
2 g	30390940
1 g	30390941
500 mg	30390942
200 mg	30390943
100 mg	30390944
50 mg	30390945
20 mg	30390946
10 mg	30390947
5 mg	30390948
2 mg	30390949
1 mg	30390950

E2 Weights NVLAP	
Model	Item No.
50 kg	30390903
20 kg	80780306
10 kg	80780305
5 kg	80780304
2 kg	80780303
1 kg	80780302
500 g	80780301
200 g	80780300
100 g	80780299
50 g	80780298
20 g	80780297
10 g	80780296
5 g	80780295
2 g	80780294
1 g	80780293
500 mg	80780292
200 mg	80780291
100 mg	80780290
50 mg	80780289
20 mg	80780288
10 mg	80780287
5 mg	80780286
2 mg	80780285
1 mg	80780284

OIML F1 & F2 Individual Weights

Manufactured to meet OIML R 111 weight specifications

- OIML R 111 weight specifications are designed so the specifications on surface finish, markings, construction, material density and magnetic properties become more restrictive as weight tolerances decrease in order to enable the weight to maintain its tolerance over time.
- Weights 1 g and above are two-piece construction. OIML Calibration Weights 1 g and larger are cylindrical in shape with a tapered neck for easy gripping. They are perfectly flat on top to stack easily on center. Weight bottoms are slightly recessed to expose the smallest possible area to wear.
- Individual weights 1 mg through 10 kg are supplied in durable polycarbonate cases. Case lids lock tightly to ensure that your weight is held securely and kept clean and dust free.



F1 Weights Without Certificate	
Model	Item No.
50 kg	80780330
20 kg	80780329
10 kg	80780328
5 kg	80780327
2 kg	80780326
1 kg	80780325
500 g	80780324
200 g	80780323
100 g	80780322
50 g	80780321
20 g	80780320
10 g	80780319
5 g	80780318
2 g	80780317
1 g	80780316
500 mg	80780315
200 mg	80780314
100 mg	80780313
50 mg	80780312
20 mg	80780311
10 mg	80780310
5 mg	80780309
2 mg	80780308
1 mg	80780307

F1 Weights NVLAP Certificate	
Model	Item No.
50 kg	30390901
20 kg	80780353
10 kg	80780352
5 kg	80780351
2 kg	80780350
1 kg	80780349
500 g	80780348
200 g	80780347
100 g	80780346
50 g	80780345
20 g	80780344
10 g	80780343
5 g	80780342
2 g	80780341
1 g	80780340
500 mg	80780339
200 mg	80780338
100 mg	80780337
50 mg	80780336
20 mg	80780335
10 mg	80780334
5 mg	80780333
2 mg	80780332
1 mg	80780331

F2 Weights Without Certificate	
Model	Item No.
50 kg	30390853
20 kg	30390854
10 kg	30390855
5 kg	30390856
2 kg	30390857
1 kg	30390858
500 g	30390859
200 g	30390860
100 g	30390861
50 g	30390862
20 g	30390863
10 g	30390864
5 g	30390865
2 g	30390866
1 g	30390867
500 mg	30390868
200 mg	30390869
100 mg	30390870
50 mg	30390871
20 mg	30390872
10 mg	30390873
5 mg	30390874
2 mg	30390875
1 mg	30390876

F2 Weights NVLAP Certificate	
Model	Item No.
50 kg	30390877
20 kg	30390878
10 kg	30390879
5 kg	30390880
2 kg	30390881
1 kg	30390882
500 g	30390883
200 g	30390884
100 g	30390885
50 g	30390886
20 g	30390887
10 g	30390888
5 g	30390889
2 g	30390890
1 g	30390891
500 mg	30390892
200 mg	30390893
100 mg	30390894
50 mg	30390895
20 mg	30390896
10 mg	30390897
5 mg	30390898
2 mg	30390899
1 mg	30390900

OIML E1 & E2 Weight Sets

Manufactured to meet OIML R 111 weight specifications



- OIML R 111 weight specifications are designed so the specifications on surface finish, markings, construction, material density and magnetic properties become more restrictive as weight tolerances decrease in order to enable the weight to maintain its tolerance over time.
- Weights 1 g and above are one-piece construction. Weights 1 g and larger are cylindrical in shape with a tapered neck for easy gripping. They are perfectly flat on top to stack easily on center. Weight bottoms are slightly recessed to expose the smallest possible area to wear.
- Weight sets 500 g and below include a polycarbonate case. Weight sets where the largest weight is 1 kg and above are supplied in a tough, lightweight, rugged case, designed to protect your weight set under any shipping circumstance.

E1 Sets NVLAP	
Model	Item No.
50 kg - 1 g	30390904
50 kg - 1 mg	30390905
20 kg - 1 g	30390906
20 kg - 1 mg	30390907
10 kg - 1 g	30390908
10 kg - 1 mg	30390909
5 kg-1 kg	30390910
5 kg - 1 g	30390911
5 kg - 1 mg	30390912
2 kg - 1 g	30390913
2 kg - 1 mg	30390914
(2) 2 kg - 1 g	30390037
(2) 2 kg - 1 mg	30390038
1 kg - 1 g	30390915
1 kg - 1 mg	30390916
500 g - 1 g	30390917
500 g - 1 mg	30390918
200 g - 1 g	30390919
200 g - 1 mg	30390920
(2) 200 g - 1 g	30390039
(2) 200 g - 1 mg	30390040
100 g - 1 g	30390921
100 g - 1 mg	30390922
50 g - 1 g	30390923
50 g - 1 mg	30390924
5 g - 1 mg	30390925
500 mg - 1 mg	30390926

E2 Sets NVLAP	
Model	Item No.
50 kg - 1 g	80780407
50 kg - 1 mg	80780406
20 kg - 1 g	80780405
20 kg - 1 mg	80780404
10 kg - 1 g	80780403
10 kg - 1 mg	80780402
5 kg-1 kg	80780401
5 kg - 1 g	80780400
5 kg - 1 mg	80780399
2 kg - 1 g	80780398
2 kg - 1 mg	80780397
(2) 2 kg - 1 g	80780396
(2) 2 kg - 1 mg	80780395
1 kg - 1 g	80780394
1 kg - 1 mg	80780393
500 g - 1 g	80780392
500 g - 1 mg	80780391
200 g - 1 g	80780390
200 g - 1 mg	80780389
(2) 200 g - 1 g	80780388
(2) 200 g - 1 mg	80780387
100 g - 1 g	80780386
100 g - 1 mg	80780385
50 g - 1 g	80780384
50 g - 1 mg	80780383
5 g - 1 mg	80780382
500 mg - 1 mg	80780381

OIML F1 & F2 Weight Sets

Manufactured to meet OIML R 111 weight specifications



- OIML R 111 weight specifications are designed so the specifications on surface finish, markings, construction, material density and magnetic properties become more restrictive as weight tolerances decrease in order to enable the weight to maintain its tolerance over time.
- Weights 1 g and above are two-piece construction. OIML Calibration Weights 1 g and larger are cylindrical in shape with a tapered neck for easy gripping. They are perfectly flat on top to stack easily on center. Weight bottoms are slightly recessed to expose the smallest possible area to wear.
- Weight sets 500 g and below include a polycarbonate case. Weight sets where the largest weight is 1 kg and above are supplied in a tough, lightweight, rugged case, designed to protect your weight set under any shipping circumstance.

F1 Weights Without Certificate	
Model	Item No.
50 kg - 1 g	80780434
50 kg - 1 mg	80780433
20 kg - 1 g	80780432
20 kg - 1 mg	80780431
10 kg - 1 g	80780430
10 kg - 1 mg	80780429
5 kg - 1 g	80780428
5 kg - 1 mg	80780427
5 kg - 1 mg	80780426
2 kg - 1 g	80780425
2 kg - 1 mg	80780424
(2) 2 kg - 1 g	80780423
(2) 2 kg - 1 mg	80780422
1 kg - 1 g	80780421
1 kg - 1 mg	80780420
500 g - 1 g	80780419
500 g - 1 mg	80780418
200 g - 1 g	80780417
200 g - 1 mg	80780416
(2) 200 g - 1 g	80780415
(2) 200 g - 1 mg	80780414
100 g - 1 g	80780413
100 g - 1 mg	80780412
50 g - 1 g	80780411
50 g - 1 mg	80780410
5 g - 1 mg	80780409
500 mg - 1 mg	80780408

F1 Weights NVLAP Certificate	
Model	Item No.
50 kg - 1 g	80780461
50 kg - 1 mg	80780460
20 kg - 1 g	80780459
20 kg - 1 mg	80780458
10 kg - 1 g	80780457
10 kg - 1 mg	80780456
5 kg - 1 g	80780455
5 kg - 1 g	80780454
5 kg - 1 mg	80780453
2 kg - 1 g	80780452
2 kg - 1 mg	80780451
(2) 2 kg - 1 g	80780450
(2) 2 kg - 1 mg	80780449
1 kg - 1 g	80780448
1 kg - 1 mg	80780447
500 g - 1 g	80780446
500 g - 1 mg	80780445
200 g - 1 g	80780444
200 g - 1 mg	80780443
(2) 200 g - 1 g	80780442
(2) 200 g - 1 mg	80780441
100 g - 1 g	80780440
100 g - 1 mg	80780439
50 g - 1 g	80780438
50 g - 1 mg	80780437
5 g - 1 mg	80780436
500 mg - 1 mg	80780435

F2 Weights Without Certificate	
Model	Item No.
50 kg - 1 g	30390807
50 kg - 1 mg	30390808
20 kg - 1 g	30390809
20 kg - 1 mg	30390810
10 kg - 1 g	30390811
10 kg - 1 mg	30390812
5 kg - 1 g	30390813
5 kg - 1 g	30390814
5 kg - 1 mg	30390815
2 kg - 1 g	30390816
2 kg - 1 mg	30390817
(2) 2 kg - 1 g	30390029
(2) 2 kg - 1 mg	30390030
1 kg - 1 g	30390818
1 kg - 1 mg	30390819
500 g - 1 g	30390820
500 g - 1 mg	30390821
200 g - 1 g	30390822
200 g - 1 mg	30390823
(2) 200 g - 1 g	30390031
(2) 200 g - 1 mg	30390032
100 g - 1 g	30390824
100 g - 1 mg	30390825
50 g - 1 g	30390826
50 g - 1 mg	30390827
5 g - 1 mg	30390828
500 mg - 1 mg	30390829

F2 Weights NVLAP Certificate	
Model	Item No.
50 kg - 1 g	30390830
50 kg - 1 mg	30390831
20 kg - 1 g	30390832
20 kg - 1 mg	30390833
10 kg - 1 g	30390834
10 kg - 1 mg	30390835
5 kg - 1 g	30390836
5 kg - 1 g	30390837
5 kg - 1 mg	30390838
2 kg - 1 g	30390839
2 kg - 1 mg	30390840
(2) 2 kg - 1 g	30390033
(2) 2 kg - 1 mg	30390034
1 kg - 1 g	30390841
1 kg - 1 mg	30390842
500 g - 1 g	30390843
500 g - 1 mg	30390844
200 g - 1 g	30390845
200 g - 1 mg	30390846
(2) 200 g - 1 g	30390035
(2) 200 g - 1 mg	30390036
100 g - 1 g	30390847
100 g - 1 mg	30390848
50 g - 1 g	30390849
50 g - 1 mg	30390850
5 g - 1 mg	30390851
500 mg - 1 mg	30390852

ASTM Class 6 Weights - Cylindrical Adjusted to Meet or Exceed ASTM Class 6 Tolerances

- Weights from 1 g to 2 kg are Stainless Steel and Weights 500 mg and below are Aluminum.
- Weight Sets include a Weight Case.
- Individual Weights do not include a case



Cylindrical Weights

Model	Item No.
Weight Set, 500 mg-1 mg, ASTM 6, Cyl	80850110
Weight Set, 50 g-10 mg, ASTM 6, Cyl	80850111
Weight Set, 100 g-1 mg, ASTM 6, Cyl	80850112
Weight Set, 200 g-1 mg, ASTM 6, Cyl	80850113
Weight Set, 500 g-1 g, ASTM 6, Cyl	80850114
Weight Set, 1 kg-1 g, ASTM 6, Cyl	80850115
Weight Set, 2 kg-1 g, ASTM 6, Cyl	80850116
Weight Set, 50 g-1 g, ASTM 6, Cyl	80850117
Weight, 1 g, ASTM 6, Cyl, Body	80850118
Weight, 2 g, ASTM 6, Cyl, Body	80850119
Weight, 5 g, ASTM 6, Cyl, Body	80850120
Weight, 10 g, ASTM 6, Cyl, Body	80850121
Weight, 20 g, ASTM 6, Cyl, Body	80850122
Weight, 50 g, ASTM 6, Cyl, Body	80850123
Weight, 100 g, ASTM 6, Cyl, Body	80850124
Weight, 200 g, ASTM 6, Cyl, Body	80850125
Weight, 300 g, ASTM 6, Cyl, Body	80850126
Weight, 500 g, ASTM 6, Cyl, Body	80850127
Weight, 1 kg, ASTM 6, Cyl, Body	80850128
Weight, 2 kg, ASTM 6, Cyl, Body	80850129

Hooked Weights

Model	Item No.
Weight Set, 1 kg-10 g, ASTM 6, Hooked	80850130
Weight, 10 g, Hooked	80850131
Weight, 20 g, Hooked	80850132
Weight, 50 g, Hooked	80850133
Weight, 100 g, Hooked	80850134
Weight, 200 g, Hooked	80850135
Weight, 500 g, Hooked	80850136
Weight, 1 kg, Hooked	80850137

Slotted Weights

Model	Item No.
Weight Set, Slotted 500 g-10 g	80850138
Weight Set, Slotted 500 g-1 g	80850139
Weight Set, 1 g, ASTM 6, Slotted	80850140
Weight Set, 2 g, ASTM 6, Slotted	80850141
Weight Set, 5 g, ASTM 6, Slotted	80850142
Weight Set, 10 g, ASTM 6, Slotted	80850143
Weight Set, 20 g, ASTM 6, Slotted	80850144
Weight Set, 50 g, ASTM 6, Slotted	80850145
Weight Set, 100 g, ASTM 6, Slotted	80850146
Weight Set, 200 g, ASTM 6, Slotted	80850147
Weight Set, 500 g, ASTM 6, Slotted	80850148
Weight, 50 g, Hanger	80850149

NIST Class F Cast Iron Grip Weights

Manufactured to meet NIST Handbook 105-1 specifications

- Cast Iron Grip Handle Weights are primarily used to test commercial weighing devices by state and local weights and measures officials, device installers, and service technicians.
- Cast Iron Grip Handle Weights larger than 5 kg/10 lb are legal-for-trade, which means their design is acceptable for use in checking weighing devices where the price of the item being purchased is based on its weight.
- All surfaces are smooth and free of scratches, dents and pores as outlined in NIST Handbook 105-1.



Without Certificate	
Model	Item No.
5000 lb	30391735
3000 lb	30391734
2500 lb	30391733
2000 lb	30391732
1500 lb	30391731
1250 lb	30391730
1000 lb	30391729
500 lb	30391728
250 lb	30391727
200 lb	30391726
100 lb	80850311
50 lb	80850310
30 lb	30391723
25 lb	80850309
20 lb	80850308
10 lb	80850307
5 lb	80850306

Traceable Certificate	
Model	Item No.
5000 lb	30391764
3000 lb	30391763
2500 lb	30391762
2000 lb	30391761
1500 lb	30391760
1250 lb	30391759
1000 lb	30391758
500 lb	30391757
250 lb	30391756
200 lb	30391755
100 lb	30391754
50 lb	30391753
30 lb	30391752
25 lb	30391751
20 lb	30391750
10 lb	30391749
5 lb	30391748

NVLAP Certificate	
Model	Item No.
5000 lb	30391781
3000 lb	30391780
2500 lb	30391779
2000 lb	30391778
1500 lb	30391777
1250 lb	30391776
1000 lb	30391775
500 lb	30391774
250 lb	30391773
200 lb	30391772
100 lb	30391771
50 lb	30391770
30 lb	30391769
25 lb	30391768
20 lb	30391767
10 lb	30391766
5 lb	30391765

Without Certificate	
Model	Item No.
1000 kg	30391717
500 kg	30391716
250 kg	30391715
200 kg	30391714
100 kg	30391713
50 kg	80850305
25 kg	80850304
20 kg	80850303
10 kg	80850302
5 kg	80850301
2 kg	80850300

Traceable Certificate	
Model	Item No.
1000 kg	30391746
500 kg	30391745
250 kg	30391744
200 kg	30391743
100 kg	30391742
50 kg	30391741
25 kg	30391740
20 kg	30391739
10 kg	30391738
5 kg	30391737
2 kg	30391736

NVLAP Certificate	
Model	Item No.
1000 kg	30391705
500 kg	30391704
250 kg	30391703
200 kg	30391702
100 kg	30391701
50 kg	30391700
25 kg	30391699
20 kg	30391698
10 kg	30391697
5 kg	30391696
2 kg	30391695

NIST Class F Stainless Steel Individual Weights

Manufactured to meet NIST Handbook 105-1 specifications

- Stainless Steel Test Weights are primarily used to test commercial weighing devices by state and local weights and measures officials, device installers, and service technicians.
- Weights 5 kg /10 lb and below must be made of stainless steel of quality no lower than 300 series. Adjusting cavities are typically on the top of the weight and must be tamper resistant.
- All surfaces have a satin finish and conform to specifications in NIST Handbook 105-1.



Without Certificate	
Model	Item No.
20 kg grip	30390593
16 kg grip	30390592
10 kg grip	30390591
8 kg grip	30390590
5 kg grip	30390589
5000 g	30390588
4000 g	30390587
3000 g	30390586
2000 g	30390585
1000 g	30390584
500 g	30390582
400 g	30390580
300 g	30390579
200 g	30390577
100 g	30390575
50 g	30390573
30 g	30390572
20 g	30390571
10 g	30390570
5 g	30390569
3 g	30390568
2 g	30390567
1 g	30390566

Traceable Certificate	
Model	Item No.
20 kg grip	30390657
16 kg grip	30390656
10 kg grip	30390655
8 kg grip	30390654
5 kg grip	30390653
5000 g	30390652
4000 g	30390651
3000 g	30390650
2000 g	30390649
1000 g	30390648
500 g	30390646
400 g	30390644
300 g	30390643
200 g	30390641
100 g	30390639
50 g	30390637
30 g	30390636
20 g	30390635
10 g	30390634
5 g	30390633
3 g	30390632
2 g	30390631
1 g	30390630

NVLAP Certificate	
Model	Item No.
20 kg grip	30390721
16 kg grip	30390720
10 kg grip	30390719
8 kg grip	30390718
5 kg grip	30390717
5000 g	30390716
4000 g	30390715
3000 g	30390714
2000 g	30390713
1000 g	30390712
500 g	30390710
400 g	30390708
300 g	30390707
200 g	30390705
100 g	30390703
50 g	30390701
30 g	30390700
20 g	30390699
10 g	30390698
5 g	30390697
3 g	30390696
2 g	30390695
1 g	30390694

Without Certificate	
Model	Item No.
20 lb. grip	30390550
10 lb. grip	30390549
10 lb.	30390548
5 lb.	30390547
4 lb.	30390546
3 lb.	30390545
2 lb.	30390544
1 lb.	30390542
12 oz	30390540
8 oz	30390539
8 oz cube	30390538
4 oz	30390537
4 oz cube	30390536
2 oz	30390535
2 oz cube	30390534
1 oz	30390533

Traceable Certificate	
Model	Item No.
20 lb. grip	30390614
10 lb. grip	30390613
10 lb.	30390612
5 lb.	30390611
4 lb.	30390610
3 lb.	30390609
2 lb.	30390608
1 lb.	30390606
12 oz	30390604
8 oz	30390603
8 oz cube	30390602
4 oz	30390601
4 oz cube	30390600
2 oz	30390599
2 oz cube	30390598
1 oz	30390597

NVLAP Certificate	
Model	Item No.
20 lb. grip	30390678
10 lb. grip	30390677
10 lb.	30390676
5 lb.	30390675
4 lb.	30390674
3 lb.	30390673
2 lb.	30390672
1 lb.	30390670
12 oz	30390668
8 oz	30390667
8 oz cube	30390666
4 oz	30390665
4 oz cube	30390664
2 oz	30390663
2 oz cube	30390662
1 oz	30390661



NIST Class F Stainless Steel Weight Sets

Manufactured to meet NIST Handbook 105-1 specifications

- Stainless Steel Test Weights are primarily used to test commercial weighing devices by state and local weights and measures officials, device installers, and service technicians.
- Weights 5 kg /10 lb and below must be made of stainless steel of quality no lower than 300 series. Adjusting cavities are typically on the top of the weight and must be tamper resistant.
- All surfaces have a satin finish and conform to specifications in NIST Handbook 105-1.



Without Certificate	
Model	Item No.
5000 g-1 mg	30390403
5000 g-1 mg	30390397
5000 g-1 g	30390405
5000 g-1 g	30390399
2000 g-1 mg	30390406
2000 g-1 g	30390408
2000 g-10 mg	30390407
2000 g-1 mg	30390400
1000 g-1 g	30390411
500 g-1 g	30390414
100 g-1 mg	30390415
50 g-1 g	30390420
50 g-10 mg	30390419

Traceable Certificate	
Model	Item No.
5000 g-1 mg	30390459
5000 g-1 mg	30390453
5000 g-1 g	30390461
5000 g-1 g	30390455
2000 g-1 mg	30390462
2000 g-1 g	30390464
2000 g-10 mg	30390463
2000 g-1 mg	30390456
1000 g-1 g	30390467
500 g-1 g	30390470
100 g-1 mg	30390471
50 g-1 g	30390476
50 g-10 mg	30390475

NVLAP Certificate	
Model	Item No.
5000 g-1 mg	30390515
5000 g-1 mg	30390509
5000 g-1 g	30390517
5000 g-1 g	30390511
2000 g-1 mg	30390518
2000 g-1 g	30390520
2000 g-10 mg	30390519
2000 g-1 mg	30390512
1000 g-1 g	30390523
500 g-1 g	30390526
100 g-1 mg	30390527
50 g-1 g	30390532
50 g-10 mg	30390531

Without Certificate	
Model	Item No.
10 lb-1/32 oz	30390384
10 lb-.001 lb	30390383
5 lb-.001 lb	30390373
5 lb-.001 lb	30390375
5 lb-1/32 oz	30390376
5 lb-.05 oz	30390374
5 lb-1/32 oz	30390387
4 oz-1/32 oz	30390379
.2 lb-.001 lb	30390381

Traceable Certificate	
Model	Item No.
10 lb-1/32 oz	30390440
10 lb-.001 lb	30390439
5 lb-.001 lb	30390429
5 lb-.001 lb	30390431
5 lb-1/32 oz	30390432
5 lb-.05 oz	30390430
5 lb-1/32 oz	30390443
4 oz-1/32 oz	30390435
.2 lb-.001 lb	30390437

NVLAP Certificate	
Model	Item No.
10 lb-1/32 oz	30390496
10 lb-.001 lb	30390495
5 lb-.001 lb	30390485
5 lb-.001 lb	30390487
5 lb-1/32 oz	30390488
5 lb-.05 oz	30390486
5 lb-1/32 oz	30390499
4 oz-1/32 oz	30390491
.2 lb-.001 lb	30390493

SF40A

OHAUS Value in a Full-Featured, Portable Printer

- The statistics and totalization modes and real time clock complement OHAUS weighing instruments' application modes and offer functionality that assists the reporting processes.
- SF40A helps support the efficiency of the weighing and recording processes. RS232 interface and PC configuration software make setting up and using the printer fast and simple.
- With the ability to print in 13 different languages, SF40A can print in the language of the connected device to support universal operation.



- Application** Impact Printing, Statistics, Totalization
- Display** Not Applicable
- Operation** AC adapter (included)
- Communication** RS232 (included)
- Construction** ABS Housing
- Design Features** Status indicator, 40 characters per line, compatible with continuous label paper, perform zero and tare operations directly from the printer

Model	Item No.
SF40A	30064203



STP103

Economical Palm-Sized Thermal Printer

- This ultra compact printer has a very small footprint and also features very low power consumption, requiring limited resources from your workspace.
- The extremely fast STP103 offers 42 column printing at a speed of approximately 11.8 lines per second.
- Loading paper into the printer is quick and easy and when the paper becomes low, the printer will suspend printing in order to prevent printing errors resulting from lack of paper.



- Application** Thermal Printing
- Display** Not Applicable
- Operation** AC Adapter (Included)
- Communication** RS232 (included)
- Construction** ABS Housing
- Design Features** Status indicator, paper feeder, graphical printing capabilities

Model	Item No.
Printer, Thermal,STP103, 120vac US	80251992



Column Mounts

Accessories	Item No.
Column Kit, 98 cm, CS, TD52	30424412
Column Kit, 35 cm, SST, TD52	30424413
Column Kit, 68 cm, SST, TD52	30424414
Column Kit, 98 cm, SST, TD52	30424415
Print Holder Kit, TD52	30424025
Column Kit, 350mm, Painted, T31P	80251743
Column Kit, 700mm, Painted, T31P	80251744
Column Kit, 350mm, SST, T32XW	80251745
Column Kit, 700mm, SST, T32XW	80251746
Column Kit, 350mm, Painted, T51P T71P	80500723
Column Kit, 680mm, Painted, T51P T71P	80500724
Column Kit, 350mm, SST, T51XW T71XW	80500725
Column Kit, 680mm, SST, T51XW T71XW	80500726
Column Kit, EX	83021102

Density Determination Kits

Accessories	Item No.
Density Kit ,SP SPJ	71147378
Density Kit, Solids	80253384

Dust Covers

Accessories	Item No.
Dust Cover, Balance with Draft Shield	30093334
Stacking Kit, x6, STX SPX SKX SJX/E	30268987
Stacking Kit, x1, STX SPX SKX SJX/E	30268988
Dust Cover, Dial-O-Gram Cent-O-Gram	80780005
Dust Cover, Triple Beam	80780017
Dust Cover, Storage, Harvard	80850262

Interface Cables and Kits

Accessories	Item No.
Ethernet Kit, R31 RC31 R71 V71	30037447
RS232 Kit, R31 RC31 R71 V71	30037448
USB Kit, R31 RC31 V71	30037449
Cable, RS422, 9m, EX EX-HiCap	30078078
Cable, Extension, 9m, R71	30101495
Ethernet Kit, T72XW	30132163
USB with I/O Kit, T72XW	30132164
COM2 Kit, T72XW	30132165
USB Extension Cable, EX	30217067
RS232 Interface, STX SPX ST3100M	30268982
USB Host Interface, STX SPX	30268983
USB Device Interface, STX SPX ST3100M	30268984
Bluetooth Interface, STX SPX	30268985
Ethernet Interface, STX SPX	30268986
RS422/485 Kit, T51 T71	80500731
RS232 Kit, T51 T71	80500733
RS232 Kit, 2nd, AV	80850092

Adapters

Accessories	Item No.
Cable Kit, Loadcell Adapter, T51 T71	80500736
LC Extension Cable, 9 meters, D52	30424409
Load Cell Cable Adapter Kit, to D52 Base	30429931

Anti-Theft Devices

Accessories	Item No.
Anti-Theft Device, SP PA AV NV	80850000
Anti-Theft Device, MB AX EX	80850043

Auxiliary Displays

Accessories	Item No.
Auxiliary Display, TAD7, SP SPJ TA TAJ	80251395
Auxiliary Display, AD7-RS	30472064

Base Mounts

Accessories	Item No.
Base Mount Kit, Painted, T51P T71P	80500722
Handle Kit, D3K	30381321
Front Mount Kit, SS, TD52	30424024

Carrying Cases

Accessories	Item No.
Carrying Case, CS	80010624
Carrying Case, V31	80251216
Carrying Case, FD V51	80251394
Carrying Case, EB EC	80251532
Carrying Case, SP	80850028
Carrying Case, Ranger	80850083
Carrying Case, TR TC R31 TC31 V71	80850084
Carrying Case, NVT	83032224
Carrying Case, NVL	83032225
Carrying Case, NV	83032226
Portable Bag STARTER	30031635
Carrying Case, SD	30454761

Column Mounts

Accessories	Item No.
Column Kit, Painted, Floor Stand	30047153
Column Kit, SST, Floor Stand	30047154
Column Kit, EX-HiCap	30078082
Column Kit, Painted, R71	30095408
Column Kit, 230mm / 9" SST, T71XW to CKW Bases	30454644
Column Adapter, Painted, T31P T51P T71P	72209339
Column Adapter, SST, T32XW T51XW T71XW	72209340
Column Kit, 35 cm, CS, TD52	30424410
Column Kit, 68 cm, CS, TD52	30424411

Weighing & Measuring Accessories

Interface Cables and Kits

Accessories	Item No.
Ethernet Kit, EX EX-HiCap	83021082
Cable, USB, Type A-B	83021085
RS232 Kit, SP TA Navigator	83032107
USB Kit, SP TA NV NVL NVT	83032108
Ethernet Kit, NV NVL NVT	83032109
USB Kit, AV	83033014
Interface Kit, RS232-USB	30304101
Interface Kit, RS232-Ethernet	30304102
WiFi/BT Dongle, OHAUS (Requires 30424406)	30412537
USB Host for Dongle, TD52	30424406
Analog Output Kit, TD52	30424403
2nd RS232/RS485/USB, TD52	30424404
Ethernet Kit, TD52	30429666
Discrete I/O Kit, 2-In/4-Out, R71 TD52	30097591

In-Use Covers

Accessories	Item No.
In-Use-Cover, AR	12104951
In-Use-Cover, Small, RC RD RP	21203719
In-Use-Cover, V71	30037445
In-Use-Cover, R21 RC21 R31 RC31	30037451
In-Use-Cover, Set(10), V71	30037469
In-Use-Cover, STARTER	30058734
In-Use-Cover wo DS AX	30111777
In-Use-Cover DS AX	30111792
Accessory, In Use Cover, R71	30135320
In-Use-Cover, Scout	30269022
In-Use-Cover, Set(3), SP	71168909
In-Use-Cover, bRite A51 A71	72247038
In-Use-Cover, Pan, bRite A51 A71	72247039
Cover In-Use R11P RC11P	80120028
In-Use-Cover, FD V51	80251140
In-Use-Cover, MB23 MB27	80252475
In-Use-Cover, EP VP	80850042
In-Use-Cover, MB35 MB45	80850085
In-Use-Cover, PA	83020221
In-Use-Cover, NVT	83032221
In-Use-Cover, NVL	83032222
In-Use-Cover, NV	83032223
In-Use-Cover, Terminal, EX	83033633
In-Use-Cover, ST5000	30129897
In-use Cover Set, TD52P	30424022
In-use Cover Set, TD52XW	30424023
In-use Cover set (10), TD52P	30469948
In-use Cover set (10), TD52XW	30469949

Miscellaneous

Accessories	Item No.
Scoop, Gold	30020842
PCBA Kit, 2nd Platform, RC31 R41 RC41	30037446
Hook, R21 RC21 R31 RC31 R41 RC41 V71	30037450
Wheel Kit, Set(4), EX-HiCap	30041470
Holder, Attached, Electrode	30058732
Holder, Stand Alone, Electrode	30058733
PCBA Kit, 2nd Platform, R71	30097590
Static Ionizer, ION-100A, AM	30130302
Pipette Adjustment Kit, EX Semi-Micro	30252145
Thermal Printer Head Assy bRite A71 AM	72253293
Subject Box	80000053
PCBA Kit, Alibi Memory, R71 T71	80500503
Kit, Rod and Clamp	80780011
Test Tube, 310-00 311-00	80780018
Weight Set, 2 x 1 kg, 1 x 500 g	80780108
Clamp, Gas Cylinder	80850312
Cable, RS422, Extension, EX EX-HiCap	83021083
Draft Shield Kit, EX	83021084
Foot Switch Kit, EX EX-HiCap	83021086
Seal kit, STARTER portables	83032962
Wheel Kit, Defender up to 600 lb / 300 kg capacity	30372146
Light Tower, R-Y-G, IP65, 24VDC	30424021

Moisture Analyzer Accessories

Accessories	Item No.
Temp. Calibration Kit, MB Series	11113857
Holder, Pan, MB35 MB45	11113873
Scoop, Accessory, MB90 MB120	30284477
In-Use-Cover, Accessory, MB90 MB120	30284478
Holder, Pan, MB Series	80252476
Cage, Sample, MB Series	80252477
Pan, Reusable, Set(3), 7 mm, MB Series	80252478
Pan, Reusable, Set(3), 14 mm, MB Series	80252479
Pan, Aluminum, Set(100), MB200	80780012
Pan, Aluminum, Set(80), MB Series	80850086
Filter, Glass Fiber, Set(200)	80850087
Pan, Reusable(3), D90mm, MB45	80850088

Pans, Stands, Bowls

Accessories	Item No.
Pan, SST, R21 RC21 R31 RC31 V71	30037452
Platform, SST, 300x225mm, V22 V41	30251753
Pan Cover, SST, CL	80010623
Pan, SST, Flat, FD V51	80251141
Pan, SST, Sandwich, V31	80251147
Holder, SST, French Fries, V31	80251148
Holder, SST, Ice Cream Cone, V31	80251149
Pan, SST, C11P	80251248
Bowl, 1050ml, CS	80850075
Pan Cover, SST, CS	80850076

Printer Cables

Accessories	Item No.
Cable, PC, 9 Pin, NV AV	12106964
Cable, RS9 M/F, 1.5 m	12122603
Adapter, 9 Pin-9 Pin, PC-SF40A	30059316
Cable, RJ45-RS232, Printer, bRite A71	72249531
Adapter, 25 Pin-9 Pin, STP103	80251930
Adapter, 25 Pin -9 Pin, CBM910-SPU TA	80251934
Cable, RS232, CBM910-AV DV EX MB PA TxxP	80252571
Cable, RS232, CBM910-TC TR	80252573
Cable, RS232, CBM910-CKW TxxXW	80252574
Cable, ST103-AR EP VP	80252580
Cable, ST103-AV DV EX MB PA TxxP	80252581
Cable, ST103-TC TR	80252583
Cable, ST103-CKW55 TxxXW	80252584
Cable, 25 Pin-9 Pin, PC-TxxP	80500524
Cable, RS232, IBM 9P, AV DV MB Ranger TD52P	80500525
Cable, RS232 Connector, Ranger	80500526
Cable, RS232, CKW TxxXW	80500552
Cable, RS232, Ranger	80500556
Cable, SF42-AV DV MB Ranger	80500571
Adapter, 25 Pin-9 Pin, SF42 SRP275	80500572

Printer Supplies

Accessories	Item No.
Paper Roll, Set(5), SF42	12101511
Ink Ribbon, SF40A SF42A	12120798
Paper Roll, Set (2), 57.5mm, SF40A	12120799
Axis, Paper Roll, SF40A	30063920
Paper Roll, (1), Thermal, STP103	80251931
Paper Roll, (1), CBM910	80251932
Ink Ribbon, CBM910	80251933

Ramps

Accessories	Item No.
Foot Plate, Set(2), Painted, VE VN	72198344
Ramp, 48 in x 26.4 in long, Painted, VN	80252565
Ramp, 60 in x 26.4 in long, Painted, VN	80252566
Ramp, 60 in x 48 in, 2.5 K/5 K, VX	80252766
Ramp, 60 in x 48 in, 5 K, VX	80252767
Ramp, 60 in x 48 in, 10 K, VX	80252795
Ramp, 60 in x 48 in, 10 K, VX	80252796

Relay Kits

Accessories	Item No.
USB with I/O Kit, T72XW	30132164
Discrete I/O Kit, 2-In/4-Out, R71 TD52	30097591
Relay Kit, AC, T51 T71	80500720
Relay Kit, DC, T51 T71	80500727

Weighing & Measuring Accessories

Rechargeable Batteries

Accessories	Item No.
Rechargeable Battery, EX-HiCap R71	30041295
Rechargeable Battery Kit, T51 T71	80500729
Rechargeable Battery, NVL NVT	83032106
Battery Kit, Li-ion, TD52	30424405

Scoops

Accessories	Item No.
Scoop, 110 x 90 x 30 mm, Black	80250048
Scoop, Flat Bottomed, SST, 0.6 l	80250400
Scoop, Large, Flat Bottomed, SST	80250954
Scoop and Counter Weight	80780001
Scoop, PP, 0.8 l	80780006
Scoop and Counter Weight, Poly	80780014
Scoop and Counter Weight, SST	80780015
Scoop and Counter Weight, 1.75 l	80780016
Scoop, Small, Analytical	80850321
Scoop, Large, PAJ	80850322
Scoop, Poly, 0.6l	80850359
Scoop, Small, PAJ	80850364

Software

Accessories	Item No.
Software, Winwedge	80850080

Wall Mounts

Accessories	Item No.
Wall Mount Kit, Painted, T51P T71P	72200227
Wall Mount Kit, Painted, T31P	80251747
Wall Mount Kit, SST, T32XW	80251748
Wall Mount Kit, SST, T51XW T71XW	80500735
Wall Mount Kit, SST, TD52XW	30424026
Wall Mount Kit, CS, TD52P	30424027

Weight Accessories

Accessories	Item No.
Weight Set, Metric, 1119-D0	80780008
Forceps, 70 mm, 2-3/8 in.	80780009
Forceps, 3-3/8	80780010

Laboratory Equipment



OHAUS is now offering equipment designed for every area of the laboratory, giving you the opportunity to Do More. From stirrers to shakers, lifts to clamps, our newly expanded portfolio is filled with products perfect for life sciences laboratories, giving you countless opportunities to fill every inch of your laboratory.



Frontier™ 5000 Series Micro

Smooth and Dependable High-Speed Microliter Centrifuges for Life Science Separation Applications

- Quickly set speed, run time and temperature (R model only) with the easy to use touch wheel on the 5513 or rotary knob on 5515(R).
- A powerful brushless induction motor, 10 acceleration and deceleration ratings, and memory for up to 99 commonly-used parameters are a few of Frontier 5000 series micro features that propel high-performance.
- Equipped with a lid locking system and sensor that stops the centrifuge if the rotors become imbalanced, protecting the operator from being injured by the spinning rotors.



FC5513



FC5515R

- Application** Centrifugation
- Display** LCD, Backlight, 2 lines
- Operation** AC Power (Included)
- Construction** Brushless quiet motor, small footprint
- Design Features** High sample throughput, multi-safety control, personal program function

Model	Speed Range	Temp Range	Max g-force	Capacity	Weight	Dimensions (L x W x H)	Item No.
FC5513	200 rpm -13,500 rpm	Air Cooled	17,317 g	24 x 1.5/2.0 ml	28lb/12.5Kg	11.0 x 9.4 x 13.8 in (280 x 240 x 350 mm)	30393188
FC5515	200 rpm-15,200 rpm		21,953 g	12 x 5 ml; 4 x 8 place PCR Strips	37.4lb/17Kg	15.43 x 11.3 x 11.5" (392 x 287 x 292 mm)	30130867
FC5515R		-20° to 40°C			77lb/35Kg	21.85 x 11.3 x 11.5" (555 x 287 x 292 mm)	30130869

Accessories for FC5515 and FC5515R	Item No.
Rotor, Angle, 24 x 1.5/2.0 ml	30130870
Rotor, Angle, 24 x 1.5/2.0 ml, Sealable	30130871
Rotor, Angle, 30 x 1.5/2.0 ml, Sealable	30130872
Rotor, Angle, 12 x 5 ml, Sealable	30130873
Rotor, Angle, 4 x 8-Place PCR Stripes	30130874
Rotor, Hematocrit, 24x Capillaries	30130881
Rotor, Angle, 44x1.5/2.0ml, ID, v2	30372717

Accessories for FC5513	Item No.
Rotor, Angle, 24x1.5/2.0ml, Sealable, V2	30472302
Rotor, Angle, 18x2ml Spin Column	30472303
Rotor, Hematocrit, 24xCapillaries, V2	30472304
Adapter, 1x0.5 ml D8 mm, 6/pk	30130885
Adapter, 1x0.2/0.4 ml D6 mm, 6/pk	30130884
Rotor, Angle, 24x1.5/2.0ml, V2	30472301

Frontier™ 5000 Series Multi Pro

Powerful and Versatile Universal Centrifuges for Virtually Every Lab Application

- Our multi-purpose centrifuges offer a high-speed centrifugation platform which can be customized to fit workflow needs using a wide variety of rotors and accessories.
- The intuitive design of the centrifuges & accessories enable easy access to parameter settings, and quick rotation between applications.
- The performance of these centrifuges is propelled by German engineering, and high-quality components for reliable use.

Application Centrifugal Separation, General Sample Preparation, Cell Pelleting, Protein Separation, Nucleic Acid Separation, Cell Concentrating, Chemical Separation, Diagnostics, Environmental Sample Preparation, Blood Sample Processing

Display Backlit Liquid Crystal Display (LCD)

Operation Designed to be used with a variety of rotors and accessories

Construction Corrosion-resistant stainless steel chamber with Polycarbonate/ABS plastic lid

Design Features Ten acceleration & deceleration rates, selection of running time from 10 s to 99 h 59 min or continuous, quick spin, CFC-free refrigeration system, sample temp. indication (refrigerated models), lid-locking system, over-speed protection, dual imbalance sensing



Model	Speed Range	Temp Range	Max g-force	Capacity	Dimensions (L x W x H)	Item No.
FC5714	200 rpm–14,000 rpm	Air Cooled	18,624 g	4 × 100 ml	19.4 × 14.25 × 14.25" (14.25 × 362 × 362 mm)	30314811
FC5718	200 rpm–18,000 rpm	Air Cooled	23,542 g		19.65 × 16.06 × 13.82" (499 × 408 × 351 mm)	30314813
FC5718R		-20° to 40°C			28.78 × 16.02 × 14.13" (731 × 407 × 359 mm)	30314815
FC5816	200 rpm–15,000 rpm	Air Cooled	21,379 g	6 × 250 ml	21.18 × 21.18 × 13.94" (538 × 446 × 354 mm)	30314817
FC5816R	200 rpm–16,000 rpm	-20° to 40°C	24,325 g		21.18 × 28.46 × 28.46" (28.46 × 723 × 354 mm)	30314819

Accessories	Item No.
Rotor, Angle, 24 × 1.5/2.0 ml, ID, Sealable	30304361
Rotor, Swing out, 4 × 250 ml, ID	30314820
Rotor, Angle, 6 × 250 ml FB, ID	30314821
Rotor, Swing out, 4 × 100 ml, ID	30314822
Rotor, Swing out, 4 × 100 ml, ID, Sealable	30314823
Rotor, Swing out, 2 × 3MTP, ID	30314824
Rotor, Angle, 6 × 85 ml RB, ID, Hi	30314825
Rotor, Angle, 6 × 85 ml RB, ID	30314826
Rotor, Angle, 4 × 85 ml RB, ID, Hi	30314827
Rotor, Swing out, 16 × 50 ml, ID	30314828
Rotor, Angle, 10 × 50 ml FA, ID	30314829

Accessories	Item No.
Rotor, Angle, 6 × 50 ml RB/FA, ID	30314830
Rotor, Angle, 6 × 50 ml RB, ID, Hi	30314831
Rotor, Angle, 30 × 15 ml RB/FA, ID	30314832
Rotor, Angle, 20 × 10 ml RB, ID, Hi	30314833
Rotor, Angle, 12 × 15 ml RB/FA, ID	30314834
Rotor, Angle, 44x1.5/2.0ml, ID, v2	30372718
Rotor, Angle, 30 × 1.5/2.0 ml, ID, Sealable	30314836
Rotor, Angle, 24 × 1.5/2.0 ml, ID	30314838
Rotor, Angle, 12 × 1.5/2.0 ml, ID	30314839
Rotor, Angle, 64 × 0.5 ml, ID	30314840
Rotor, Angle, 4 × 8-w PCR Strip, ID	30314841

Frontier™ 5000 Series Multi

Reliable and Compact Multi-Function Centrifuges For Standard Life Science Separation Applications

- Programming speed and time is made simple with the touch wheel dial on the FC5707 or easy to turn control knob on the FC5706.
- Frontier 5707 accommodates 8 x 15ml round bottom or 4 x 15ml conical tubes, while 5706 handles 1.5 mL to 50 mL and can hold 6 x 50 mL tubes or 12 x 15 mL tubes during one process, providing centrifugation for a wide variety of applications.
- Frontier Series Multi has a lid locking system and sensor that stops the centrifuge if the rotors become imbalanced, protecting the operator from being injured by the spinning rotors.

Application	Centrifugation
Display	LCD, Backlight, 2 lines
Operation	AC Power (Included)
Construction	Brushless quiet motor, small footprint
Design Features	Easy installation design



FC5707



FC5706



Model	Speed Range	Max g-force	Capacity	Dimensions (L x W x H)	Weight	Item No.
FC5706 120V	200 rpm–6,000 rpm	4,427 g	6 × 50 ml	15.4 x 11.5 x 10.5" (392 x 291 x 266 mm)	23lbs/10.5Kg	30130876
FC5707 100-230V*	200 rpm -6,800 rpm	4,445 g	8x15ml RB/ 4x15ml FA	11.0 x 9.4 x 13.8 in (280 x 240 x 350 mm)	18lb/8Kg	30393189

*Includes Rotor, Angle, 8x15ml

Accessories for FC5706	Item No.
Angle Rotor, 6x50 mL	30130878
30 mL Tube Adapter, 2/pk	30130891
16 mL Tube Adapter, 2/pk	30130892
15 mL Tube Adapter, 2/pk	30130893
15 mL RB/ Falcon Tube Adapter, 2/pk	30130894
Angle Rotor, 12 × 15 mL	30130877
7mL Tube Adapter, 2/pk	30130889
5ml Tube Adapter, 2/pk	30130890
1.5 mL/2.0 mL Tube Adapter, 6/pk	30130886
Swing Out Rotor, 6 × 5 mL*	30130880
Replaceable Buckets, For Swing Out Rotor, 2/pk	30130895

Accessories for FC5707	Item No.
Rotor, Angle, 8x15ml	30472305
Adapter, D11mm, 1.5/2.0ml Tubes x6	30130886
Adapter, D13.5mm, 7ml Tubes x2	30130889
Adapter, D13.5mm, 5ml Tubes x2	30130890

*Includes 6 buckets

Frontier™ 5000 Series Mini

Powerful and Convenient Mini Centrifuge for Simple and Quick Life Science Separation Applications

- With a low voltage power input, quiet brushless motor and a rubber base that absorbs vibrations, Frontier 5306 minimizes operational noise and reduces disruptions in the laboratory.
- Frontier 5306 is designed with operator safety in mind, and includes a rotor imbalance sensor and two safety switches which immediately stop the rotors should the lid open during use.
- Frontier 5306 takes simple one-step operation to a new level. Simply place your sample in the centrifuge, close the lid, and it will begin to rotate without the press of a button for reliable use.



Two rotors and adapters are included

Application	Sample preparation
Operation	AC adapter (included)
Construction	Brushless quiet motor, auto shut-off safety switches
Design Features	One-touch operation

Model	Maximum Speed	Max g-force	Capacity	Dimensions (L x W x H)	Item No.
FC5306	6,000 rpm	2,000 g	8 × 1.5 ml / 2.0 ml; 4 × 8 place PCR Strips	6.6 x 5.9 x 5" (168 x 150 x 128 mm)	30134157

Accessories	Item No.
Adapter for 0.2 ml Tube (8PCS/Package)	30129561
Adapter for 0.5 ml Tube (8PCS/Package)	30129562

Frontier™ 5000 Rotors

Offering Flexibility to Maximize Sample Preparation

- Choose from a range of rotors to be used with Frontier centrifuges to match capacities and flexibility required for your basic to high-performance sample preparation needs.
- Designed with usability in mind, the Frontier rotors can be effortlessly installed or removed in a few quick and simple steps, and users have easy access to the samples.
- The sturdy rotors are constructed of high-quality materials, built to last through demanding workflows from autoclave sterilization to sub-zero temperature.



Application Centrifugation Accessory

Construction Aluminum or polypropylene material

Model	Rotor Style	Capacity	Max g-force	Maximum Speed	Item No.	
R-A8 × 2/6M	Angle	8 × 1.5 / 2.0 ml	2,560 g	6,000 rpm	30129559	
R-A4 × PCR/6		4 × 0.2 ml PCR8	2,260 g		30129560	
R-A24 × 2/15M		24 × 1.5 / 2.0 ml	21,953 g	15,200 rpm	30130870	
R-A24 × 2/15MS					30130871	
R-A30 × 2/13MS		30 × 1.5 / 2.0 ml	19,150 g	13,500 rpm	30130872	
R-A12 × 5/14MS		12 × 5 ml	19,978 g	14,500 rpm	30130873	
R-A4 × PCR/15		4 × 0.2 ml PCR8	15,342 g	15,000 rpm	30130874	
R-A12 × 15/6M		12 × 15 ml	4,427 g	6,000 rpm	30130877	
R-A6 × 50/6M		6 × 50 ml			30130878	
R-S6 × 5/4		Swing out	6 × 5 ml	1,817 g	4,000 rpm	30130880
R-A24 × CAP/12	Angle	24 × Capillaries	14,970 g	12,000 rpm	30130881	
R-A24 × 2/16MIS		24 × 1.5 / 2.0 ml	24,325 g	16,000 rpm	30304361	
R-S4 × 250/4MI	Swing out	4 × 250 ml	3,780 g	4,500 rpm	30314820	
R-A6 × 250/8MI	Angle	6 × 250 ml	10,016 g	8,000 rpm	30314821	
R-S4 × 100/4MI	Swing out	4 × 100 ml	3,350 g	4,500 rpm	30314822	
R-S4 × 100/5MIS			3,885 g	5,000 rpm	30314823	
R-S6 × MTP/4MI			2 × 3 MTP	2,716 g	4,500 rpm	30314824
R-A6 × 85/14MI	Angle	6 × 85 ml	20,984 g	13,500 rpm	30314825	
R-A6 × 85/13MI			21,726 g	13,000 rpm	30314826	
R-A4 × 85/12MI			14,809 g	12,000 rpm	30314827	
R-S16 × 50/4MI	Swing out	16 × 50 ml	3,735 g	4,500 rpm	30314828	
R-A10 × 50/10MI	Angle	10 × 50 ml	16,022 g	10,500 rpm	30314829	
R-A6 × 50/6MI		6 × 50 ml	4,427 g	6,000 rpm	30314830	
R-A6 × 50/13MI				15,869 g	13,000 rpm	30314831
R-A30 × 15/4MI				30 × 15 ml	2,830 g	4,500 rpm
R-A20 × 10/12MI		20 × 10 ml	15,775 g	12,000 rpm	30314833	
R-A12 × 15/6MI		12 × 15 ml	4,427 g	6,000 rpm	30314834	
R-A44 × 2/16MI		44 × 1.5 / 2.0 ml	24,325 g	16,000 rpm	30372718	
R-A30 × 2/14MIS		30 × 1.5 / 2.0 ml	20,595 g	14,000 rpm	30314836	
R-A24 × 2/16MI		24 × 1.5 / 2.0 ml	24,325 g	16,000 rpm	30314838	
R-A12 × 2/18MI		12 × 1.5 / 2.0 ml	23,542 g	18,000 rpm	30314839	
R-A64 × 0.5/13I		64 × 0.5 ml	16,298 g	13,500 rpm	30314840	
R-A4 × PCR/15I		4 × 8-w PCR Strip	15,343 g	15,000 rpm	30314841	

Multi Pro Centrifuge Rotors & Accessories

Frontier rotors extend the functionality of Frontier centrifuges by increasing the number of tubes of varied types and sizes that can be used in conjunction with each of the centrifuge models. Easy to clean and operate, the rotors are durably constructed to withstand demanding centrifugation.

Fixed Angle Rotor 24x1.5/2.0ml

Description	Item No.
Rotor, Angle, 24x1.5/2.0ml, ID, Sealable	30304361

Compatible to	FC5714	FC5718	FC5718R	FC5816	FC5816R
Max. Speed	14000 rpm	14000 rpm	15000 rpm	15000 rpm	16000 rpm
Max. RCF	18624 xg	18624 xg	21379 xg	21379 xg	24325 xg



Accessories	Vol./Tube	Diameter	Tube type	No.of tubes/rotor	Item No.	Price USD
Adapter, 1x0.5ml D8mm, 6/pk	0.5ml	8mm	Eppendorf tube	24	30130885	44
Adapter, 1x0.2/0.4ml D6mm, 6/pk	0.2/0.4ml	6mm	Eppendorf tube	24	30130884	44

Fixed Angle Rotor 6x250ml FB

Description	Item No.
Rotor, Angle, 6x250ml FB, ID	30314821

Compatible to	FC5714	FC5718	FC5718R	FC5816	FC5816R
Max. Speed	-	-	-	8000 rpm	8000 rpm
Max. RCF	-	-	-	10016 xg	10016 xg



Accessories	Vol./Tube	Diameter	Tube type	No.of tubes/rotor	Item No.
Adapter, 1x50ml D30mm FA, 2/pk	50ml	30mm	Conical bottom	6	30304374
Adapter, 1x50ml D29mm RB, 2/pk	50ml	29mm	Round bottom	6	30304373
Adapter, 2x30ml D26mm RB, 2/pk	30ml	26mm	Round bottom	12	30304372
Adapter, 4x15ml D17mm FA, 2/pk	15ml	17mm	Conical bottom	24	30304371
Adapter, 5x10ml D16mm RB, 2/pk	10ml	16mm	Round bottom	30	30304370
Adapter, 8x1.5ml D11mm, 2/pk	1.5ml	11mm	Eppendorf tube	48	30304369

Multi Pro Centrifuge Rotors & Accessories

Fixed Angle Rotor 6x85ml RB

Description	Item No.
Rotor, Angle, 6x85ml RB, ID, Hi	30314825

Compatible to	FC5714	FC5718	FC5718R	FC5816	FC5816R
Max. Speed	-	11000 rpm	13500 rpm	-	-
Max. RCF	-	13932 xg	20984 xg	-	-



Accessories	Vol./Tube	Diameter	Tube type	No.of tubes/rotor	Item No.
Adapter, 1x50ml D29mm RB, 2/pk, v2	50ml	29mm	Round bottom	6	30314895
Adapter, 1x50ml D29mm FA, 2/pk	50ml	29mm	Conical bottom	6	30314896
Adapter, 1x30ml D25mm RB, 2/pk	30ml	25mm	Round bottom	6	30314894
Adapter, 1x16ml D18mm RB, 2/pk	16ml	18mm	Round bottom	6	30314899
Adapter, 1x15ml D17mm FA, 2/pk	15ml	17mm	Conical bottom	6	30314897
Adapter, 2x15ml D17mm RB, 2/pk	15ml	17mm	Round bottom	12	30314898
Adapter, 1x15ml D17mm RB, 2/pk	15ml	17mm	Round bottom	6	30314893

Fixed Angle Rotor 6x85ml RB

Description	Item No.
Rotor, Angle, 6x85ml RB, ID	30314826

Compatible to	FC5714	FC5718	FC5718R	FC5816	FC5816R
Max. Speed	-	9000 rpm	9000 rpm	11000 rpm	13000 rpm
Max. RCF	-	10413 xg	10413 xg	15555 xg	21726 xg



Accessories	Vol./Tube	Diameter	Tube type	No.of tubes/rotor	Item No.
Adapter, 1x50ml D29mm RB, 2/pk, v2	50ml	29mm	Round bottom	6	30314895
Adapter, 1x50ml D29mm FA, 2/pk	50ml	29mm	Conical bottom	6	30314896
Adapter, 1x30ml D25mm RB, 2/pk	30ml	25mm	Round bottom	6	30314894
Adapter, 1x16ml D18mm RB, 2/pk	16ml	18mm	Round bottom	6	30314899
Adapter, 1x15ml D17mm FA, 2/pk	15ml	17mm	Conical bottom	6	30314897
Adapter, 2x15ml D17mm RB, 2/pk	15ml	17mm	Round bottom	12	30314898
Adapter, 1x15ml D17mm RB, 2/pk	15ml	17mm	Round bottom	6	30314893

Multi Pro Centrifuge Rotors & Accessories

Fixed Angle Rotor 4x85ml RB

Description	Item No.
Rotor, Angle, 4x85ml RB, ID, Hi	30314827

Compatible to	FC5714	FC5718	FC5718R	FC5816	FC5816R
Max. Speed	-	12000 rpm	12000 rpm	12000 rpm	12000 rpm
Max. RCF	-	14809 xg	14809 xg	14809 xg	14809 xg



Accessories	Vol./Tube	Diameter	Tube type	No.of tubes/rotor	Item No.
Adapter, 1x50ml D29mm RB, 2/pk, v2	50ml	29mm	Round bottom	4	30314895
Adapter, 1x50ml D29mm FA, 2/pk	50ml	29mm	Conical bottom	4	30314896
Adapter, 1x30ml D25mm RB, 2/pk	30ml	25mm	Round bottom	4	30314894
Adapter, 1x16ml D18mm RB, 2/pk	16ml	18mm	Round bottom	4	30314899
Adapter, 1x15ml D17mm FA, 2/pk	15ml	17mm	Conical bottom	4	30314897
Adapter, 2x15ml D17mm RB, 2/pk	15ml	17mm	Round bottom	8	30314898
Adapter, 1x15ml D17mm RB, 2/pk	15ml	17mm	Round bottom	4	30314893

Fixed Angle Rotor 10x50ml FA

Description	Item No.
Rotor, Angle, 10x50ml FA, ID	30314829

Compatible to	FC5714	FC5718	FC5718R	FC5816	FC5816R
Max. Speed	-	7500 rpm	7500 rpm	9000 rpm	10500 rpm
Max. RCF	-	8174 xg	8174 xg	11771 xg	16022 xg



Accessories	Vol./Tube	Diameter	Tube type	No.of tubes/rotor	Item No.
Adapter, 1x15ml D17mm RB, 2/pk, v2	15ml	17mm	Round bottom	10	30130894
Adapter, 1x7ml D13.5mm RB, 2/pk	7ml	13.5mm	Round bottom	10	30130889
Adapter, 1x5ml D13.5mm, 2/pk	5ml	13.5mm	Round bottom	10	30130890
Adapter, 1x1.5/2.0ml D11mm, 6/pk	1.5/2.0ml	11mm	Eppendorf tube	10	30130886

Multi Pro Centrifuge Rotors & Accessories

Fixed Angle Rotor 6x50ml RB/FA

Description	Item No.
Rotor, Angle, 6x50ml RB/FA, ID	30314830



Compatible to	FC5714	FC5718	FC5718R	FC5816	FC5816R
Max. Speed	6000 rpm	6000 rpm	6000 rpm	-	-
Max. RCF	4427 xg	4427 xg	4427 xg	-	-

Accessories	Vol./Tube	Diameter	Tube type	No.of tubes/rotor	Item No.
Adapter, 1x30ml D26mm, 2/pk	30ml	26mm	Round bottom	6	30130891
Adapter, 1x16ml D18mm, 2/pk	16ml	18mm	Round bottom	6	30130892
Adapter, 1x15ml D17mm, 2/pk	15ml	17mm	Round bottom	6	30130893
Adapter, 1x15ml D17mm RB, 2/pk, v2	15ml	17mm	Round/Conical bottom	6	30130894
Adapter, 1x7ml D13.5mm RB, 2/pk	7ml	13.5mm	Round bottom	6	30130889
Adapter, 1x5ml D13.5mm, 2/pk	5ml	13.5mm	Round bottom	6	30130890
Adapter, 1x1.5/2.0ml D11mm, 6/pk	1.5/2.0ml	11mm	Eppendorf tube	6	30130886

Fixed Angle Rotor 6x50ml RB

Description	Item No.
Rotor, Angle, 6x50ml RB, ID, Hi	30314831



Compatible to	FC5714	FC5718	FC5718R	FC5816	FC5816R
Max. Speed	-	12000 rpm	12000 rpm	13000 rpm	13000 rpm
Max. RCF	-	13522 xg	13522 xg	15869 xg	15869 xg

Accessories	Vol./Tube	Diameter	Tube type	No.of tubes/rotor	Item No.
Adapter, 1x30ml D26mm, 2/pk	30ml	26mm	Round bottom	6	30130891
Adapter, 1x16ml D18mm, 2/pk	16ml	18mm	Round bottom	6	30130892
Adapter, 1x15ml D17.5mm FA, 2/pk	15ml	17.5mm	Conical bottom	6	30314892
Adapter, 1x15ml D17mm, 2/pk	15ml	17mm	Round bottom	6	30130893

Multi Pro Centrifuge Rotors & Accessories

Fixed Angle Rotor 30x15ml RB/FA

Description	Item No.
Rotor, Angle, 30x15ml RB/FA, ID	30314832

Compatible to	FC5714	FC5718	FC5718R	FC5816	FC5816R
Max. Speed	4500 rpm	4500 rpm	4500 rpm	4500 rpm	4500 rpm
Max. RCF	2830 xg	2830 xg	2830 xg	2830 xg	2830 xg



Accessories	Vol./Tube	Diameter	Tube type	No.of tubes/rotor	Item No.
Adapter, 1x7ml D13.5mm RB, 2/pk	7ml	13.5mm	Round bottom	30	30130889
Adapter, 1x5ml D13.5mm, 2/pk	5ml	13.5mm	Round bottom	30	30130890
Adapter, 1x1.5/2.0ml D11mm, 6/pk	1.5/2.0ml	11mm	Eppendorf tube	30	30130886

Fixed Angle Rotor 20x10ml RB

Description	Item No.
Rotor, Angle, 20x10ml RB, ID, Hi	30314833

Compatible to	FC5714	FC5718	FC5718R	FC5816	FC5816R
Max. Speed	-	12000 rpm	12000 rpm	12000 rpm	12000 rpm
Max. RCF	-	15775 xg	15775 xg	15775 xg	15775 xg



Fixed Angle Rotor 12x15ml RB/FA

Description	Item No.
Rotor, Angle, 12x15ml RB/FA, ID	30314834

Compatible to	FC5714	FC5718	FC5718R	FC5816	FC5816R
Max. Speed	6000 rpm	6000 rpm	6000 rpm	-	-
Max. RCF	4427 xg	4427 xg	4427 xg	-	-



Accessories	Vol./Tube	Diameter	Tube type	No.of tubes/rotor	Item No.
Adapter, 1x7ml D13.5mm RB, 2/pk	7ml	13.5mm	Round bottom	12	30130889
Adapter, 1x5ml D13.5mm, 2/pk	5ml	13.5mm	Round bottom	12	30130890
Adapter, 1x1.5/2.0ml D11mm, 6/pk	1.5/2.0ml	11mm	Eppendorf tube	12	30130886

Multi Pro Centrifuge Rotors & Accessories

Fixed Angle Rotor 44x1.5/2.0ml

Description	Item No.
Rotor, Angle, 44x1.5/2.0ml, ID	30314835



Compatible to	FC5714	FC5718	FC5718R	FC5816	FC5816R
Max. Speed	-	13500 rpm	13500 rpm	15000 rpm	16000 rpm
Max. RCF	-	17113 xg	17113 xg	21128 xg	24039 xg

Accessories	Vol./Tube	Diameter	Tube type	No.of tubes/rotor	Item No.
Adapter, 1x0.5ml D8mm, 6/pk	0.5ml	8mm	Eppendorf tube	44	30130885
Adapter, 1x0.2/0.4ml D6mm, 6/pk	0.2/0.4ml	6mm	Eppendorf tube	44	30130884

Fixed Angle Rotor 30x1.5/2.0ml

Description	Item No.
Rotor, Angle, 30x1.5/2.0ml, ID, Sealable	30314836



Compatible to	FC5714	FC5718	FC5718R	FC5816	FC5816R
Max. Speed	12000 rpm	13000 rpm	14000 rpm	-	-
Max. RCF	15131 xg	17758 xg	20595 xg	-	-

Accessories	Vol./Tube	Diameter	Tube type	No.of tubes/rotor	Item No.
Adapter, 1x0.5ml D8mm, 6/pk	0.5ml	8mm	Eppendorf tube	30	30130885
Adapter, 1x0.2/0.4ml D6mm, 6/pk	0.2/0.4ml	6mm	Eppendorf tube	30	30130884

Fixed Angle Rotor 24x1.5/2.0ml

Description	Item No.
Rotor, Angle, 24x1.5/2.0ml, ID	30314838



Compatible to	FC5714	FC5718	FC5718R	FC5816	FC5816R
Max. Speed	14000 rpm	14000 rpm	15000 rpm	15000 rpm	16000 rpm
Max. RCF	18624 xg	18624 xg	21379 xg	21379 xg	24325 xg

Accessories	Vol./Tube	Diameter	Tube type	No.of tubes/rotor	Item No.
Adapter, 1x0.5ml D8mm, 6/pk	0.5ml	8mm	Eppendorf tube	24	30130885
Adapter, 1x0.2/0.4ml D6mm, 6/pk	0.2/0.4ml	6mm	Eppendorf tube	24	30130884

Multi Pro Centrifuge Rotors & Accessories

Fixed Angle Rotor 12x1.5/2.0ml

Description	Item No.
Rotor, Angle, 12x1.5/2.0ml, ID	30314839

Compatible to	FC5714	FC5718	FC5718R	FC5816	FC5816R
Max. Speed	-	18000 rpm	18000 rpm	-	-
Max. RCF	-	23542 xg	23542 xg	-	-



Accessories	Vol./Tube	Diameter	Tube type	No.of tubes/rotor	Item No.
Adapter, 1x1.5ml for over16000xg, 6/pk	1.5ml	11mm	Eppendorf tube	12	30314900
Adapter, 1x0.5ml D8mm, 6/pk	0.5ml	8mm	Eppendorf tube	12	30130885
Adapter, 1x0.2/0.4ml D6mm, 6/pk	0.2/0.4ml	6mm	Eppendorf tube	12	30130884

Fixed Angle Rotor 64x0.5ml

Description	Item No.
Rotor, Angle, 64x0.5ml, ID	30314840

Compatible to	FC5714	FC5718	FC5718R	FC5816	FC5816R
Max. Speed	-	13500 rpm	13500 rpm	-	-
Max. RCF	-	16298 xg	16298 xg	-	-



Fixed Angle Rotor 4x8-w PCR Strip

Description	Item No.
Rotor, Angle, 4x8-w PCR Strip, ID	30314841

Compatible to	FC5714	FC5718	FC5718R	FC5816	FC5816R
Max. Speed	-	15000 rpm	15000 rpm	-	-
Max. RCF	-	15343 xg	15343 xg	-	-



Multi Pro Centrifuge Rotors & Accessories

Swing Out Rotors 4x250ml

Description	Item No.
Rotor, Swing out, 4x250ml, ID	30314820



Compatible to	FC5714	FC5718	FC5718R	FC5816	FC5816R
Max. Speed	-	-	-	4500 rpm	4500 rpm
Max. RCF	-	-	-	3780 xg	3780 xg

Accessories	Vol./Tube	Diameter	Tube type	No.of tubes/rotor	Item No.
Screw Cap, Rack of 250ml Rotor, 2/pk	-	-	-	-	30314901
O-ring, Rack of 250ml Rotor, 10/pk	-	-	-	-	30314902
Rack, 1x250ml D62mm FB, 2/pk	250ml	62mm	Flat bottom	4	30314903
Rack, 1x100ml D41mm RB, 2/pk	100ml	41mm	Round bottom	4	30314904
Rack, 1x50ml D34mm RB, 2/pk, v3	50ml	34mm	Round bottom	4	30314907
Rack, 3x50ml D29mm RB, 2/pk	50ml	29mm	Round bottom	12	30314905
Rack, 3x50ml D29mm FA, 2/pk	50ml	29mm	Conical bottom	12	30314906
Rack, 2x50ml D29mm Rim, 2/pk	50ml	29mm	Skirted conical bottom	8	30314908
Rack, 1x50ml D29mm Rim, 2/pk, v3	50ml	29mm	Skirted conical bottom	4	30314909
Rack, 5x25ml D24.5mm RB, 2/pk	25ml	24.5mm	Round bottom	20	30314910
Rack, 3x25ml D24.5mm Rim, 2/pk	25ml	24.5mm	Skirted conical bottom	12	30314911
Rack, 9x15ml D17mm RB, 2/pk	15ml	17mm	Round bottom	36	30314912
Rack, 7x15ml D17mm FA, 2/pk	15ml	17mm	Conical bottom	28	30314913
Rack, 7x15ml D17mm Rim, 2/pk	15ml	17mm	Skirted conical bottom	28	30314914
Rack, 8x10ml D16mm RB, 2/pk	10ml	16mm	Round bottom	32	30314915
Rack, 8x4-10ml D16mm Vac, 2/pk	4-10ml	16mm	Vacutainer	32	30304367
Rack, 14x5-7ml D13mm RB, 2/pk	5-7ml	13mm	Round bottom	56	30314916
Rack, 10x1.6-7ml D13mm Vac, 2/pk	1.6-7ml	13mm	Vacutainer	40	30314917
Adapter, 9x1.5/2.0ml D11mm, 2/pk	1.5/2.0ml	11mm	Eppendorf tube	36	30304368

Multi Pro Centrifuge Rotors & Accessories

Swing Out Rotor 4x100ml

Description	Item No.
Rotor, Swing out, 4x100ml, ID	30314822

Compatible to	FC5714	FC5718	FC5718R	FC5816	FC5816R
Max. Speed	4500 rpm	4500 rpm	4500 rpm	-	-
Max. RCF	3350 xg	3350 xg	3350 xg	-	-



Accessories	Vol./Tube	Diameter	Tube type	No.of tubes/rotor	Item No.
Rack, 1x100ml D46mm RB, 2/pk	100ml	46mm	Round bottom	4	30314842
Rack, 1x85ml D38mm RB, 2/pk	85ml	38mm	Round bottom	4	30314843
Rack, 1x50ml D34mm RB, 2/pk	50ml	34mm	Round bottom	4	30314844
Rack, 1x50ml D29mm RB, 2/pk	50ml	29mm	Round bottom	4	30314845
Rack, 1x50ml D29mm FA, 2/pk	50ml	29mm	Conical bottom	4	30314846
Rack, 1x50ml D29mm Rim, 2/pk	50ml	29mm	Skirted conical bottom	4	30314847
Rack, 1x30ml D25mm Rim, 2/pk	30ml	25mm	Skirted conical bottom	4	30314848
Rack, 1x25ml D25mm RB, 2/pk	25ml	25mm	Round bottom	4	30314849
Rack, 7x15ml D17mm RB, 2/pk	15ml	17mm	Round bottom	28	30314852
Rack, 2x15ml D17mm FA, 2/pk	15ml	17mm	Conical bottom	8	30314850
Rack, 1x15ml D17mm Rim, 2/pk	15ml	17mm	Skirted conical bottom	4	30314851
Rack, 5x4-10ml D16mm Sar, 2/pk	4-10ml	16mm	Sarstedt	20	30314858
Rack, 9x5-7ml D13mm RB, 2/pk	5-7ml	13mm	Round bottom	36	30314853
Rack, 7x5-7ml D13mm RB, 2/pk	5-7ml	13mm	Round bottom	28	30314856
Rack, 7x5-7ml D13mm Vac, 2/pk	5-7ml	13mm	Vacutainer	28	30314857
Rack, 10x1.5ml D11mm, 2/pk	1.5ml	11mm	Eppendorf tube	40	30314854
Rack, 9x4.5ml D12mm FB, 2/pk	4.5ml	12mm	Flat bottom	36	30314855

Multi Pro Centrifuge Rotors & Accessories

Swing Out Rotors 4x100ml

Description	Item No.
Rotor, Swing out, 4x100ml, ID, Sealable	30314823



Compatible to	FC5714	FC5718	FC5718R	FC5816	FC5816R
Max. Speed	4000 rpm	5000 rpm	5000 rpm	-	-
Max. RCF	2486 xg	3885 xg	3885 xg	-	-

Accessories	Vol./Tube	Diameter	Tube type	No.of tubes/rotor	Item No.
Bucket, 100ml w/o Cap, 2/pk	-	-	-	-	30314860
Bucket, 100ml w/ Cap, Sealable, 2/pk	-	-	-	-	30314861
Screw Cap, 100ml Bucket, Sealable, 2/pk	-	-	-	-	30314862
O-ring, 100ml Bucket, Sealable, 10/pk	-	-	-	-	30314863
Rack, 1x100ml D40mm RB, 2/pk	100ml	40mm	Round bottom	4	30314864
Rack, 1x85ml D38mm RB, 2/pk, v2	85ml	38mm	Round bottom	4	30314865
Rack, 1x50ml D34mm RB, 2/pk, v2	50ml	34mm	Round bottom	4	30314866
Rack, 1x50ml D29mm RB, 2/pk, v2	50ml	29mm	Round bottom	4	30314867
Rack, 1x50ml D29mm FA, 2/pk, v2	50ml	29mm	Conical bottom	4	30314868
Bucket, 2x50ml D29mm FA, w/ Rack, 2/pk	50ml	29mm	Conical bottom	8	30314881
Rack, 1x50ml D29mm Rim, 2/pk, v2	50ml	29mm	Skirted conical bottom	4	30314869
Rack, 1x30ml D25mm Rim, 2/pk, v2	30ml	25mm	Skirted conical bottom	4	30314870
Rack, 1x25ml D25mm RB, 2/pk, v2	25ml	25mm	Round bottom	4	30314871
Rack, 1x15ml D17mm FA, 2/pk	15ml	17mm	Conical bottom	4	30314872
Rack, 2x15ml D17mm FA, 2/pk, v2	15ml	17mm	Conical bottom	8	30314873
Rack, 2x15ml D17mm Rim, 2/pk	15ml	17mm	Skirted conical bottom	8	30314874
Rack, 4x15ml D17mm RB, 2/pk	15ml	17mm	Round bottom	16	30314875
Bucket, 3x15ml D17mm FA, w/ Rack, 2/pk	15ml	17mm	Conical bottom	12	30314882
Rack, 3x10ml D17mm Sar, 2/pk	10ml	17mm	Sarstedt	12	30314878
Rack, 4x10ml D17mm Vac, 2/pk	10ml	17mm	Vacutainer	16	30314880
Rack, 7x5-7ml D13mm RB, 2/pk, v2	5-7ml	13mm	Round bottom	28	30314876
Rack, 4x5-7ml D13mm RB, 2/pk	5-7ml	13mm	Round bottom	16	30314879
Rack, 5x1.5ml D11mm, 2/pk	1.5ml	11mm	Eppendorf tube	20	30314877

Multi Pro Centrifuge Rotors & Accessories

Swing Out Rotors 2x3MTP

Description	Item No.
Rotor, Swing out, 2x3MTP, ID	30314824

Compatible to	FC5714	FC5718	FC5718R	FC5816	FC5816R
Max. Speed	4500 rpm	4500 rpm	4500 rpm	4500 rpm	4500 rpm
Max. RCF	2716 xg	2716 xg	2716 xg	2716 xg	2716 xg



Accessories	Vol./Tube	Diameter	Tube type	No.of tubes/rotor	Item No.
Bucket, 3xMTP, 2/pk	MTP	–	–	6	30314890
Adapter, 48x1.5/2.0ml D11mm, 2/pk	1.5/2.0ml	11mm	Eppendorf tube	96	30314891

Swing Out Rotors 16x50ml

Description	Item No.
Rotor, Swing out, 16x50ml, ID	30314828

Compatible to	FC5714	FC5718	FC5718R	FC5816	FC5816R
Max. Speed	–	–	–	4500 rpm	4500 rpm
Max. RCF	–	–	–	3735 xg	3735 xg



Accessories	Vol./Tube	Diameter	Tube type	No.of tubes/rotor	Item No.
Rack, 4x50ml D29mm FA, 2/pk	50ml	29mm	Conical bottom	16	30304375
Rack, 10x15ml D17mm FA, 2/pk	15ml	17mm	Conical bottom	40	30314583
Rack, 12x4-10ml D16mm Vac/Sar, 2/pk	4-10ml	16mm	Vacutainer/Sarstedt	48	30314585
Rack, 14x5-7ml D13mm Vac/Sar, 2/pk	5-7ml	13mm	Vacutainer/Sarstedt	56	30314584

Open Air Shakers Selector Guide



Product Family	Light Duty Orbital Shaker	Light Duty Orbital Shaker	Light Duty Orbital Shaker	Light Duty Orbital Shaker
Model	SHLD0415AL	SHLD0403DG	SHLD0415DG	SHLDMP03DG
Speed Range	40 to 300 rpm	100 to 1200 rpm	40 to 300 rpm	100 to 1200 rpm
Timer	N/A	1 second to 160 hours	1 second to 160 hours	1 second to 160 hours
Motion	Orbital	Orbital	Orbital	Orbital
Orbit	15 mm	3 mm	15 mm	3 mm
Max Weight Capacity	8 lbs	8 lbs	8 lbs	4 microplates / 2 micro-tube racks
Audible Alarm	—	●	●	●
Load Sensor	—	—	—	—
Motor Type	Brushless DC Motor	Brushless DC Motor	Brushless DC Motor	Brushless DC Motor
CO ₂ Environment	●	●	●	●
Overload Protection	—	●	●	●
User Calibration (Speed)	—	—	—	—
RS232 Interface	—	—	—	—
Included Tray (L x W)	11.75 x 8.75"	11.75 x 8.75"	11.75 x 8.75"	11 x 7.75"
Tray / Platform Options (L x W)	N/A	Adjustable Platform	Adjustable Platform	N/A



Product Family	Extreme Environment Shakers	Heavy Duty Shaker	Heavy Duty Shaker	Heavy Duty Shaker
Model	SHEX1619DG	SHHD1619AL	SHHD1619DG	SHHD2325AL
Speed Range	15 to 500 rpm	25 to 500 rpm	15 to 500 rpm	25 to 500 rpm
Timer	1 second to 160 hours	1 to 120 minutes	1 second to 160 hours	1 to 120 minutes
Motion	Orbital	Orbital	Orbital	Orbital
Orbit	19 mm	19 mm	19 mm	25 mm
Max Weight Capacity	35 lbs	35 lbs	35 lbs	50 lbs
Audible Alarm	●	—	●	—
Load Sensor	●	—	●	—
Motor Type	Brushless DC Motor	Brushless DC Motor	Brushless DC Motor	Brushless DC Motor
CO ₂ Environment	●	●	●	●
Overload Protection	●	—	●	—
User Calibration (Speed)	●	—	●	—
RS232 Interface	●	—	●	—
Included Tray (L x W)	11 x 13"	11 x 13"	11 x 13"	18 x 24"
Tray / Platform Options (L x W)	11 x 13", 13 x 13", 18 x 18", 18 x 24" Adjustable Platform Separatory Funnel Platform	11 x 13", 13 x 13", 18 x 18", 18 x 24" Adjustable Platform Separatory Funnel Platform	11 x 13", 13 x 13", 18 x 18", 18 x 24" Adjustable Platform Separatory Funnel Platform	18 x 24", 18 x 30" Adjustable Platform Large Vessel Carrier Platform



Product Family	Heavy Duty Orbital Shaker	Heavy Duty Orbital Shaker	Heavy Duty Orbital Shaker	Heavy Duty Orbital Shaker	Heavy Duty Orbital Shaker
Model	SHHD2325DG	SHHD4525DG	SHHD4550DG	SHHD6825DG	SHHD6850DG
Speed Range	20 to 500 rpm	15 to 500 rpm	15 to 300 rpm	15 to 500 rpm	15 to 300 rpm
Timer	1 second to 160 hours	1 second to 160 hours	1 second to 160 hours	1 second to 160 hours	1 second to 160 hours
Motion	Orbital	Orbital	Orbital	Orbital	Orbital
Orbit	25 mm	25 mm	51 mm	25 mm	51 mm
Max Weight Capacity	50 lbs	100 lbs	100 lbs	150 lbs	150 lbs
Audible Alarm	●	●	●	●	●
Load Sensor	●	●	●	●	●
Motor Type	Brushless DC Motor	Brushless DC Motor	Brushless DC Motor	Brushless DC Motor	Brushless DC Motor
CO ₂ Environment	●	●	●	●	●
Overload Protection	●	●	●	●	●
User Calibration (Speed)	●	●	●	●	●
RS232 Interface	●	●	●	●	●
Included Tray (L x W)	18 x 24"	24 x 24"	24 x 24"	24 x 36"	24 x 36"
Tray / Platform Options (L x W)	18 x 24", 18 x 30" Adjustable Platform Large Vessel Carrier Platform	24 x 24" Large Vessel Carrier Platform	24 x 24" Large Vessel Carrier Platform	24 x 36" Large Vessel Carrier Platform	24 x 36" Large Vessel Carrier Platform



Product Family	Rocking Shaker	Rocking Shaker	Waving Shaker	Waving Shaker	Reciprocating Shaker
Model	SHRK04DG	SHRK07AL1	SHWV02DG	SHWV02AL	SHRC0719DG
Speed Range	1 to 50 rpm*	1 to 75 rpm*	1 to 30 rpm*	1 to 75 rpm*	20 to 300 rpm
Timer	1 second to 160 hours	1 minute to 120 minutes	1 second to 160 hours	1 minute to 120 minutes	1 second to 160 hours
Motion	Rocking	Rocking	Waving	Waving	Reciprocating
Orbit	Tilt Angle: 0 to 15°	Tilt Angle: 0 to 15°	Tilt Angle: 0 to 20° *	Tilt Angle: 0 to 16°	Stroke: 19 mm
Max Weight Capacity	10 lbs**	16 lbs**	5 lbs**	5 lbs**	15 lbs
Audible Alarm	●	—	●	—	●
Load Sensor	—	—	—	—	●
Motor Type	Stepper Motor	Stepper Motor	Stepper Motor	Stepper Motor	Brushless DC Motor
CO ₂ Environment	●	—	●	—	●
Overload Protection	●	—	●	—	●
User Calibration (Speed)	—	—	—	—	●
RS232 Interface	—	—	—	—	●
Included Tray (L x W)	12.75 x 10"	14 x 11"	11.75 x 8.75"	14 x 11"	11 x 13"
Tray / Platform Options (L x W)	Stacking Tray	Stacking Tray	Stacking Tray	—	11 x 13", 13 x 13", 18 x 18", 18 x 24" Separatory Funnel Platform

● Yes * Maximum speed/tilt angle may vary with heavy or unbalanced loads. ** Centered on tray.

Light Duty Orbital Shakers

- Variable speed microprocessor control
- Low profile design
- 15 mm orbit

The OHAUS Light Duty Analog Shaker is an economical shaker designed for educational labs or basic shaking applications.



Operating Features:

Low Profile Design: Takes up less space and easily fits into most hoods and incubators.

Microprocessor Control: The variable speed microprocessor control provides consistent uniform shaking action.

Triple Eccentric Drive: Permanently lubricated ball bearings and maintenance free, brushless DC motor provide reliable service and continuous duty operation.

Adjustment Knob: Basic speed knob with dial settings from 1 to 10.

Safety Features:

Speed Ramping Feature: Slowly increases speed to desired set-point to avoid splashing.

Spill-Resistant Design: Channels fluids away from internal components.

Operating Conditions:

Unit can be run in cold rooms, incubators, and CO₂ environments from 0 to 40°C (32 to 104°F), maximum 80% relative humidity, non-condensing.

Applications:

Blotting techniques, staining/destaining, and general shaking procedures.

Ordering Information:

Units include a detachable, 3-wire cord and plug. Units are also supplied with an 11.75 × 8.75" (29.9 × 22.2 cm) non-skid rubber mat.

Model	Speed Range	Orbit	Maximum Weight Capacity	Tray Material	Tray Dimensions (L × W)	Item No.
SHLD0415AL	40 to 300 rpm	15 mm (0.6")	8 lbs (3.6 kg)	Aluminum	11.75 × 8.75" (29.9 × 22.2 cm)	30391891

Light Duty Orbital Shakers

- General purpose shaker
- LED displays for speed and time
- 3 mm or 15 mm orbit

The OHAUS Digital Light Duty Orbital Shaker is ideal for a wide variety of shaking applications. Tray includes a non-skid rubber mat. Remove the mat to mount a variety of optional flask clamps or test tube racks directly onto the tray.

Operating Features:

Low Profile Design: Takes up less space and easily fits into most hoods and incubators.

Microprocessor Control: The variable speed microprocessor control provides consistent uniform shaking action. Microprocessor will display last set-point and will restart if power is interrupted.

Triple Eccentric Drive: Permanently lubricated ball bearings and maintenance free, brushless DC motor provide reliable service and continuous duty operation.

LED Display: Touchpad controls with easy-to-read, independent LED displays for speed and time allow operator to view both settings at once. Provides repeatable and accurate results every time and is easily visible across lab benches. Timer will display elapsed time or, when programmed to user defined limit, will shut off unit when time reaches zero. Display will show last used settings, even after power has been turned off.

Safety Features:

Overload Protection: Audible and visual signals will activate when system detects an obstruction or overload of the tray.

Speed Ramping Feature: Slowly increases speed to desired set-point to avoid splashing.

Audible Alarm: In timed mode, alarm will sound when the time reaches zero.

Spill-Resistant Design: Channels fluids away from internal components.

Operating Conditions:

Units can be run in cold rooms, incubators, and CO₂ environments.

SHLD0403DG: -10 to 60°C (14 to 140°F)

SHLD0415DG: -10 to 40°C (14 to 104°F)

Maximum 80% relative humidity, non-condensing.

Applications:

Cell cultures, immunoassays, and protein studies.

Ordering Information:

Units include a detachable, 3-wire cord and plug. Units are also supplied with an 11.75 × 8.75" (29.9 × 22.2 cm) non-skid rubber mat.



Model	Speed Range	Speed Accuracy	Timer	Orbit	Maximum Weight Capacity	Tray Material	Tray Dimensions (L × W)	Item No.
SHLD0403DG	100 to 1200 rpm	+/-2% above 100 rpm	1 second to 160 hours	3 mm (0.12")	8 lbs (3.6 kg)	Aluminum	11.75 × 8.75" (29.9 × 22.2 cm)	30391898
SHLD0415DG	40 to 300 rpm	+/-2 rpm below 100 rpm	1 second to 160 hours	15 mm (0.6")	8 lbs (3.6 kg)	Aluminum	11.75 × 8.75" (29.9 × 22.2 cm)	30391912

Light Duty Orbital Shakers

- Holds up to 4 microplates or 2 micro-tube racks
- Accepts deep well plates
- Timer with audible alarm

The OHAUS Microplate Shaker is ideal for immunoassays and general microplate shaking, and is designed to be used in a variety of environmental conditions.



Operating Features:

Low Profile Design: Takes up less space and easily fits into most hoods and incubators. Base offers durability and added stability.

Microprocessor Control: The variable speed microprocessor control provides consistent uniform shaking action. Microprocessor will display last set-point and will restart if power is interrupted.

Triple Eccentric Drive: Permanently lubricated ball bearings and maintenance free, brushless DC motor provide reliable service and continuous duty operation.

LED Display: Touchpad controls with easy-to-read, independent LED displays for speed and time allow operator to view all settings at once. Provides repeatable and accurate results every time and is easily visible across lab benches. Timer will display elapsed time or, when programmed to user defined limit, will shut off unit when time reaches zero. Display will show last used settings, even after power has been turned off.

Safety Features:

Overload Protection: Audible and visual signals will activate when system detects an obstruction or overload of the tray.

Speed Ramping Feature: Slowly increases speed to desired set-point to avoid splashing.

Audible Alarm: In timed mode, alarm will sound when the time reaches zero.

Spill-Resistant Design: Channels fluids away from internal components.

Operating Conditions:

Unit can be run in cold rooms, incubators, and CO₂ environments from -10 to 60°C (14 to 140°F), maximum 80% relative humidity, non-condensing.

Applications:

ELISA assays and DNA studies.

Ordering Information:

Units include a detachable, 3-wire cord and plug.

Model	Speed Range	Speed Accuracy	Timer	Orbit	Maximum Weight Capacity	Tray Material	Tray Dimensions (L x W)	Item No.
SHLDMP03DG	100 to 1200 rpm	± 2%	1 second to 160 hours	3 mm (0.12")	4 microplates or 2 micro-tube racks	Aluminum	11 × 7.75" (27.9 × 19.7 cm)	30391905

Extreme Environment Shakers

- Designed for use in CO₂ Incubators
- Can withstand extreme environments up to 100% humidity
- Remote controller magnetically attaches to most incubators

The OHAUS Extreme Environment Orbital Shaker is designed for a wide range of applications including cell cultures that require CO₂ and humidity for optimal cell growth. The microprocessor control provides consistent uniform shaking while safely ramping to the set speed.

Operating Features:

Accu-Drive Shaking System: The exclusive patented Accu-Drive Shaking System delivers exceptional speed control, accuracy, and durability. The shaking system continuously monitors shaking speed and maintains set-point, even under changing loads. When unit is set to a speed above 100 rpm, the speed accuracy is $\pm 1\%$ of set speed. When set under 100 rpm, speed accuracy is ± 1 rpm.

Microprocessor Control: The variable speed microprocessor control provides consistent uniform shaking action. Microprocessor will display last set-point and will restart if power is interrupted.

Triple Eccentric Drive: Permanently lubricated ball bearings and maintenance free, brushless DC motor provide reliable service and continuous duty operation.

Remote Controller: The control module is designed to sit outside of the incubator. Settings can be easily viewed or changed from outside of the incubator without disturbing the incubator's atmosphere. The thin ribbon cable is 5.5 feet long and easily passes underneath an incubator door via incubator's utility port. Controller magnetically attaches to most incubator doors or can sit on a lab bench.

LED Display: Touchpad controls with easy-to-read, independent LED displays for speed and time allow operator to view both settings at once. Provides repeatable and accurate results every time and is easily visible across lab benches. Timer will display elapsed time or, when programmed to user defined limit, will shut off unit when time reaches zero. Display will show last used settings, even after power has been turned off.

RS232 Interface: Provides two-way communication for data logging and unit control.

Speed Calibration Mode: Allows user to automatically recalibrate speed display.

Safety Features:

Overload Protection: Audible and visual signals will activate when system detects an obstruction.

Speed Ramping Feature: Slowly increases speed to desired set-point to avoid splashing.

Audible Alarm: In timed mode, alarm will sound when the time reaches zero. Alarm has optional mute function which can be set from the Touchpad control.

Spill-Resistant Design: Channels fluids away from internal components.

Operating Conditions:

Unit can be run in cold rooms, incubators, and CO₂ environments from -10 to 60°C (14 to 140°F), up to 100% humidity.

Applications:

Cell cultures, solubility studies, and extraction procedures.

Ordering Information:

Unit includes a detachable, 3-wire cord and plug. Unit is also supplied with an 11 × 13" (27.9 × 33 cm) non-skid rubber mat.



Model	Speed Range	Speed Accuracy	Timer	Orbit	Maximum Weight Capacity	Tray Material	Tray Dimensions (L × W)	Item No.
SHEX1619DG	15 to 500 rpm	above 100 rpm $\pm 1\%$ of set speed below 100 rpm ± 1 rpm	1 second to 160 hours	0.75" (19 mm)	35 lbs (16 kg)	Aluminum	11 × 13" (27.9 × 33 cm)	30391809

Heavy Duty Orbital Shakers

- Microprocessor controls
- Continuous or timed operation
- 35 lb weight capacity

The OHAUS 16 kg Capacity Analog Heavy Duty Orbital Shaker is designed for a wide range of applications that require basic shaking control. Shaker provides reproducible motion that is evenly distributed throughout the entire surface of the tray.

Operating Features:

Microprocessor Control: The variable speed microprocessor control provides consistent uniform shaking action. The shaker will automatically restart after a power interruption.

Triple Eccentric Drive: Permanently lubricated ball bearings and maintenance free, brushless DC motor provide reliable service and continuous duty operation.

Adjustment Knobs: Basic speed and time knobs with dial settings from 1 to 10.

Safety Features:

Speed Ramping Feature: Slowly increases speed to desired set-point to avoid splashing.

Spill-Resistant Design: Channels fluids away from internal components.

Operating Conditions:

Unit can be run in cold rooms, incubators, and CO₂ environments from 0 to 40°C (32 to 104°F), maximum 80% relative humidity, non-condensing.

Applications:

Bacterial suspensions, staining/destaining, and general mixing.

Ordering Information:

Unit includes a detachable, 3-wire cord and plug. Unit is also supplied with an 11 × 13" (27.9 × 33 cm) non-skid rubber mat.



Model	Speed Range	Timer	Orbit	Maximum Weight Capacity	Tray Material	Tray Dimensions (L × W)	Item No.
SHHD1619AL	25 to 500 rpm	1 minute to 120 minutes	19 mm (0.75")	35 lbs (16 kg)	Aluminum	11 × 13" (27.9 × 33 cm)	30391307

Heavy Duty Orbital Shakers

- Exceptional speed control, accuracy and durability
- LED displays for speed and time
- Calibration mode for speed

The OHAUS 16 kg Capacity Digital Heavy Duty Orbital Shaker is designed for a wide range of applications, including cell cultures, that require accurate and repeatable results. The microprocessor control provides consistent uniform shaking while safely ramping to the set speed.



Operating Features:

Accu-Drive Shaking System: The exclusive patented Accu-Drive Shaking System delivers exceptional speed control, accuracy, and durability. The shaking system continuously monitors shaking speed and maintains set-point, even under changing loads. When unit is set to a speed above 100 rpm, the speed accuracy is $\pm 1\%$ of set speed. When set under 100 rpm, speed accuracy is ± 1 rpm.

Microprocessor Control: The variable speed microprocessor control provides consistent uniform shaking action. Microprocessor will display last set-point and will restart if power is interrupted.

Triple Eccentric Drive: Permanently lubricated ball bearings and maintenance free, brushless DC motor provide reliable service and continuous duty operation.

LED Display: Touchpad controls with easy-to-read, independent LED displays for speed and time allow operator to view both settings at once. Provides repeatable and accurate results every time and is easily visible across lab benches. Timer will display elapsed time or, when programmed to user defined limit, will shut off unit when time reaches zero. Display will show last used settings, even after power has been turned off.

RS232 Interface: Provides two-way communication for data logging and unit control.

Speed Calibration Mode: Allows user to automatically recalibrate speed display.

Safety Features:

Load Sensor: A built-in load sensor detects unbalanced conditions and automatically reduces rpm to a safe speed to protect samples.

Overload Protection: Audible and visual signals will activate when system detects an obstruction or overload of the tray.

Speed Ramping Feature: Slowly increases speed to desired set-point to avoid splashing.

Audible Alarm: In timed mode, alarm will sound when the time reaches zero. Alarm has optional mute function which can be set from the Touchpad control.

Spill-Resistant Design: Channels fluids away from internal components.

Operating Conditions:

Unit can be run in cold rooms, incubators, and CO₂ environments from -10 to 60°C (14 to 140°F), maximum 80% relative humidity, non-condensing.

Applications:

Cell cultures, solubility studies, and extraction procedures.

Ordering Information:

Unit includes a detachable, 3-wire cord and plug. Unit is also supplied with an 11 × 13" (27.9 × 33 cm) non-skid rubber mat.

Model	Speed Range	Speed Accuracy	Timer	Motion	Maximum Weight Capacity	Tray Material	Tray Dimensions (L × W)	Item No.
SHHD1619DG	15 to 500 rpm	above 100 rpm $\pm 1\%$ of set speed below 100 rpm ± 1 rpm	1 second to 160 hours	19 mm (0.75") orbit 19 mm (0.75") stroke	35 lbs (16 kg)	Aluminum	11 × 13" (27.9 × 33 cm)	30391807

Heavy Duty Orbital Shakers

- Microprocessor controls
- Continuous or timed operation
- 50 lb weight capacity

The OHAUS Analog 23 kg Capacity Heavy Duty Orbital Shaker is designed for applications with heavy duty loads. Shaker provides reproducible motion that is evenly distributed throughout the entire surface of the tray.

Operating Features:

Microprocessor Control: The variable speed microprocessor control provides consistent uniform shaking action. The shaker will automatically restart after a power interruption.

Triple Eccentric Drive: Permanently lubricated ball bearings and maintenance free, brushless DC motor provide reliable service and continuous duty operation.

Adjustment Knobs: Basic speed and time knobs with dial settings from 1 to 10.

Safety Features:

Speed Ramping Feature: Slowly increases speed to desired set-point to avoid splashing.

Spill-Resistant Design: Channels fluids away from internal components.

Operating Conditions:

Unit can be run in cold rooms, incubators, and CO₂ environments from 0 to 40°C (32 to 104°F), maximum 80% relative humidity, non-condensing.

Applications:

Bacterial suspensions, staining/destaining, and general mixing.

Ordering Information:

Units include a 3-wire cord and plug. Units are also supplied with an 18 × 24" (45.7 × 61 cm) non-skid rubber mat.



Model	Speed Range	Timer	Orbit	Maximum Weight Capacity	Tray Material	Tray Dimensions (L × W)	Item No.
SHHD2325AL	25 to 500 rpm	1 minute to 120 minutes	25 mm (1")	50 lbs (22.7 kg)	Aluminum	18 × 24" (45.7 × 61 cm)	30391835

Heavy Duty Orbital Shakers

- Patented Accu-Drive Shaking System
- LED displays for speed and time
- 50 lb weight capacity

The OHAUS Digital 23 kg Capacity Heavy Duty Orbital Shaker is designed for a wide range of applications with larger or heavier loads that require accurate and repeatable results.



Operating Features:

Accu-Drive Shaking System: The exclusive patented Accu-Drive Shaking System delivers exceptional speed control, accuracy, and durability. The shaking system continuously monitors shaking speed and maintains set-point, even under changing loads. When unit is set to a speed above 100 rpm, the speed accuracy is $\pm 1\%$ of set speed. When set under 100 rpm, speed accuracy is ± 1 rpm.

Microprocessor Control: The variable speed microprocessor control provides consistent uniform shaking action. Microprocessor will display last set-point and will restart if power is interrupted.

Triple Eccentric Drive: Permanently lubricated ball bearings and maintenance free, brushless DC motor provide reliable service and continuous duty operation.

LED Display: Touchpad controls with easy-to-read, independent LED displays for speed and time allow operator to view both settings at once. Provides repeatable and accurate results every time and is easily visible across lab benches. Timer will display elapsed time or, when programmed to user defined limit, will shut off unit when time reaches zero. Display will show last used settings, even after power has been turned off.

RS232 Interface: Provides two-way communication for data logging and unit control.

Speed Calibration Mode: Allows user to automatically recalibrate speed display.

Safety Features:

Load Sensor: A built-in load sensor detects unbalanced conditions and automatically reduces rpm to a safe speed to protect samples.

Overload Protection: Audible and visual signals will activate when system detects an obstruction or overload of the tray.

Speed Ramping Feature: Slowly increases speed to desired set-point to avoid splashing.

Audible Alarm: In timed mode, alarm will sound when the time reaches zero. Alarm has optional mute function which can be set from the Touchpad control.

Spill-Resistant Design: Channels fluids away from internal components.

Operating Conditions:

Unit can be run in cold rooms, incubators, and CO₂ environments from -10 to 60°C (14 to 140°F), maximum 80% relative humidity, non-condensing.

Applications:

Cell cultures, solubility studies, and extraction procedures.

Ordering Information:

Units include a detachable, 3-wire cord and plug. Units are also supplied with an 18 × 24" (45.7 × 61 cm) non-skid rubber mat.

Model	Speed Range	Speed Accuracy	Timer	Orbit	Maximum Weight Capacity	Tray Material	Tray Dimensions (L × W)	Item No.
SHHD2325DG	20 to 500 rpm	above 100 rpm $\pm 1\%$ of set speed below 100 rpm ± 1 rpm	1 second to 160 hours	25 mm (1")	50 lbs (22.7 kg)	Aluminum	18 × 24" (45.7 × 61 cm)	30391842

Heavy Duty Orbital Shakers

- Patented Accu-Drive Shaking System
- 100 lb weight capacity
- Available with either 25 or 51 mm orbit



The OHAUS Digital 45 kg Capacity Orbital Shaker is a large capacity shaker. They have a more powerful drive mechanism and larger orbits for optimal shaking of large vessels.



Operating Features:

Accu-Drive Shaking System: The exclusive patented Shaking System delivers exceptional speed control, accuracy, and durability. The shaking system continuously monitors shaking speed and maintains set-point, even under changing loads. When unit is set to a speed above 100 rpm, the speed accuracy is $\pm 1\%$ of set speed. When set under 100 rpm, speed accuracy is ± 1 rpm.

Microprocessor Control: The variable speed microprocessor control provides consistent uniform shaking action. Microprocessor will display last set-point and will restart if power is interrupted.

Triple Eccentric Drive: Permanently lubricated ball bearings and maintenance free, brushless DC motor provide reliable service and continuous duty operation.

LED Display: Touchpad controls with easy-to-read, independent LED displays for speed and time allow operator to view both settings at once. Provides repeatable and accurate results every time and is easily visible across lab benches. Timer will display elapsed time or, when programmed to user defined limit, will shut off unit when time reaches zero. Display will show last used settings, even after power has been turned off.

RS232 Interface: Provides two-way communication for data logging and unit control.

Speed Calibration Mode: Allows user to automatically recalibrate speed display.

Safety Features:

Load Sensor: A built-in load sensor detects unbalanced conditions and automatically reduces rpm to a safe speed to protect samples.

Overload Protection: Audible and visual signals will activate when system detects an obstruction or overload of the tray.

Speed Ramping Feature: Slowly increases speed to desired set-point to avoid splashing.

Audible Alarm: In timed mode, alarm will sound when the time reaches zero. Alarm has optional mute function which can be set from the Touchpad control.

Spill-Resistant Design: Channels fluids away from internal components.

Operating Conditions:

Units can be run in cold rooms, incubators, and CO₂ environments from -10 to 60°C (14 to 140°F), maximum 80% relative humidity, non-condensing.

Applications:

Cell cultures, solubility studies, and extraction procedures.

Ordering Information:

Units include a detachable, 3-wire cord and plug. Units are also supplied with a 24 x 24" (61 x 61 cm) non-skid rubber mat.

Model	Speed Range	Speed Accuracy	Timer	Orbit	Maximum Weight Capacity	Tray Material	Tray Dimensions (L x W)	Item No.
SHHD4525DG	15 to 500 rpm	above 100 rpm $\pm 1\%$ of set speed below 100 rpm ± 1 rpm	1 second to 160 hours	25 mm (1")	100 lbs (45.4 kg)	Aluminum	24 x 24" (61 x 61 cm)	30391863
SHHD4550DG	15 to 300 rpm			51 mm (2")				30391870

Heavy Duty Orbital Shakers

- Patented Accu-Drive Shaking System
- Available with either 25 or 51 mm orbit
- Calibration mode for speed



The OHAUS Digital 68 kg Capacity Orbital Shakers is the largest capacity shakers designed for the heaviest of loads. They have the most powerful drive mechanism of all the shakers and large orbits for optimal shaking of larger vessels.



Operating Features:

Accu-Drive Shaking System: The exclusive patented Accu-Drive Shaking System delivers exceptional speed control, accuracy, and durability. The system continuously monitors shaking speed and maintains set-point, even under changing loads. When unit is set to a speed above 100 rpm, the speed accuracy is $\pm 1\%$ of set speed. When set under 100 rpm, speed accuracy is ± 1 rpm.

Microprocessor Control: The variable speed microprocessor control provides consistent uniform shaking action. Microprocessor will display last set-point and will restart if power is interrupted.

Triple Eccentric Drive: Permanently lubricated ball bearings and maintenance free, brushless DC motor provide reliable service and continuous duty operation.

LED Display: Touchpad controls with easy-to-read, independent LED displays for speed and time allow operator to view both settings at once. Provides repeatable and accurate results every time and is easily visible across lab benches. Timer will display elapsed time or, when programmed to user defined limit, will shut off unit when time reaches zero. Display will show last used settings, even after power has been turned off.

RS232 Interface: Provides two-way communication for data logging and unit control.

Speed Calibration Mode: Allows user to automatically recalibrate speed display.

Safety Features:

Load Sensor: A built-in load sensor detects unbalanced conditions and automatically reduces rpm to a safe speed to protect samples.

Overload Protection: Audible and visual signals will activate when system detects an obstruction or overload of the tray.

Speed Ramping Feature: Slowly increases speed to desired set-point to avoid splashing.

Audible Alarm: In timed mode, alarm will sound when the time reaches zero. Alarm has optional mute function which can be set from the Touchpad control.

Spill-Resistant Design: Channels fluids away from internal components.

Operating Conditions:

Units can be run in cold rooms, incubators, and CO₂ environments from -10 to 60°C (14 to 140°F), maximum 80% relative humidity, non-condensing.

Applications:

Cell cultures, solubility studies, and extraction procedures.

Ordering Information:

Units include a detachable, 3-wire cord and plug. Units are also supplied with a 24 × 36" (61 × 91 cm) non-skid rubber mat.

Model	Speed Range	Speed Accuracy	Timer	Orbit	Maximum Weight Capacity	Tray Material	Tray Dimensions (L × W)	Item No.
SHHD6825DG	15 to 500 rpm	above 100 rpm $\pm 1\%$ of set speed below 100 rpm ± 1 rpm	1 second to 160 hours	25 mm (1")	150 lbs (68 kg)	Aluminum	24 × 36" (61 × 91 cm)	30391877
SHHD6850DG	15 to 300 rpm			51 mm (2")				30391884

Rocking & Waving Shakers

- Variable control for speed, tilt and time
- 16 lb capacity
- Two-tier model doubles workable capacity

The OHAUS Analog Rocking Shaker is an easy and economical option for all of your rocking needs. The Rocking Shaker is ideal for cell culture and blotting applications and is designed to be used in a variety of environmental conditions. Rocker is supplied with an 14 × 11" (35.6 × 27.9 cm) non-skid rubber mat.

Operating Features:

Low Profile Design: Takes up less bench space and fits into most hoods and incubators. Two-tier option increases the capacity with the same footprint and provides a 3.5" (8.9 cm) clearance between platforms. Cast aluminum base offers durability and added stability

Microprocessor Control: The microprocessor control provides tilt adjustment which allows user to easily adjust rocking angle from 0 to 15° while unit is operating. Smooth speed control with low speed rocking motion.

Independent Control Knobs: Independent control knobs for speed, tilt, and time, allow for easy adjustments.

Safety Features:

Overload Protection: Audible signal will activate when system detects an obstruction or overload of the tray.

Speed Ramping Feature: Slowly increases speed to desired set-point to avoid splashing.

Timer: Timer will automatically stop rocking motion when timer reaches zero.

Spill-Resistant Design: Channels fluids away from internal components.

Operating Conditions:

Unit can be run in cold rooms, incubators, and CO₂ environments from -10 to 60°C (14 to 140°F), maximum 80% relative humidity, non-condensing.

Applications:

Staining and destaining gels, hybridization procedures, hematology, and blotting techniques.

Ordering Information:

Units include a detachable, 3-wire cord and plug. Units are also supplied with a 14 × 11" (35.6 × 27.9 cm) non-skid rubber mat. Two-tier models include a 2nd tray, non-skid mat and hardware.



Model	Speed Range	Tilt Angle	Timer	Maximum Weight Capacity	Tray Material	Tray Dimensions (L × W)	Item No.
SHRK07AL1	1 to 75 rpm*	0 to 15°*	1 minute to 120 minutes	16 lbs (7.3 kg)**	Aluminum	14 × 11" (35.6 × 27.9 cm)	30391959
SHRK07AL2							30391966

* Maximum speed/tilt angle may vary with heavy or unbalanced loads.

** Centered on tray.

Rocking & Waving Shakers

- Electronic tilt adjustment from 0 to 15° while unit is operating
- Displays for speed, tilt angle and time
- Timer with audible alarm

The OHAUS Digital Rocking Shaker is ideal for cell culture work and is designed to be used in a variety of environmental conditions.

Operating Features:

Low Profile Design: Takes up less space and easily fits into most hoods and incubators. Cast aluminum base offers durability and added stability.

Microprocessor Control: The microprocessor control provides electronic tilt angle adjustment which allows user to easily adjust rocking angle from 0 to 15° while unit is operating. Precise speed control provides smooth, low-speed rocking motion down to 1 rpm.

LED Display: Touchpad controls with easy-to-read, independent LED displays for speed and tilt angle, and time allow operator to view all settings at once. Provides repeatable and accurate results every time and is easily visible across lab benches. Timer will display elapsed time or, when programmed to user defined limit, will shut off unit when time reaches zero. Display will show last used settings, even after power has been turned off.

Safety Features:

Overload Protection: Audible and visual signals will activate when system detects an obstruction or overload of the tray.

Speed Ramping Feature: Slowly increases speed to desired set-point to avoid splashing.

Audible Alarm: In timed mode, alarm will sound when the time reaches zero.

Spill-Resistant Design: Channels fluids away from internal components.

Operating Conditions:

Unit can be run in cold rooms, incubators, and CO₂ environments from -10 to 60°C (14 to 140°F), maximum 80% relative humidity, non-condensing.

Applications:

Staining and destaining gels, hybridization procedures, hematology, and blotting techniques.

Ordering Information:

Units include a detachable, 3-wire cord and plug. Units are also supplied with a 12.75 × 10" (32.4 × 25.4 cm) non-skid rubber mat.



Model	Speed Range	Speed Accuracy	Tilt Angle	Timer	Maximum Weight Capacity	Tray Material	Tray Dimensions (L × W)	Item No.
SHRK04DG	1 to 50 rpm*	± 1 rpm	0 to 15°*	1 second to 160 hours	10 lbs (4.5 kg)**	Aluminum	12.75 × 10" (32.4 × 25.4 cm)	30391994

* Maximum speed/tilt angle may vary with heavy or unbalanced loads.

** Centered on tray.

Rocking & Waving Shakers

- Variable control for speed, tilt and time
- 5 lb capacity
- Large 14 × 11" tray

The OHAUS Analog Waving Shakers are an easy and economical option for all of your waving needs. Ideal for cell culture and blotting applications, and is designed to be used in a variety of environmental conditions.

Operating Features:

Low Profile Design: Takes up less space and easily fits into most hoods and incubators. Cast aluminum base offers durability and added stability.

Microprocessor Control: Provides tilt adjustment which allows user to easily adjust waving angle from 0 to 16° while unit is operating. Smooth speed control with low speed waving motion.

Independent Control Knobs: Independent control knobs for speed, tilt and time allow for easy adjustments.

Safety Features:

Overload Protection: Audible and visual signals will activate when system detects an obstruction or overload of the tray.

Speed Ramping Feature: Slowly increases speed to desired set-point to avoid splashing.

Timer: Timer, if engaged, will automatically stop waving motion when timer reaches zero.

Spill-Resistant Design: Channels fluids away from internal components.

Operating Conditions:

Unit can be run in cold rooms, incubators, and environments from -10 to 60°C (14 to 140°F), maximum 80% relative humidity, non-condensing.

Applications:

Staining and destaining gels, hybridization procedures, hematology, and blotting techniques.

Ordering Information:

Units include a detachable, 3-wire cord and plug. Units are also supplied with a 14 × 11" (35.6 × 27.9 cm) non-skid rubber mat.

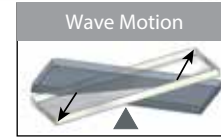

Model	Speed Range	Tilt Angle	Timer	Maximum Weight Capacity	Tray Material	Tray Dimensions (L × W)	Item No.
SHWV02AL	1 to 75 rpm*	0 to 16°*	1 minute to 120 minutes	5 lbs (2.3 kg)**	Aluminum	14 × 11" (35.6 × 27.9 cm)	30391973

* Maximum speed/tilt angle may vary with heavy or unbalanced loads.

** Centered on tray.

Rocking & Waving Shakers

- Electronic tilt adjustment from 0 to 20° while unit is operating
- Displays for speed and tilt angle, and time
- Timer with audible alarm

The OHAUS Digital Waving Shaker provides precise speed control and a smooth, low foaming, three dimensional, "wave" motion. Ideal for use in a wide range of laboratory applications and designed to be used in a variety of environmental conditions. Tray includes a non-skid rubber mat that is suitable for holding Petri dishes.

Operating Features:

Low Profile Design: Takes up less space and easily fits into most hoods and incubators. Cast aluminum base offers durability and added stability.

Microprocessor Control: The microprocessor control provides electronic tilt angle adjustment which allows user to easily adjust waving angle from 0 to 20° while unit is operating. Precise speed control provides smooth, low-speed waving motion down to 1 rpm.

LED Display: Touchpad controls with easy-to-read, independent LED displays for speed and tilt angle, and time allow operator to view all settings at once. Provides repeatable and accurate results every time and is easily visible across lab benches. Timer will display elapsed time or, when programmed to user defined limit, will shut off unit when time reaches zero. Display will show last settings, even after power has been turned off.

Safety Features:

Overload Protection: Audible and visual signals will activate when system detects an obstruction or overload of the tray.

Speed Ramping Feature: Slowly increases speed to desired set-point to avoid splashing.

Audible Alarm: In timed mode, alarm will sound when the time reaches zero.

Spill-Resistant Design: Channels fluids away from internal components.

Operating Conditions:

Unit can be run in cold rooms, incubators, and CO₂ environments from -10 to 60°C (14 to 140°F), maximum 80% relative humidity, non-condensing.

Applications:

Blood samples, DNA extractions, blotting techniques, and general mixing of various size tubes.

Ordering Information:

Units include a detachable, 3-wire cord and plug. Units are also supplied with an 11.75 × 8.75" (29.9 × 22.2 cm) non-skid rubber mat.

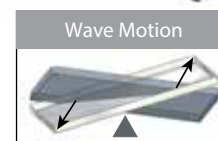

Model	Speed Range	Speed Accuracy	Tilt Angle	Timer	Maximum Weight Capacity	Tray Material	Tray Dimensions (L × W)	Item No.
SHWV02DG	1 to 30 rpm*	± 1 rpm	0 to 20°*	1 second to 160 hours	5 lbs (2.3 kg)**	Aluminum	11.75 × 8.75" (29.9 × 22.2 cm)	30391947

* Maximum speed/tilt angle may vary with heavy or unbalanced loads.

** Centered on tray.

Reciprocating Shakers

- Exceptional speed control, accuracy and durability
- LED displays for speed and time
- Calibration mode for speed

The OHAUS Digital Reciprocating Shakers are designed for a wide range of applications, including cell cultures, that require accurate and repeatable results. The microprocessor control provides consistent uniform shaking while safely ramping to the set speed.



Operating Features:

The shaking system in both models continuously monitors shaking speed and maintains set-point, even under changing loads. When unit is set to a speed above 100 rpm, the speed accuracy is $\pm 1\%$ of set speed. When set under 100 rpm, speed accuracy is ± 1 rpm.

Microprocessor Control: The variable speed microprocessor control provides consistent uniform shaking action. Microprocessor will display last set-point and will restart if power is interrupted.

Single Eccentric Drive: Permanently lubricated ball bearings and maintenance free, brushless DC motor provide reliable service and continuous duty operation. **LED Display:** Touchpad controls with easy-to-read, independent LED displays for speed and time allow operator to view both settings at once. Provides repeatable and accurate results every time and is easily visible across lab benches. Timer will display elapsed time or, when programmed to user defined limit, will shut off unit when time reaches zero. Display will show last used settings, even after power has been turned off.

RS232 Interface: Provides two-way communication for data logging and unit control.

Speed Calibration Mode: Allows user to automatically recalibrate speed display.

Safety Features:

Load Sensor: A built-in load sensor detects unbalanced conditions and automatically reduces rpm to a safe speed to protect samples.

Overload Protection: Audible and visual signals will activate when system detects an obstruction or overload of the tray.

Speed Ramping Feature: Slowly increases speed to desired set-point to avoid splashing.

Audible Alarm: In timed mode, alarm will sound when the time reaches zero. Alarm has optional mute function which can be set from the Touchpad control.

Spill-Resistant Design: Channels fluids away from internal components.

Operating Conditions:

Unit can be run in cold rooms, incubators, and CO₂ environments from -10 to 60°C (14 to 140°F), maximum 80% relative humidity, non-condensing.

Applications:

Cell cultures, solubility studies, and extraction procedures.

Ordering Information:

Unit includes a detachable, 3-wire cord and plug. Unit is also supplied with an 11 × 13" (27.9 × 33 cm) non-skid rubber mat.

Model	Speed Range	Speed Accuracy	Timer	Stroke	Maximum Weight Capacity	Tray Material	Tray Dimensions (L × W)	Item No.
SHRC0719DG	20 to 300 rpm	above 100 rpm $\pm 1\%$ of set speed below 100 rpm ± 1 rpm	1 second to 160 hours	19 mm (0.75")	15 lbs (6.8 kg)	Aluminum	11 × 13" (27.9 × 33 cm)	30391828

Incubating & Incubating Cooling Selector Guide



Product Family	Incubating Cooling Thermal Shakers	Incubating Light Duty Orbital Shaker	Incubating Light Duty Orbital Shakers
Model	ISTHBLCTS (Heat/Cool) ISTHBLHTS (Heat)	ISLD04HDG	ISLDMPHDG ISLDMPHDGL
Temperature Range	17 below ambient to 100°C / ambient +4 to 100°C	Ambient +5° to 65°C	Ambient +5° to 65°C
Speed Range	300 to 3000 rpm	100 to 1200 rpm	100 to 1200 rpm
Timer	1 minute to 99 hours, 59 min	1 second to 160 hours	1 second to 160 hours
Motion	Orbital	Orbital	Orbital
Orbit	3 mm	3 mm	3 mm
Max Weight Capacity	1 Block	8 lbs	4 Microplates / 2 Micro-Tube Racks
Audible Alarm	●	●	●
Load Sensor	●	—	—
Drive System	—	Triple Eccentric	Triple Eccentric
Motor Type	Brushless DC Motor	Brushless DC Motor	Brushless DC Motor
Set-Point Retention	● Displays Last Setting	● Displays Last Setting	● Displays Last Setting
Restart/Power Out	●	●	●
Ramp to Speed	●	●	●
Temperature Overshoot Protection	●	—	—
Overload Protection	●	●	●
User Calibration (Temperature)	●	●	●
User Calibration (Speed)	●	—	—
Interface	USB	—	—
Overall Dimensions (L x W x H)	10.59 x 10.31 x 5.39"	17 x 11 x 10.5"	17 x 11 x 7.75"
Included Tray (L x W)	N/A	11 x 7.75"	11 x 7.75"
Platform Options (L x W)	N/A	N/A	N/A

Incubating & Incubating Cooling Selector Guide



Product Family	Incubating Cooling Light Duty Orbital Shaker	Incubating Rocking Shaker	Incubating Waving Shaker
Model	ISICMBCDG	ISRK04HDG	ISWW02HDG
Temperature Range	10°C Below Ambient to 65°C	Ambient +5° to 65°C	Ambient +5° to 65°C
Speed Range	100 to 1200 rpm	1 to 50 rpm	1 to 30 rpm
Timer	1 second to 160 hours	1 second to 160 hours	1 second to 160 hours
Motion	Orbital	Rocking	Waving
Orbit	3 mm	Tilt Angle: 0 to 15° *	Tilt Angle: 0 to 20° *
Max Weight Capacity	2 Microplates 2 Modular Blocks	10 lbs**	5 lbs**
Audible Alarm	●	●	—
Load Sensor	—	—	—
Drive System	Triple Eccentric	Cable	Cable
Motor Type	Brushless DC Motor	Stepper Motor	Stepper Motor
Set-Point Retention	● Displays Last Setting	● Displays Last Setting	● Displays Last Setting
Restart/Power Out	●	●	—
Ramp to Speed	●	●	—
Temperature Overshoot Protection	—	—	—
Overload Protection	●	●	—
User Calibration (Temperature)	—	—	—
User Calibration (Speed)	—	—	—
Interface	—	—	—
Overall Dimensions (L x W x H)	16.49 x 10.11 x 10.98"	17 x 11 x 10.5"	17 x 11 x 10.5"
Included Tray (L x W)	N/A	10 x 7.5"	9.25 x 7.25"
Platform Options (L x W)	N/A	N/A	N/A

● Yes * Maximum speed/tilt angle may vary with heavy or unbalanced loads.
** Centered on tray.

Incubating Cooling Thermal Shakers

- 4.3" color LCD touchscreen display provides an intuitive interface
- Rapid heating, cooling and high speed shaking ability
- Internal memory stores five separate 5-step programs, unlimited with USB

The OHAUS Thermal Shakers and Cooling Thermal Shakers are designed for applications that require consistent and precise results. With heating, cooling and shaking capabilities. These shakers use interchangeable blocks to accommodate a wide variety of tubes and microplates. The easy-to-use, 4.3", color, LCD touchscreen allows the user to save and visibly track progress through the live status bar for five user defined programs, each with five individual steps. The unit's enhanced electronics and dual temperature sensors provide accurate, dependable temperature settings across the operating range.



Operating Features:

Low Profile Design: The low profile design minimizes the unit's footprint on the bench.

LCD Touchscreen: Enables faster setting of temperature, speed, and time which can all be viewed at once. Display features on-screen help topics with operational tips available in six languages. Touchscreen is compatible with rubber gloves used in labs. USB port can transfer information to a flash drive for data logging, program storage and software updates.

Program Control: Program control capabilities allow user programmable operation for automated use and memory. Storage for five separate 5-step programs, or unlimited number of programs with the use of the USB.

Temperature ramp rate: Adjustable temperature ramp rate feature separately defines the heating and cooling rate in increments of 0.5°C/min.

Single Point Calibration Mode: For maximum temperature accuracy, the single point calibration procedure allows the user to calibrate up to 6 different user defined temperatures.

Pulse Mode Feature: The unit is equipped with a pulse mode feature for quick vortex applications.

Safety Features:

Cool Touch Housing: Constructed from a high-quality, heat and chemical resistant polymer. The unit's housing remains cool to the touch throughout normal operating temperatures.

Maximum Temperature Limiting Function: Ensures the temperature will not exceed preset limits, allowing the user control of temperature sensitive samples.

Hot Top Indicator: A hot top warning light will illuminate when the temperature reaches 40°C, and will remain lit until the unit is sufficiently cooled.

Audible Alarm: In timed mode, an alarm will sound when the time reaches zero or set-point temperature is reached. Additionally, the heat function will automatically shut off if the unit recognizes an internal issue.

Automatic Block Recognition:

The unit will read the specific block being used and prevents potential over-speed programming.

Operating Conditions:

Unit can operate in conditions from 5 to 35°C (41 to 95°F), maximum 80% relative humidity, non-condensing.

Applications:

Cell cultures, DNA, RNA, and protein studies.

Ordering Information

Unit includes a detachable, 3-wire cord and plug . Unit is also supplied with a 1.5 mL block, clear rack, and cover.

Model	Temperature Range	Temperature Accuracy	Speed Range	Speed Accuracy	Timer	Orbit	Cooling Rate	Heating Rate	Item No.
ISTHBLHTS	4°C above ambient to 100°C	± 1°C between 20°C and 45°C ± 2°C above 45°C	300 to 3000 rpm	± 2%	1 minute to 99 hours, 59 minutes	3 mm (0.12")	above ambient 2-3°C/min	5°C/min	30392003
ISTHBLCTS	17°C below ambient to 100°C	± 0.5°C between 20°C and 45°C ± 2°C below 20°C and above 45°C					below ambient 0.5-1.0°C/min		30391996

Incubating Cooling Thermal Shakers Modular Blocks



Microplate Block

Sample Type	Well Size	Well Depth	Dimensions (L x W x H)	Item No.
Microplate Thermal Block with Lid	4.21 x 2.81 x 0.1" (10.7 x 7.1 x 0.25 cm)	0.9" (2.30 cm)	4.7 x 6.4 x 3.0" (11.9 x 16.3 x 7.6 cm)	30400126

Sample Type	Well Diameter	Well Depth	Dimensions (L x W x H)	Item No.
384 Well Plate Thermal Block with Lid	0.16" (0.40 cm)	0.32" (0.81 cm)	4.7 x 6.4 x 3.0" (11.9 x 16.3 x 7.6 cm)	30400127
0.2 mL PCR Plate Thermal Block with Lid	0.25" (0.64 cm)	0.50" (1.27 cm)	4.7 x 6.4 x 3.0" (11.9 x 16.3 x 7.6 cm)	30400128

Tube Blocks

Sample Type	No. of Wells	Well Diameter	Well Depth	Dimensions (L x W x H)	Item No.
0.5 mL Microtubes*	30	0.31" (0.79 cm)	0.97" (2.46 cm)	4.0 x 5.6 x 1.8" (10.2 x 14.2 x 4.6 cm)	30400129
1.5 mL Microtubes*	24	0.44" (1.11 cm)	1.39" (3.53 cm)	4.0 x 5.6 x 2.1" (10.2 x 14.2 x 5.3 cm)	30400130
2.0 mL Microtubes*	24	0.45" (1.15 cm)	1.39" (3.53 cm)	4.0 x 5.6 x 2.1" (10.2 x 14.2 x 5.3 cm)	30400131
12 mm Tubes	24	0.47" (1.20 cm)	1.42" (3.61 cm)	4.0 x 5.6 x 2.2" (10.2 x 14.2 x 5.6 cm)	30400132

* Supplied with clear rack and cover

Racks and Covers

Description	Item No.
Rack For 30 X 0.5 mL Tube Block	30400250
Rack For 24X1.5 / 24X2.0 mL Tube Blocks	30400251
Cover For 0.5mL/1.5mL/2.0mL Tube Blocks	30400252

Cryotube Block

Sample Type	No. of Wells	Well Diameter	Well Depth	Dimensions (L x W x H)	Item No.
2.0 mL Cryotubes	24	0.50" (1.26 cm)	1.42" (3.6 cm)	4.0 x 5.6 x 2.2" (10.2 x 14.2 x 5.6 cm)	30400133

Conical Tube Blocks

Sample Type	No. of Wells	Well Diameter	Well Depth	Dimensions (L x W x H)	Item No.
5 mL Eppendorf Tube Block	9	0.66" (1.68 cm)	1.93" (4.9 cm)	4.1 x 5.7 x 2.8" (10.4 x 14.5 x 7.1 cm)	30400134
15 mL Conical Tubes	9	0.68" (1.73 cm)	4.11" (10.44 cm)	4.2 x 5.7 x 5.0" (10.7 x 14.7 x 12.7 cm)	30400135
50 mL Conical Tubes	4	1.18" (3.0 cm)	3.97" (10.09 cm)	4.0 x 5.7 x 4.8" (10.2 x 14.5 x 12.2 cm)	30400136

Incubating Light Duty Orbital Shakers

- LED displays for temperature, speed and time
- Timer with audible alarm
- Calibration mode for temperature

The OHAUS Incubating Light Duty Orbital Shakers are designed to heat and shake a variety of samples.

Operating Features:

Microprocessor Control: The variable speed microprocessor control provides consistent uniform shaking action. Microprocessor will display last set-point and will restart if power is interrupted.

PID Temperature Controller: Maintains precise temperature control from ambient +5°C to 65°C. Easy-to-use controls allow users to adjust temperature in 1°C increments.

Triple Eccentric Drive: Permanently lubricated ball bearings and maintenance free, brushless DC motor provide reliable service and continuous duty operation.

LED Display: Touchpad controls with easy-to-read, independent LED displays for temperature, speed and time allow operator to view all settings at once. Provides repeatable and accurate results every time and is easily visible across lab benches. Timer will display elapsed time or, when programmed to user defined limit, will shut off unit when time reaches zero. Display will show last used settings, even after power has been turned off.

Temperature Calibration Mode: Allows user to calibrate unit to an external temperature device.

Safety Features:

Overload Protection: Audible and visual signals will activate when system detects an obstruction or overload of the tray.

Speed Ramping Feature: Slowly increases speed to desired set-point to avoid splashing.

Audible Alarm: In timed mode, alarm will sound when the time reaches zero.

Caution Hot Indicator: Symbol illuminates when the temperature of the air in the chamber reaches 40°C and remains lit until temperature cools down.

Spill-Resistant Design: Channels fluids away from internal components.

Polycarbonate Lid: Permits viewing of samples without disturbing internal temperature.

Operating Conditions:

Unit can be run in conditions from 5 to 40°C (41 to 104°F), maximum 80% relative humidity, non-condensing.

Applications:

Cell cultures, bacterial suspensions, and hybridizations.

Ordering Information:

Unit includes a detachable, 3-wire cord and plug.



Model	Temp. Range	Temp. Uniformity	Speed Range	Speed Accuracy	Timer	Orbit	Maximum Weight Capacity	Tray Dimensions (L x W)	Interior Dimensions (L x W x H)	Item No.
ISLD04HDG	Ambient +5°C to 65°C	± 0.5°C at 37°C	100 to 1200 rpm	± 2% of set speed	1 second to 160 hours	3 mm (0.12")	8 lbs (3.6 kg)	11 x 7.75" (27.9 x 19.7 cm)	11.3 x 8.3 x 5.7" (28.7 x 21.1 x 14.5 cm)	30391924

Incubating Light Duty Orbital Shakers



- LED displays for temperature, speed and time
- Timer with audible alarm
- Available with opaque lid for light sensitive samples

The OHAUS Incubating Microplate Shakers are optimized for shaking microplates, deep-well plates, or micro-tubes.

Operating Features:

Microprocessor Control: The variable speed microprocessor control provides consistent uniform shaking action. Microprocessor will display last set-point and will restart if power is interrupted.

PID Temperature Controller: Maintains precise temperature control from ambient +5°C to 65°C. Easy-to-use controls allow users to adjust temperature in 1°C increments.

Triple Eccentric Drive: Permanently lubricated ball bearings and maintenance free, brushless DC motor provide reliable service and continuous duty operation.

LED Display: Touchpad controls with easy-to-read, independent LED displays for temperature, speed, and time allow operator to view all settings at once. Provides repeatable and accurate results every time and is easily visible across lab benches. Timer will display elapsed time or, when programmed to user defined limit, will shut off unit when time reaches zero. Display will show last used settings, even after power has been turned off.

Temperature Calibration Mode: Allows user to calibrate unit to an external temperature device.

Safety Features:

Overload Protection: Audible and visual signals will activate when system detects an obstruction or overload of the tray.

Speed Ramping Feature: Slowly increases speed to desired set-point to avoid splashing.

Audible Alarm: In timed mode, alarm will sound when the time reaches zero.

Caution Hot Indicator: Symbol illuminates when the temperature of the air in the chamber reaches 40°C and remains lit until temperature cools down.

Spill-Resistant Design: Channels fluids away from internal components.

Polycarbonate Lid: Clear lid permits viewing of samples without disturbing internal temperature. Opaque lid prohibits light exposure to light sensitive samples.

Operating Conditions:

Unit can be run in conditions from 5 to 40°C (41 to 104°F), maximum 80% relative humidity, non-condensing.

Applications:

Immunoassays and hybridizations.

Ordering Information:

Units include a detachable, 3-wire cord and plug.



Model	Temp. Range	Temp. Uniformity	Speed Range	Speed Accuracy	Timer	Orbit	Maximum Weight Capacity	Tray Dimensions (L x W)	Item No.
ISLDMPHDG	Ambient +5°C to 65°C	± 0.5°C at 37°C	100 to 1200 rpm	± 2%	1 second to 160 hours	3 mm (0.12")	4 micro-plates or 2 micro-tube racks	11 x 7.75" (27.9 x 19.7 cm)	30391938
ISLDMPHDGL*									30391931

*Unit includes opaque lid

Incubating Cooling Orbital Shakers

- Heats to 65°C and cools to 10°C below ambient
- LED displays for temperature, speed and time
- Calibration mode for temperature

The OHAUS Incubating/Cooling Orbital Shaker is microplate ready without the need for any additional accessories. Optional modular blocks can accommodate micro-tubes, centrifuge tubes, vials, or culture tubes. Unit holds microplates or modular blocks with a 5" (12.7 cm) tall interior capacity. Ideal for analyses that require a stable, controlled temperature.



Operating Features:

Microprocessor Control: The variable speed microprocessor control provides consistent uniform shaking action. Microprocessor will display last set-point and will restart if power is interrupted.

PID Temperature Controller: Maintains precise temperature control from 10°C below ambient to 65°C. Easy-to-use controls allow users to adjust temperature in 1°C increments.

Triple Eccentric Drive: Permanently lubricated ball bearings and maintenance free, brushless DC motor provide reliable service and continuous duty operation.

LED Display: Touchpad controls with easy-to-read, independent LED displays for temperature, speed, and time allow operator to view all settings at once. Provides repeatable and accurate results every time and is easily visible across lab benches. Timer will display elapsed time or, when programmed to user defined limit, will shut off unit when time reaches zero. Display will show last used settings, even after power has been turned off.

Temperature Calibration Mode: Allows user to calibrate unit to an external temperature device.

Safety Features:

Overload Protection: Audible and visual signals will activate when system detects an obstruction or overload of the tray.

Speed Ramping Feature: Slowly increases speed to desired set-point to avoid splashing.

Audible Alarm: In timed mode, alarm will sound when the time reaches zero. Alarm has optional mute function which can be set from the Touchpad control.

Caution Hot Indicator: Symbol illuminates when the temperature of the air in the chamber reaches 40°C and remains lit until temperature cools down.

Spill-Resistant Design: Channels fluids away from internal components.

Polycarbonate Lid: Permits viewing of samples without disturbing internal temperature.

Operating Conditions:

Unit can be run in conditions from 5 to 40°C (41 to 104°F), maximum 80% relative humidity, non-condensing.

Applications:

Cell and bacterial cultures, hybridizations, and enzyme reactions.

Ordering Information:

Unit includes a detachable, 3-wire cord and plug. Units are also supplied with an adapter bracket to hold optional modular blocks. See page 151-152 for block options.

Model	Temp. Range	Temp. Uniformity	Speed Range using Microplates	Speed Range using Modular Blocks	Speed Accuracy	Timer	Orbit	Maximum Weight Capacity	Item No.
ISICMBCDG	10°C below ambient to 65°C	± 0.5°C at 37°C	100 to 1200 rpm	100 to 600 rpm	± 2%	1 second to 160 hours	3 mm (0.12")	2 micro-plates or 2 modular blocks	30391945

Incubating Light Duty Orbital Shakers Modular Blocks



Modular Blocks

Modular Blocks are constructed from a solid anodized aluminum block. The close contact of tubes to block walls allow for maximum temperature transfer.

Block dimensions (L × W × H): 3.75 × 3 × 2" (9.5 × 7.6 × 5.1 cm)

Applications: Cell cultures, hybridizations, and extraction procedures

OHAUS modular blocks also fit in the OHAUS Dry Block Heaters.

Constructed of anodized aluminum, this material is ideal for its temperature conducting and corrosion resistant properties.

Microcentrifuge Tube Blocks

Single block

Sample Type	No. of Wells	Well Diameter	Well Depth	Item No.
0.5 mL tube	30	7.9 mm	27.6 mm	30400157
1.5 mL tube	20	11.1 mm	39.1 mm	30400159
2 mL tube	20	11.5 mm	38.1 mm	30400191



Conical-Bottom Centrifuge Tube Blocks

Single block

Sample Type	No. of Wells	Well Diameter	Well Depth	Item No.
15 mL tube	12	17.1 mm	44.5 mm	30400172
50 mL tube	5	29.0 mm	47.6 mm	30400168



Incubating Light Duty Orbital Shakers Modular Blocks

Standard Test Tube Blocks

Single block

Sample Type	No. of Wells	Well Diameter	Well Depth	Item No.
6 mm tube	30	8.3 mm	48.4 mm	30400158
10 mm tube	24	10.7 mm	48.4 mm	30400151
12/13 mm tube	20	13.9 mm	48.4 mm	30400152



Centrifuge Tube Combination Block

Single block

These blocks have been designed for variable sized samples.

Sample Type	No. of Wells	Well Diameter	Well Depth	Item No.
Test Tube Combination				
6 mm	6	8.3 mm	48.4 mm	30400156
12/13 mm	5	13.8 mm	48.4 mm	
25 mm	3	26.2 mm	48.4 mm	
Centrifuge Tube Combination				
1.5 mL	4	11.1 mm	39.1 mm	30400193
15 mL	3	17.1 mm	44.5 mm	
50 mL	2	29.0 mm	47.6 mm	
Micro-Tube Combination				
0.5 mL	6	7.9 mm	27.6 mm	30400194
1.5 mL	10	11.1 mm	39.1 mm	
2 mL	5	11.5 mm	38.1 mm	



Vial Blocks

Single block

Designed for sample/serum and scintillation vials.

Sample Type	No. of Wells	Well Diameter	Well Depth	Item No.
12 mm vial	20	12.7 mm	30 mm	30400182
15 mm vial	20	15.8 mm	35 mm	30400183
16 mm vial	15	16.4 mm	45 mm	30400190
17 mm vial	12	17.8 mm	45 mm	30400184
19 mm vial	12	19.7 mm	45 mm	30400185
21 mm vial	9	21.7 mm	45 mm	30400186
23 mm vial	8	23.8 mm	45 mm	30400187
25 mm vial	8	25.8 mm	45 mm	30400188
28 mm vial	6	28.8 mm	45 mm	30400189



Incubating Rocking & Waving Shakers

- Electronic tilt adjustment from 0 to 15° while unit is operating
- LED displays for temperature, speed and tilt angle, and time
- Timer with audible alarm

The OHAUS Incubating Rocking Shaker combines smooth rocking motion and general purpose incubation in one compact bench top unit.

Operating Features:

Microprocessor Control: The microprocessor control provides electronic tilt angle adjustment which allows user to easily adjust rocking angle from 0 to 15° while unit is operating. Precise speed control provides smooth, low-speed rocking motion down to 1 rpm.

PID Temperature Controller: Maintains precise temperature control from ambient +5°C to 65°C. Easy-to-use controls allow users to adjust temperature in 1°C increments.

LED Display: Touchpad controls with easy-to-read, independent LED displays for temperature, speed and tilt angle, and time allow operator to view all settings at once. Provides repeatable and accurate results every time and is easily visible across lab benches. Timer will display elapsed time or, when programmed to user defined limit, will shut off unit when time reaches zero. Display will show last used settings, even after power has been turned off.

Safety Features:

Overload Protection: Audible and visual signals will activate when system detects an obstruction or overload of the tray.

Speed Ramping Feature: Slowly increases speed to desired set-point to avoid splashing.

Audible Alarm: In timed mode, alarm will sound when the time reaches zero.

Caution Hot Indicator: Symbol illuminates when the temperature of the air in the chamber reaches 40°C and remains lit until temperature cools down.

Spill-Resistant Design: Channels fluids away from internal components.

Polycarbonate Lid: Permits viewing of samples without disturbing internal temperature.

Operating Conditions:

Unit can be run in conditions from 5 to 40°C (41 to 104°F), maximum 80% relative humidity, non-condensing.

Applications:

Cell cultures, staining and destaining gels, hybridization procedures, and blotting techniques.

Ordering Information:

Unit includes a detachable, 3-wire cord and plug.



Model	Temp. Range	Temp. Uniformity	Speed Range	Speed Accuracy	Tilt Angle	Timer	Maximum Weight Capacity	Tray Dimensions (L x W)	Interior Dimensions (L x W x H)	Item No.
ISRK04HDG	Ambient +5°C to 65°C	± 0.5°C at 37°C	1 to 50 rpm *	± 1 rpm	0 to 15° *	1 second to 160 hours	10 lbs (4.5 kg) **	10 x 7.5" (25.4 x 19.1 cm)	10.75 x 7.75 x 3.8" (27.3 x 19.7 x 9.7 cm)	30391980

* Maximum speed/tilt angle may vary with heavy or unbalanced loads.

** Centered on tray.

Incubating Rocking & Waving Shakers

- Electronic tilt adjustment from 0 to 20° while unit is operating
- LED displays for temperature, speed and tilt angle, and time
- Timer with audible alarm

The OHAUS Incubating Waving Shaker combines the unique vertical and horizontal “wave” motion with general purpose incubation in one compact bench top unit.

Operating Features:

Microprocessor Control: The microprocessor control provides electronic tilt angle adjustment which allows user to easily adjust waving angle from 0 to 20° while unit is operating. Precise speed control provides smooth, low-speed waving motion down to 1 rpm.

PID Temperature Controller: Maintains precise temperature control from ambient +5°C to 65°C. Easy-to-use controls allow users to adjust temperature in 1°C increments..

LED Display: Touchpad controls with easy-to-read, independent LED displays for temperature, speed and tilt angle, and time allow operator to view all settings at once. Provides repeatable and accurate results every time and is easily visible across lab benches. Timer will display elapsed time or, when programmed to user defined limit, will shut off unit when time reaches zero. Display will show last used settings, even after power has been turned off.

Safety Features:

Overload Protection: Audible and visual signals will activate when system detects an obstruction or overload of the tray.

Speed Ramping Feature: Slowly increases speed to desired set-point to avoid splashing.

Audible Alarm: In timed mode, alarm will sound when the time reaches zero.

Caution Hot Indicator: Symbol illuminates when the temperature of the air in the chamber reaches 40°C and remains lit until temperature cools down.

Spill-Resistant Design: Channels fluids away from internal components.

Polycarbonate Lid: Permits viewing of samples without disturbing internal temperature.

Operating Conditions:

Unit can be run in conditions from 5 to 40°C (41 to 104°F), maximum 80% relative humidity, non-condensing.

Applications:

Cell cultures, hybridization procedures, and blotting techniques.

Ordering Information:

Unit includes a detachable, 3-wire cord and plug.

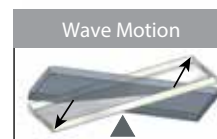

Model	Temp. Range	Temp. Uniformity	Speed Range	Speed Accuracy	Tilt Angle	Timer	Maximum Weight Capacity	Tray Dimensions (L x W)	Interior Dimensions (L x W x H)	Item No.
ISWV02HDG	Ambient +5°C to 65°C	± 0.5°C at 37°C	1 to 30 rpm *	± 1 rpm	0 to 20° *	1 second to 160 hours	5 lbs (2.3 kg) **	9.25 x 7.25" (23.5 x 18.4 cm)	10.75 x 7.75 x 3.4" (27.3 x 19.7 x 8.6 cm)	30391987

* Maximum speed/tilt angle may vary with heavy or unbalanced loads.

** Centered on tray.

Open Air , Incubating , Incubating Cooling Shakers Accessories

Universal Platforms

Allows for mounting of flask clamps, test tube racks, and bottle clamps. Platform slides over top of included tray and is tightened with adjustment screws. Optional accessories screw directly into mounting point openings. The two-tier braces allow stacking of platforms with a 10" clearance (available for select sizes). An optional non-skid rubber mat can be placed on the platform for an added non-slip surface. The platform is constructed of type 304 stainless steel.



Description	Used on Shakers	Item No.
11 × 13" (27.9 × 33 cm) Universal Platform	Analog/Digital 16 kg Shakers and Reciprocating Shakers	30400052
13 × 13" (33 × 33 cm) Universal Platform	Analog/Digital 16 kg Shakers and Reciprocating Shakers	30400053
18 × 18" (45.7 × 45.7 cm) Universal Platform*	Analog/Digital 16 kg Shakers and Reciprocating Shakers**	30400054
18 × 24" (45.7 × 61 cm) Universal Platform*	Analog/Digital 16 kg & 23 kg Shakers and Reciprocating Shakers**	30400056
24 × 24" (61 × 61 cm) Universal Platform	Digital 45 kg Shakers	30400057
18 × 30" (45.7 × 76.2 cm) Universal Platform*	Analog/Digital 23 kg Shakers	30400058
24 × 36" (61 × 91.4 cm) Universal Platform	Digital 68 kg Shakers	30400059
Two-Tier Braces (set of 4)	Analog/Digital 16 kg & 23 kg Shakers	30400051

Rubber Mats

Description	Used on Shakers	Item No.
11 × 13" (27.9 × 33 cm) Rubber Mat	Analog/Digital 16 kg Shakers and Reciprocating Shakers	30400060
13 × 13" (33 × 33 cm) Rubber Mat	Analog/Digital 16 kg Shakers and Reciprocating Shakers	30400061
18 × 18" (45.7 × 45.7 cm) Rubber Mat	Analog/Digital 16 kg Shakers and Reciprocating Shakers	30400062
18 × 24" (45.7 × 61 cm) Rubber Mat	Analog/Digital 16 kg Shakers, Reciprocating Shakers and Analog Digital 23kg Shakers	30400063
24 × 24" (61 × 61 cm) Rubber Mat	Digital 45 kg Shakers	30400064
24 × 36" (61 × 91.4 cm) Rubber Mat	Digital 68 kg Shakers	30400065

Culture Platforms

Ideal for slow speed applications; Petri dishes, culture flasks, and other flat bottom, low profile vessels. The two-tier braces (available for both sizes) allow stacking of platforms with a 10" clearance. The platform is constructed of type 304 stainless steel. The platform has a non-skid rubber surface.



Description	Used on Shakers	Item No.
18 × 18" (45.7 × 45.7 cm) Culture Platform*	Analog/ Digital 16 kg Shakers* and Reciprocating Shakers**	30400066
18 × 24" (45.7 × 61 cm) Culture Platform*	Analog/ Digital 16 kg* & 23 kg Shakers and Reciprocating Shakers**	30400067
Two-Tier Braces (set of 4)	Analog/ Digital 16 kg & 23 kg shakers	30400051

*Two-tier ready

**Stacking of platforms is not recommended for Reciprocating Shaker

Open Air , Incubating , Incubating Cooling Shakers Accessories

Dedicated Platforms

Pre-mounted flask clamps for maximum utilization of platform space for flasks of all one size. The two-tier braces allow stacking of platforms with a clearance (available for select sizes). Platform is constructed of type 304 stainless steel. Flask clamps are constructed of PVC. Ideal for polycarbonate flasks.



Description	Flask Capacity	Used on Shakers	Item No.
13 × 13" (33 × 33 cm) Dedicated Platform / 125 mL Flask Clamp	16	Analog/Digital 16 kg Shakers and Reciprocating Shakers	30400075
13 × 13" (33 × 33 cm) Dedicated Platform / 250 mL Flask Clamp	12	Analog/Digital 16 kg Shakers and Reciprocating Shakers	30400076
13 × 13" (33 × 33 cm) Dedicated Platform / 500 mL Flask Clamp	8	Analog/Digital 16 kg Shakers and Reciprocating Shakers	30400077
13 × 13" (33 × 33 cm) Dedicated Platform / 1 L Flask Clamp	4	Analog/Digital 16 kg Shakers and Reciprocating Shakers	30400078
18 × 18" (45.7 × 45.7 cm) Dedicated Platform / 125 mL Flask Clamp*	27	Analog/Digital 16 kg Shakers and Reciprocating Shakers**	30400079
18 × 18" (45.7 × 45.7 cm) Dedicated Platform / 250 mL Flask Clamp*	20	Analog/Digital 16 kg Shakers and Reciprocating Shakers**	30400080
18 × 18" (45.7 × 45.7 cm) Dedicated Platform / 500 mL Flask Clamp*	13	Analog/Digital 16 kg Shakers and Reciprocating Shakers**	30400081
18 × 18" (45.7 × 45.7 cm) Dedicated Platform / 1 L Flask Clamp	9	Analog/Digital 16 kg Shakers and Reciprocating Shakers	30400082
Two-Tier Braces (set of 4)		Analog/Digital 16 kg Shakers	30400051

Adjustable Platforms

Adjustable clamping bars accommodate various vessel types. Constructed of stainless steel. The base tray has a non-skid rubber surface.

Upper slot distance – 4.5" from platform

Lower slot distance – 2 ¼" from platform



Description	Bar Size	Overall Dimensions	Used on Shakers	Item No.
2-bar Adjustable Platform	8.6" (21.8 cm)	8.6 × 11.7" (21.8 × 29.7 cm)	Digital 4 kg Shakers	30400121
4-bar Adjustable Platform	18" (45.7 cm)	18 × 18" (45.7 × 45.7 cm)	Analog/Digital 16 kg Shakers	30400068
4-bar Adjustable Platform	18" (45.7 cm)	18 × 24" (45.7 × 61 cm)	Analog/Digital 23 kg Shakers	30400069

Replacement Parts

Description	Used with Platforms	Item No.
8.6" (21.8 cm) Adjustable Bar (with Mounting Hardware)	30400121	30400122
18" (45.7 cm) Adjustable Bar (with Mounting Hardware)	30400068 & 3040069	30400073

*Two-tier ready

**Stacking of platforms is not recommended for Reciprocating Shaker

Open Air , Incubating , Incubating Cooling Shakers Accessories

Large Vessel Carrier Platforms

Ideal for large sample containers like carboys, jugs and bottles. The platform's high side walls secure samples, has a heavy-duty design and is constructed of stainless steel. The base tray has a non-skid rubber surface.



Description	Bar Size	Overall Dimensions (L x W x H)	Used on Shakers	Item No.
4-bar Large Vessel Carrier Platform	18" (45.7 cm)	30.1 x 18.1 x 13.9" (76.4 x 45.9 x 35.3 cm)	Analog/Digital 23 kg Shakers	30400070
4-bar Large Vessel Carrier Platform	24" (61 cm)	24.4 x 24.3 x 14.2" (61.9 x 61.7 x 36.0 cm)	Digital 45 kg Shakers	30400071
5-bar Large Vessel Carrier Platform	24" (61 cm)	36.9 x 24.3 x 14.2" (93.7 x 61.7 x 36.0 cm)	Digital 68 kg Shakers	30400072

Replacement Part	Used with Carrier	Item No.
18" (45.7 cm) Adjustable Bar (with Mounting Hardware)	30400070	30400073
24" (61 cm) Adjustable Bar (with Mounting Hardware)	30400071 & 30400072	30400074

Separatory Funnel Platform

Holds 3 funnels at once on an 18 x 18" (45.7 x 45.7 cm) platform. Platform can accommodate 500 mL to 2 L separatory funnels and is constructed of stainless steel. Includes platform, clamps and hardware to secure 3 funnels.



Description	Used on Shakers	Item No.
Separatory Funnel Platform 46 X 46 cm	Analog/Digital 16 kg Shakers and Reciprocating Shakers	30400083

Microplate Clamp

Can hold one standard microplate or deep-well plate. Constructed of type 304 stainless steel.



Platform Capacities for Microplate Clamps		
Platform Size	Microplate Clamps	Platform Item No.
11 x 13	4	30400052
13 x 13	6	30400053
18 x 18	12	30400054
18 x 24	18	30400056
18 x 30	21	30400057
24 x 24	24	30400058
24 x 36	36	30400059

Description	Used on Shakers	Item No.
Microplate Clamp	Analog/Digital 16 kg, 23 kg, 45 kg, & 68 kg Shakers	30400104

Open Air , Incubating , Incubating Cooling Shakers Accessories

Universal Harness

Attaches to tray to secure low-profile plates.

Description	Used on Shakers	Item No.
Universal Harness	Digital 4 kg Open Air Orbital Shakers	30400123



Dimpled Mat

Designed to hold centrifuge tubes, vials, culture tubes, and micro-tubes securely in place. Mat can easily be removed for cleaning and transporting of tubes from bench to tray.

Description	Used on Shakers	Item No.
Dimpled Mat, 12.75 × 10" (32.4 × 25.4 cm)	Digital Rocking Shaker	30400140
Dimpled Mat, 11.75 × 8.75" (29.9 × 22.2 cm)	Digital Waving Shaker	30400142
Dimpled Mat, 10 × 7.5" (25.4 × 19.1 cm)	Incubating Rocking Shaker	30400141
Dimpled Mat, 9.25 × 7.25" (23.5 × 18.4 cm)	Incubating Waving Shaker	30400143
Dimpled Mat, 11.75 × 8.75" (29.9 × 22.2 cm)	Open Air 4 kg Orbital Shaker	30400124
Dimpled Mat, 14 × 11" (35.6 × 27.9 cm)	Analog Rocking & Waving Shaker	30400144



Stacking Tray

Easily attaches to the units' included tray to add a second tier for higher capacity applications. Second tier tray mounts 3.5" (8.9 cm) above lower tray. The tray includes hardware and a rubber mat.

Description	Used on Shakers	Item No.
Stacking Tray, 12.75 × 10" (32.4 × 25.4 cm)	Digital Rocking Shaker	30400137
Stacking Tray, 11.75 × 8.75" (29.9 × 22.2 cm)	Digital Waving Shaker	30400138
Stacking Tray, 14 × 11" (35.6 × 27.9 cm)	Analog Rocking Shaker	30400139



Dilution Cup Tray

Constructed of type 304 stainless steel. Holds 24 × 28 mm dilution vials.

Description	Used on Unit	Item No.
1.5 to 2 mL Micro-Tube Rack	Digital 4 kg Open Air Orbital Shakers	30400125



Micro-Tube Rack

Optional 1.5 to 2 mL Micro-Tube Rack attaches to tray to hold up to 70 × 1.5 mL or 2 mL micro-tubes. Tray can accommodate up to 2 micro-tube racks.

Description	Used on Unit	Item No.
Stacking Tray, 12.75 × 10" (32.4 × 25.4 cm)	Digital Open Air and Incubating Microplate Shaker	30400114



Open Air , Incubating , Incubating Cooling Shakers Accessories

Stainless Steel Flask Clamps

Designed to hold Erlenmeyer flasks from 10 mL to 6 L. Constructed of type 302 and 304 stainless steel. Includes hardware for easy attachment to platforms. Flask clamps 50 mL and higher are supplied with a spring to hold the flask in place. The 2.8 L clamp is designed to hold a Fernbach flask. Media bottle clamps feature the same details as flask clamps.

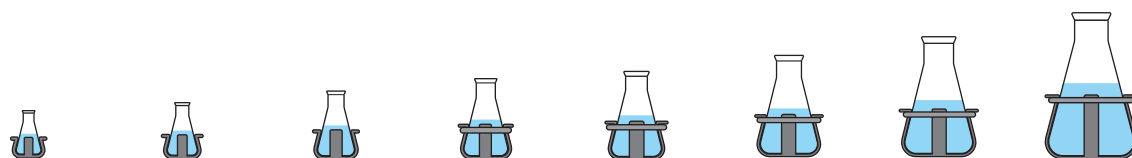

Clamp Style	10 mL Erlenmeyer Flask Clamp	25 mL Erlenmeyer Flask Clamp	50 mL Erlenmeyer Flask Clamp	125 mL Erlenmeyer Flask Clamp	250 mL Erlenmeyer Flask Clamp	500 mL Erlenmeyer Flask Clamp	1 L Erlenmeyer Flask Clamp	2 L Erlenmeyer Flask Clamp
Material	Stainless Steel	Stainless Steel	Stainless Steel	Stainless Steel	Stainless Steel	Stainless Steel	Stainless Steel	Stainless Steel
Item No.	30400084	30400085	30400086	30400087	30400088	30400089	30400090	30400091
Tray or Platform	Number of Flask Clamps per Tray or Platform							
11.75 × 8.75" (29.9 × 22.2 cm) Open Air Digital 4 kg Shakers	35	20	15	12	6	4	N/A	N/A
11 × 7.75" (27.9 × 19.7 cm) Incubating 4 kg Shakers	35	20	12	8	5	N/A	N/A	N/A
11 × 13" (27.9 × 33 cm) Analog/Digital 16 kg Shakers	60	25	13	10	9	7	4	N/A
Digital Reciprocating Shakers	60	25	13	10	9	7	4	N/A
13 × 13" (33 × 33 cm) Analog/Digital 16 kg Shakers	60	30	15	12	12	8	4	3
Digital Reciprocating Shakers	60	30	15	12	12	8	4	3
18 × 18" (45.7 × 45.7 cm) Analog/Digital 16 kg Shakers	113	64	32	20	20	13	8	5
Digital Reciprocating Shakers	113	64	32	20	20	13	8	5
18 × 24" (45.7 × 61 cm) Analog/Digital 16 kg Shakers	158	88	44	28	28	20	12	6
Digital Reciprocating Shakers	158	88	44	28	28	20	12	6
Analog/Digital 23 kg Shakers	158	88	44	28	28	20	12	6
18 × 30" (45.7 × 76.2 cm) Analog/Digital 23 kg Shakers	203	112	56	36	36	26	15	8
24 × 24" (61 × 61 cm) Digital 45 kg Shakers	221	121	61	41	41	25	16	9
24 × 36" (61 × 91.4 cm) Digital 63 kg Shakers	336	160	94	61	64	40	24	14

*All units require a universal platform for mounting flask clamps * test tube racks with the exception of the digital open air and incubating 4 kg shakers

Open Air , Incubating , Incubating Cooling Shakers Accessories

PVC Flask Clamps

Constructed of one piece, molded PVC. Autoclavable. Will not scratch or mark flask like other clamps. Includes hardware for easy attachment to universal platforms. The attachment and removal of flasks is quick and easy. Ideal for polycarbonate flasks.

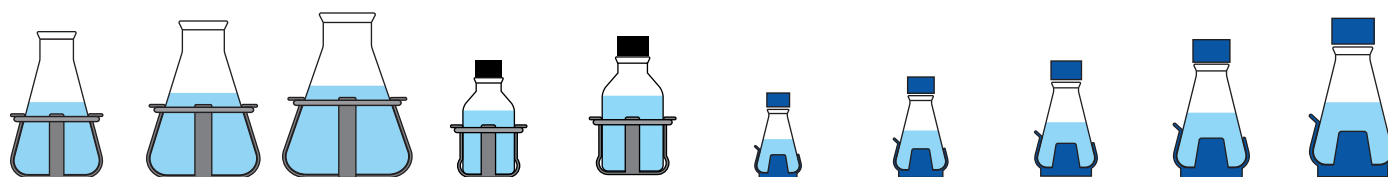

2.8 L & 3 L Fernbach Flask Clamp	4 L Erlenmeyer Flask Clamp	5 L & 6 L Erlenmeyer Flask Clamp	500 mL Media Bottle Clamp	1 L Media Bottle Clamp	125 mL Erlenmeyer Flask Clamp	250 mL Erlenmeyer Flask Clamp	500 mL Erlenmeyer Flask Clamp	1 L Erlenmeyer Flask Clamp	2 L Erlenmeyer Flask Clamp
Stainless Steel	Stainless Steel	Stainless Steel	Stainless Steel	Stainless Steel	PVC	PVC	PVC	PVC	PVC
2.8L-30400092 3L-30400093	30400094	5 L-30400095 6 L-30400096	30400097	30400098	30400099	30400100	30400101	30400102	30400103
Number of Flask Clamps per Tray or Platform									
N/A	N/A	N/A	3	N/A	12	6	4	N/A	N/A
N/A	N/A	N/A	N/A	N/A	8	4	N/A	N/A	N/A
N/A	N/A	N/A	5	2	10	8	5	2	N/A
N/A	N/A	N/A	5	2	10	8	5	2	N/A
1	1	1	6	5	12	10	6	4	3
1	1	1	6	5	12	10	6	4	3
2	4	2	16	10	20	18	12	8	4
2	4	2	16	10	20	18	12	8	4
3	4	3	20	13	28	25	16	10	6
3	4	3	20	13	28	25	16	10	6
3	4	3	20	13	28	25	16	10	6
3	6	4	28	18	36	33	20	14	8
5	5	5	25	18	41	35	24	13	9
7	9	7	40	30	61	55	38	22	13

Open Air , Incubating , Incubating Cooling Shakers Accessories

Test Tube Racks

Half Size, Stationary

Racks constructed of PVC coated steel. Includes hardware for easy attachment to platforms.

Dimensions:

5 L x 7 W x 4" H (12.7 x 17.8 x 10.2 cm) / Micro-Tube Rack: 1.7" H (4.3 cm).



Test Tube Style	1.5 to 2 mL Micro-Tube Rack Half Size, Stationary	10 to 13 mm Test Tube Rack Half Size, Stationary	14 to 16 mm Test Tube Rack Half Size, Stationary	18 to 20 mm Test Tube Rack Half Size, Stationary	22 to 25 mm Test Tube Rack Half Size, Stationary	15 mL Centrifuge Tube Rack Half Size, Stationary	50 mL Centrifuge Tube Rack Half Size, Stationary
Tube Capacity	70	63	48	35	24	35	12
Item No.	30400114	30400115	30400116	30400117	30400118	30400119	30400120
Tray or Platform	Number of Test Tube Racks per Tray or Platform						
11.75 x 8.75" (29.9 x 22.2 cm) Digital Open Air 4 kg Shakers	2	2	2	2	2	2	2
11 x 7.75" (27.9 x 19.7 cm) Incubating 4 kg Shakers	2	1	1	N/A	N/A	1	1
Digital Open Air 4 kg Shakers	2	N/A	N/A	N/A	N/A	N/A	N/A
Incubating Microplate Shakers	2	N/A	N/A	N/A	N/A	N/A	N/A
11 x 13" (27.9 x 33 cm) Analog/Digital 16 kg Shakers	2	2	2	2	2	2	2
Digital Reciprocating Shakers	2	2	2	2	2	2	2
13 x 13" (33 cm x 33 cm) Analog/Digital 16 kg Shakers	2	2	2	2	2	2	2
Digital Reciprocating Shakers	2	2	2	2	2	2	2
18 x 18" (45.7 x 45.7 cm) Analog/Digital 16 kg Shaker	4	4	4	4	4	4	4
Digital Reciprocating Shakers	4	4	4	4	4	4	4
18 x 24" (45.7 x 61 cm) Analog/Digital 16 kg Shakers	6	6	6	6	6	6	6
Digital Reciprocating Shakers	6	6	6	6	6	6	6
Analog/Digital 23 kg Shakers	6	6	6	6	6	6	6
18 x 30" (45.7 x 76.2 cm) Analog/Digital 23 kg Shakers	8	8	8	8	8	8	8
24 x 24" (61 x 61 cm) Digital 45 kg Shakers	8	8	8	8	8	8	8
24 x 36" (61 x 91.4 cm) Digital 63 kg Shakers	7	7	7	7	7	7	7

* All units require a universal platform for mounting flask clamps or test tube racks with the exception of the digital open air and incubating 4 kg shakers

Open Air , Incubating , Incubating Cooling Shakers

Accessories

Test Tube Racks

Full Size, Stationary

Racks constructed of PVC coated steel. Includes hardware for easy attachment to platforms.

Dimensions

3.75 L x 16.5 W x 4" H (9.5 x 41.9 x 10.2 cm)

Full Size, Pivoting

Has adjustable angle, custom tilt. Stainless steel holder includes removable plastic rack. Rack is easily removed to transport from work area to shaker.

Inside pivoting rack dimensions:

5.1 x 10.8 x 3.9" (12.9 x 27.4 x 9.9 cm)

Outside stationary rack dimensions:

5.0 x 10.9 x 5" (12.7 x 27.6 x 12.7 cm)

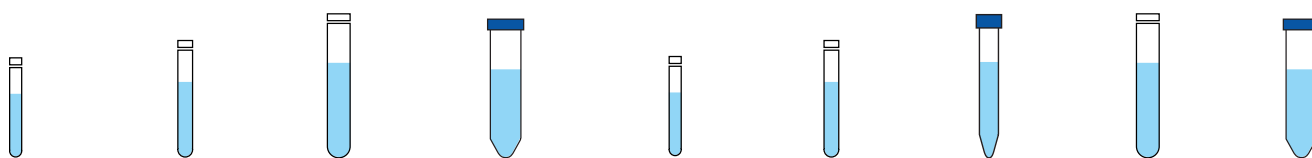

10 to 14 mm Test Tube Rack Full Size, Stationary	16 to 20 mm Test Tube Rack Full Size, Stationary	21 to 25 mm Test Tube Rack Full Size Stationary	50 mL Centrifuge Tube Rack Full Size, Stationary	13 mm Test Tube Rack Full Size, Pivoting	16 mm Test Tube Rack Full Size, Pivoting	20 mm Test Tube Rack Full Size, Pivoting	25 mm Tube Rack Full Size, Pivoting	30 mm Tube Rack Full Size, Pivoting
48	33	21	17	90	60	40	24	21
30400110	30400111	30400112	30400113	30400105	30400106	30400107	30400108	30400109
Number of Test Tube Racks per Tray or Platform								
N/A	N/A	N/A	N/A	N/A	N/A	N/A	N/A	N/A
N/A	N/A	N/A	N/A	N/A	N/A	N/A	N/A	N/A
N/A	N/A	N/A	N/A	N/A	N/A	N/A	N/A	N/A
N/A	N/A	N/A	N/A	1	1	1	1	1
N/A	N/A	N/A	N/A	1	1	1	1	1
N/A	N/A	N/A	N/A	2	2	2	2	2
N/A	N/A	N/A	N/A	2	2	2	2	2
N/A	N/A	N/A	N/A	2	2	2	2	2
N/A	N/A	N/A	N/A	2	2	2	2	2
5	5	5	5	3	3	3	3	3
5	5	5	5	3	3	3	3	3
5	5	5	5	3	3	3	3	3
6	6	6	6	4	4	4	4	4
7	7	7	7	4	4	4	4	4
7	7	7	7	4	4	4	4	4
5	5	5	5	6	6	6	6	6

Fixed Speed Vortex Mixers

- Sturdy design
- Fixed high speed mixing
- Touch mode operation

Built sturdy to provide stable and reliable vortexing action. Starts mixing when the cup head is pressed down. Speed is fixed at full rpm to provide vigorous vortexing of samples.

Operating Conditions:

Unit can be run in conditions from 4 to 40°C (39 to 104°F), 20% to 85% relative humidity, non-condensing.

Ordering Information:

Units include a 3-wire cord and plug. Includes both cup head and 3" head with cover.



Model	Speed Range 120V	Orbit	Controls	Duty Rating	Item No.
VXMNFS	3200 rpm	4.9 mm (0.19")	None	Intermittent duty	30392108

Analog Mini Vortex Mixers

- Sturdy design
- Variable, analog speed control
- Continuous or touch mode operation

Built sturdy to provide stable and reliable vortexing action. Control allows low rpm startup for gentle shaking or high speed mixing for vigorous vortexing of samples. Two modes of operation; continuous mode when using accessory attachments or touch mode which activates mixing when depressing the cup head.

Operating Conditions:

Unit can be run in conditions from 4 to 40°C (39 to 104°F), 20% to 85% relative humidity, non-condensing.

Ordering Information:

Units include a 3-wire cord and plug. Includes both cup head and 3" head with cover. Additional accessories can be found on pages 165-166.



Model	Speed Range* 120V	Orbit	Controls	Duty Rating	Item No.
VXMNAL	300 to 3200 rpm	4.9 mm (0.19")	Auto/Off/On Rocker Switch, Speed Knob: Variable 1 to 10 Dial Marks	Intermittent duty	30392115

* Maximum speed will vary depending on accessory used.

Digital Mini Vortex Mixers

- Sturdy design
- LED displays for speed and time
- Continuous or touch mode operation

Built sturdy to provide stable and reliable vortexing action. Ideal for applications that demand repeatable results. Microprocessor control maintains set speed for strong, consistent mixing action. Timer will display elapsed time or, when programmed to user defined time limit, the unit will shut off when time reaches zero. Two modes of operation; continuous mode when using accessory attachments or touch mode which activates mixing when depressing the cup head.

Operating Conditions:

Unit can be run in conditions from 4 to 40°C (39 to 104°F), 20% to 85% relative humidity, non-condensing.

Ordering Information:

Units include a 3-wire cord and plug. Includes both cup head and 3" head with cover. Additional accessories can be found on pages 165-166.



Model	Speed Range* 120V	Timer	Orbit	Controls	Duty Rating	Item No.
VXMNDG	500 to 3000 rpm	1 second to 160 hours	4.9 mm (0.19")	Auto/Standby/On Rocker Switch, LED Displays for Speed/ Time, Up/Down Buttons for Set-Point Control	Intermittent duty	30392122

* Maximum speed will vary depending on accessory used.

Pulsing Mini Vortex Mixers

- Sturdy design
- LED displays for time and speed
- Glass bead cell disruption/homogenization

Built sturdy to provide stable and reliable vortexing action. Powerful pulsing vortex action produces excellent cell disruption for glass bead procedures. Capable of complete cell disruption of samples in only minutes. Unique pulsing action reduces heat generation while providing more effective mixing and disruption. Displayed time counts up during continuous operation and counts down during timed runs.

Operating Conditions:

Unit can be run in conditions from 4 to 40°C (39 to 104°F), 20% to 85% relative humidity, non-condensing.

Ordering Information:

Units include a 3-wire cord and plug. Includes cup head, 3" head with cover, and an easy-to-load 1.5 mL to 2 mL Micro-Tube Holder. Holder has a built-in cup head. Additional accessories can be found on pages 165-166.



Model	Speed Range* 120V	Timer	Orbit	Controls	Duty Rating	Item No.
VXMNPS	500 to 3000 rpm	1 second to 160 hours	2.5 mm (0.098")	Auto/Standby/On Rocker Switch, LED Displays for Speed/ Time, Up/Down Buttons for Set-Point Control Pulse Button	Intermittent duty	30392129

* Maximum speed will vary depending on accessory used.

Mini Vortex Mixer Accessories

Micro-Tube Holder

Mixes (48) 0.25 to 2 mL micro-tubes.

Requires Insert Retainer.

Description	Item No.
Micro-Tube Holder (2 pack)	30400232
Insert Retainer	30400227

9 to 13 mm Tube Holder

Ideal for mixing 5 mL culture tubes and micro-vials.

Requires Insert Retainer.

Description	Item No.
9 to 13 mm Tube Holder (2 pack)	30400229
Insert Retainer	30400227

14 to 19 mm Tube Holder

Ideal for mixing up to (8) 15 mL centrifuge tubes.

Requires Insert Retainer.

Description	Item No.
14 to 19 mm Tube Holder (2 pack)	30400230
Insert Retainer	30400227

20 to 25 mm Tube Holder

Ideal for mixing up to (8) 50 mL centrifuge tubes.

Requires Insert Retainer

Description	Item No.
20 to 25 mm Tube Holder (2 pack)	30400231
Insert Retainer	30400227

Vessel Harness

Mixes Erlenmeyer flasks and media bottles.

Requires Insert Retainer.

Description	Item No.
Vessel Harness (2 pack)	30400228
Insert Retainer	30400227

Cup Head

Designed for mixing 1 tube at a time.

Description	Item No.
Cup Head	30400235

3" Rubber Head Cover and 3" Head

Designed for mixing irregular shaped objects.

Description	Item No.
3" (7.6 cm) Rubber Head Cover	30400196
3" (7.6 cm) Head	30400236
3" (7.6 cm) Head with Rubber Cover	30400237

Microplate Holder

Ideal for mixing 96-well plates or deep well blocks.

Requires Insert Retainer.

Description	Item No.
Microplate Holder (2 pack)	30400233
Insert Retainer	30400227

Flat Foam Insert

Ideal for custom applications. Can be cut or drilled to fit your specifications. Requires Insert Retainer.

Description	Item No.
Flat Foam Insert (2 pack)	30400234
Insert Retainer	30400227

Microwell Kit with Retainer

Includes:

- 2 Microplate Holders
- 1 Insert Retainer

Description	Item No.
Microwell Kit with Retainer	30400199

Microtube Kit with /Retainer

Includes:

- 2 Micro-Tube Holders
- 1 Insert Retainer

Description	Item No.
Microtube Kit with /Retainer	30400200

Foam Insert Variety Pack

Includes:

- (1) 9 to 13 mm Tube Holder
- (1) 14 to 19 mm Tube Holder
- (1) 20 to 25 mm Tube Holder
- 1 Flat Foam Insert

Description	Item No.
Foam Insert Variety Pack	30400201

Micro-Tube and Microplate Holder Kit

Includes:

- 1 Micro-Tube Holder
- 1 Microplate Holder
- 1 Insert Retainer

Description	Item No.
Micro-Tube & Microplate Holder Kit	30400198

Tube Holder Kit

Includes:

- (1) 9 to 13 mm Tube Holder
- (1) 14 to 19 mm Tube Holder
- (1) 20 to 25 mm Tube Holder
- 1 Flat Foam Insert
- 2 Vessel Harnesses
- 1 Insert Retainer

Description	Item No.
Tube Holder Kit	30400197

OHAUS Vortex Mixer accessories are interchangeable with other manufacturers' models. Call 1-800-672-7722 for assistance.

Mini Vortex Mixer Accessories

Single Tube Holder

Single tube, hands free mixing. Easily attaches to the top of any Vortex Mixer with the use of a strong magnetic base. Accepts tubes from 2.5 to 4.5" (6.4 to 11.4 cm) in length. Minimum tube diameter of 0.75" (19 mm).

Description	Item No.
Single Tube Holder	30400202

Single Tube Holder Accessories

(Requires Single Tube Holder)

0.5 mL Micro-Tube Holder

Mixes (24) 0.5 mL micro-tubes.
For use with Single Tube Holder.

Description	Item No.
Micro-Tube Holder (0.5 mL)	30400204

Ampule Tube Holder

Mixes up to 4 storage vials and test tubes.

Description	Item No.
15 to 17 mm Ampule Tube Holder	30400207
10 to 17 mm Ampule Tube Holder	30400208

Stainless Steel Microtube Holder

Mixes up to (12) 1.5 to 5 mL tubes.
Stainless steel construction.

Description	Item No.
Microtube Holder	30400206

Adapter for Vortex-Genie® Mixer*

Adapter plate easily adheres to the Vortex-Genie® Mixer housing so Single Tube Holder (sold separately) can be attached.

Description	Item No.
Adapter plate	30400203

* The Vortex-Genie® Mixer is a registered trademark of Scientific Industries, Inc.

1.5 mL to 2.0 mL Micro-Tube Holder

Mixes (18) 1.5 to 2 mL micro-tubes.
For use with Single Tube Holder.

Description	Item No.
Microtube Holder (1.5 mL to 2.0 mL)	30400205

Heavy-Duty Vortex Mixers

- Designed for continuous duty
- LED displays for speed and time
- Includes foam insert for 1.5 mL to 2.0 mL microtubes

The OHAUS Digital Heavy-Duty Vortex Mixer is ideal for applications that demand repeatable results. Mixer features touchpad controls and LED displays for accurate speed (rpm) and time (minutes and seconds) results. The heavy-duty design and efficient motor allow this mixer to operate in continuous duty and handle all accessories over the entire speed range. Choose from two modes of operation: "Touch" mode for mixing tubes when cup head or Universal Holder with cover is depressed, or "On" mode when using any of the accessory attachments for continuous operation. Microprocessor control maintains set speed for strong, consistent mixing action. Timer will display elapsed time or, when programmed to user defined time limits, the unit will shut off when time reaches zero.



Operating Features:

Microprocessor Control: The variable speed microprocessor control provides consistent uniform mixing action.

LED Display: Touchpad controls with easy-to-read, independent LED displays for speed and time allow operator to view both settings at once. Provides repeatable and accurate results every time and is easily visible across lab benches. Timer will display elapsed time or, when programmed to user defined limit, will shut off unit when time reaches zero. Display will show last used settings, even after power has been turned off.

Operating Conditions:

Unit can be run in conditions from 4 to 40°C (39 to 104°F), 20% to 85% relative humidity, non-condensing.

Ordering Information:

Mixer includes a cup head, universal holder with cover, foam microtube insert for (38) 1.5 to 2.0 mL microtubes, and a detachable, 3-wire cord and specified plug. Additional accessories can be found on page 171.

Model	Speed Range	Timer	Orbit	Controls	Capacity	Duty Rating	Dimensions (L x W x H)	Item No.
VXHDDG	On Mode 300 to 2500 rpm Touch Mode 300 to 3500 rpm	1 second to 160 hours	4.9 mm (0.19")	Touch/Standby/On Rocker Switch, LED Displays for Speed/Time, Up/Down Buttons for Set-Point Control	2.5 lbs (1.1 kg)	Continuous duty	9.5 x 6.6 x 6.1" (24.1 x 16.8 x 16.5 cm)	30392146

Heavy-Duty Vortex Mixers

- Designed for continuous duty
- Includes foam insert for 1.5 mL to 2.0 mL microtubes
- Heavy-duty design

The OHAUS Analog Heavy-Duty Vortex Mixer is a variable speed analog mixer that is designed for continuous duty. The heavy-duty design and efficient motor allow this mixer to operate in continuous duty and handle all accessories over the entire speed range. Choose from two modes of operation: "Touch" mode for mixing tubes when cup head or Universal Holder with cover is depressed, or "On" mode when using any of the accessory attachments for continuous operation.

Operating Conditions:

Unit can be run in conditions from 4 to 40°C (39 to 104°F), 20% to 85% relative humidity, non-condensing.

Ordering Information:

Mixer includes a cup head, universal holder with cover, foam microtube insert for (38) 1.5 to 2.0 mL microtubes, and a detachable, 3-wire cord and specified plug. Additional accessories can be found on page 171.



Model	Speed Range	Orbit	Controls	Capacity	Duty Rating	Dimensions (L x W x H)	Item No.
VXHDAL	On Mode 300 to 2500 rpm Touch Mode 300 to 3500 rpm	4.9 mm (0.19")	Analog	2.5 lbs (1.1 kg)	Continuous duty	9.5 x 6.6 x 6.1" (24.1 x 16.8 x 16.5 cm)	30392148

Microplate Vortex Mixers

- Designed for continuous duty
- Designed for shaking microplates or tubes
- LED displays for speed and time

The OHAUS Digital Microplate Vortex Mixer is ideal for applications that demand repeatable results. Mixer features touchpad controls and LED displays for accurate speed (rpm) and time (minutes and seconds) results. Microprocessor control maintains set speed for strong, consistent mixing action. Timer will display elapsed time or, when programmed to a user defined time limit, the unit will shut off when time reaches zero. Choose from two modes of operation: "Touch" mode which activates mixing when cup head is depressed, or "On" mode when using the microplate attachments for continuous operation.

Operating Features:

Microprocessor Control: The variable speed microprocessor control provides consistent uniform mixing action.

LED Display: Touchpad controls with easy-to-read, independent LED displays for speed and time allow operator to view both settings at once. Provides repeatable and accurate results every time and is easily visible across lab benches. Timer will display elapsed time or, when programmed to user defined limit, will shut off unit when time reaches zero. Display will show last used settings, even after power has been turned off.

Operating Conditions:

Unit can be run in conditions from 4 to 40°C (39 to 104°F), 20% to 85% relative humidity, non-condensing.

Ordering Information:

Mixer includes a cup head, single microplate holder, and a detachable, 3-wire cord and specified plug. Accessories that can be used on the Microplate Vortex Mixer are cup head, single microplate holder and double microplate holder. Additional accessories can be found on page 171.



Model	Speed Range	Timer	Orbit	Controls	Capacity	Duty Rating	Dimensions (L x W x H)	Item No.
VXMPDG	On Mode 300 to 2500 rpm Touch Mode 300 to 3500 rpm	1 second to 160 hours	3.5 mm (0.13")	Touch/Standby/On Rocker Switch, LED Displays for Speed/Time, Up/Down Buttons for Set-Point Control	2 microplates	Continuous duty	10.5 x 5.4 x 4.5" (26.7 x 13.7 x 11.4 cm)	30392160

Microplate Vortex Mixers

- Designed for continuous duty
- Designed for shaking microplates or tubes
- Optional double microplate holder available

The OHAUS Analog Microplate Vortex Mixer is a variable speed analog mixer that is designed for continuous duty. The high speed and small orbit is optimal for effectively mixing microplates. Choose from two modes of operation: "Touch" mode which activates mixing when cup head is depressed, or "On" mode when using the microplate attachments for continuous operation.

Operating Conditions:

Unit can be run in conditions from 4 to 40°C (39 to 104°F), 20% to 85% relative humidity, non-condensing.

Ordering Information:

Mixer includes a cup head, single microplate holder, and a detachable, 3-wire cord and specified plug. Accessories that can be used on the Microplate Vortex Mixer are cup head, single microplate holder and double microplate holder. Additional accessories can be found on page 171.



Model	Speed Range	Orbit	Controls	Capacity	Duty Rating	Dimensions (L x W x H)	Item No.
VXMPAL	On Mode 300 to 2500 rpm Touch Mode 300 to 3500 rpm	3.5 mm (0.13")	Analog	2 microplates	Continuous duty	10.5 x 5.4 x 4.5" (26.7 x 13.7 x 11.4 cm)	30392162

Heavy Duty and Microplate Vortex Mixer Accessories

Foam Insert for 0.5 mL Microtubes

Foam insert holds (52) 0.5 mL microtubes.

Requires Universal Holder.

Description	Item No.
0.5 mL microtubes	30400216
Universal Holder	30400226

Foam Insert for 1.5 to 2.0 mL Microtubes

Foam insert holds (38) 1.5 to 2.0 mL microtubes.

Requires Universal Holder.

Description	Item No.
1.5 to 2.0 mL microtubes	30400217
Universal Holder	30400226

Foam Insert for 12-13 mm Test Tubes

Foam insert holds (34) 12-13 mm diameter test tubes.

Requires Universal Holder.

Description	Item No.
12-13 mm test tubes	30400220
Universal Holder	30400226

Foam Insert for 15-18 mm Test Tubes

Foam insert holds (20) 15-18 mm diameter test tubes.

Ideal for 15 mL centrifuge tubes.

Requires Universal Holder.

Description	Item No.
15-18 mm test tubes	30400221
Universal Holder	30400226

Foam Insert for 19-21 mm Test Tubes

Foam insert holds (18) 19-21 mm diameter test tubes.

Requires Universal Holder.

Description	Item No.
19-21 mm test tubes	30400222
Universal Holder	30400226

Foam Insert for 22-25 mm Test Tubes

Foam insert holds (13) 22-25 mm diameter test tubes.

Requires Universal Holder.

Description	Item No.
22-25 mm test tubes	30400223
Universal Holder	30400226

Foam Insert for 26-29 mm Test Tubes

Foam insert holds (4) 26-29 mm diameter test tubes. Ideal for 50 mL centrifuge tubes. Requires Universal Holder.

Description	Item No.
26-29 mm test tubes	30400224
Universal Holder	30400226

Cup Head*

Designed for mixing 1 tube at a time.

Description	Item No.
Cup Head	30400210

Small Vessel Holder

Rubber holder secures 125 and 250 mL Erlenmeyer flasks.

Vessel holder also includes a grip mat.

Requires Universal Holder.

Description	Item No.
Small Vessel Holder	30400218
Universal Holder	30400226

Large Vessel Holder

Rubber holder secures 500 and 1000 mL Erlenmeyer flasks.

Vessel holder also includes a grip mat.

Requires Universal Holder.

Description	Item No.
Large Vessel Holder	30400211
Universal Holder	30400226

Microplate Holder (Single)*

Designed to hold one standard microplate.

Description	Item No.
Single Holder	30400215

Microplate Holder (Double)*

Designed to hold two standard microplates.

Description	Item No.
Double Holder	30400213

Microplate Holder (Quad)

Designed to hold four standard microplates.

Description	Item No.
Quad Holder	30400214

Stackable Microplate Holder Four

Designed to maximize the capacity of the Heavy-Duty Vortex Mixer to eight microplates by stacking the tray on top of the four plate holder.

Description	Item No.
Stackable Holder	30400212

Flat Foam Insert

Ideal for custom applications. Can be cut or drilled to fit your specifications. Requires Universal Holder.

Description	Item No.
Flat Foam Insert	30400209
Universal Holder	30400226

Universal Holder & Cover

Replacement for items supplied with Heavy-Duty Vortex Mixer. Cover allows for mixing irregularly shaped objects.

Description	Item No.
Universal Holder	30400226
Universal Holder Cover	30400225

Unless noted with an asterisk (), for use on Heavy-Duty Vortex only.

Multi-Tube Vortex Mixers

- Process up to 50 samples at a time
- Continuous or timed operation
- Includes foam rack for 12 mm tubes

Conveniently angled front panel features rocker switch for run, time and standby modes.

Operating Features:

One piece, stainless steel housing design optimizes clean-ups. Ideal for applications requiring accuracy and repeatability. The stainless steel one piece housing design is conducive to keeping your vortexer clean and free from contaminants.

Microprocessor Control: The variable speed microprocessor control provides consistent uniform mixing action.

Adjustment Knobs: Basic speed and time knobs with 1 to 10 dial markings.

Operating Conditions:

Unit can be run in conditions from 4 to 40°C (39 to 104°F), 20% to 85% relative humidity, non-condensing.

Applications:

Suspensions, high throughput testing in clinical, environmental, and chemistry labs.

Ordering Information:

Unit includes a detachable, 3-wire cord and plug. Unit is also supplied with a Tray Pad Set for support and one 12 mm Test Tube Foam Rack (30400239). Additional accessories can be found on page 174.



Model	Speed Range*	Timer	Orbit	Maximum Weight Capacity	Duty Rating	Tray Dimensions (L x W)	Item No.
VXMTAL	1200 to 2400 rpm	0 to 60 seconds	3.6 mm (0.14")	10 lbs (4.5 kg)	Continuous duty	7.25 x 12.25" (18.4 x 31.1 cm)	30392164

* Maximum speed will vary depending on load.

Multi-Tube Vortex Mixers

- Process up to 50 samples at a time
- LED displays for speed and time
- Pulsing mode

Ideal for applications requiring accuracy and repeatability.

Operating Features:

One piece, stainless steel housing design optimizes clean-ups. Ideal for applications requiring accuracy and repeatability. The stainless steel one piece housing design is conducive to keeping your vortexer clean and free from contaminants.

Microprocessor Control: The variable speed microprocessor control provides consistent uniform mixing action.

LED Display: Touchpad controls with easy-to-read, independent LED displays for speed and time allow operator to view both settings at once. Provides repeatable and accurate results every time and is easily visible across lab benches. Timer will display elapsed time or, when programmed to user defined limit, will shut off unit when time reaches zero. Display will show last used settings, even after power has been turned off.

Pulsing Mode: Programmable pulsing mode allows user to adjust the pulse-on and pulse-off times between 1 and 59 seconds in 1 second intervals. This feature enhances the vortex action by creating a more vigorous mix.

Operating Conditions:

Unit can be run in conditions from 4 to 40°C (39 to 104°F), 20% to 85% relative humidity, non-condensing.

Applications:

Suspensions, high throughput testing in clinical, environmental, and chemistry labs.

Ordering Information:

Unit includes a detachable, 3-wire cord and plug. Unit is also supplied with a Tray Pad Set for support and one 12 mm Test Tube Foam Rack (30400239). Additional accessories can be found on page 174.



Model	Speed Range*	Speed Accuracy	Timer	Orbit	Maximum Weight Capacity	Duty Rating	Tray Dimensions (L x W)	Item No.
VXMTDG	500 to 2500 rpm	± 25 rpm	1 second to 160 hours	3.6 mm (0.14")	10 lbs (4.5 kg)	Continuous duty	7.25 x 12.25" (18.4 x 31.1 cm)	30392171

* Maximum speed will vary depending on load.

Multi-Tube Vortexer Accessories

Foam Test Tube Racks

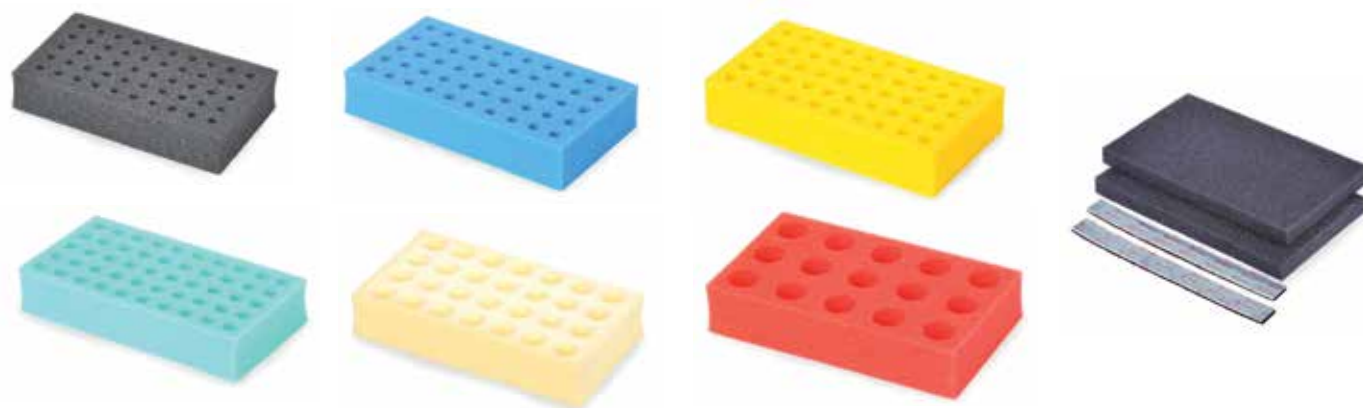

Description	Tube Capacity	Color	Dimensions (L x W x H)	Item No.
10 mm Test Tube Foam Rack	50	Gray	5.5 x 9.5 x 2" (14 x 24.1 x 5.1 cm)	30400238
12 mm Test Tube Foam Rack	50	Blue	5.5 x 9.5 x 2" (14 x 24.1 x 5.1 cm)	30400239
13 mm Test Tube Foam Rack	50	Yellow	5.5 x 9.5 x 2" (14 x 24.1 x 5.1 cm)	30400240
16 mm Test Tube Foam Rack (for 15 mL centrifuge tubes)	50	Green	5.5 x 9.5 x 2" (14 x 24.1 x 5.1 cm)	30400241
25 mm Test Tube Foam Rack	28	White	5.5 x 9.5 x 2" (14 x 24.1 x 5.1 cm)	30400243
29 mm Test Tube Foam Rack (for 50 mL centrifuge tubes)	15	Red	5.5 x 9.5 x 2" (14 x 24.1 x 5.1 cm)	30400242
Replacement Tray Pad Set (upper & lower)	N/A	Gray	7 x 12 x 1" (17.8 x 30.5 x 2.5 cm)	30400245

Post Extension Kit

Adds 6" (15.2 cm) to the post of the Multi-Tube Vortex Mixer to accommodate tubes up to 10" (25.4 cm) tall.

Description	Item No.
Post Extension Kit	30400244



Dry Block Heaters

- Exceptional temperature uniformity and stability
- Optional external temperature probe
- Holds interchangeable modular blocks

Designed for applications that require repeatable results and superior temperature stability. These multi-purpose units are ideal for incubation and activation of cultures, enzyme reactions, immunoassays, melting/boiling points, and a wide variety of other laboratory procedures. Integral support rod holder with locking knob accepts optional External Temperature Probe Kit. Optional External Temperature Probe Kit monitors actual block or sample temperature. Each of the five models accepts separate interchangeable modular blocks, accommodating various tube sizes from 0.2 mL micro-tubes to 50 mL centrifuge tubes. Each block has a thermometer well for measuring block temperature. Efficient heating due to close tube-and-block contact for maximum heat retention. Heaters require OHAUS modular heating blocks for operation. Modular blocks are sold separately (see pages 178 -180).

Operating Features:

Microprocessor Control: PID temperature control, with optional external RTD probe, offers a temperature stability as low as $\pm 0.1^\circ\text{C}$ with a temperature uniformity as low as $\pm 0.1^\circ\text{C}$. Samples are heated to temperature quickly and accurately. Temperature is adjusted in $\pm 0.1^\circ\text{C}$ increments.

LED Display: Touchpad controls with easy-to-read, independent LED displays for temperature, and time. Provides repeatable and accurate results every time and is easily visible across lab benches. Shows set-point and actual temperature. Timer will display elapsed time or, when programmed to user defined limit, will shut off unit when time reaches zero. Display will show last used settings, even after power has been turned off.

Temperature Calibration Mode: Allows user to calibrate unit to an external temperature device.

Safety Features:

Caution Hot Indicator: Hot warning symbol light is illuminated when the temperature is above 40°C .

Overshoot Protection: If the unit exceeds the set temperature by 10°C the unit will automatically stop heating.

Audible Alarm: In timed mode, alarm will sound when time reaches zero and when unit reaches set-point temperature.

CAUTION! To avoid possible electrical hazard, do not fill well or block opening with water or other fluids. Unit is designed as a dry bath/incubator.

Operating Conditions:

Units can be run in conditions from 18 to 33°C (64 to 91°F), 20% to 80% relative humidity, non-condensing.

Applications:

Denaturing proteins, DNA applications, ELISA and other immunoassay studies.

Ordering Information:

Units include a detachable, 3-wire cord and plug. Modular blocks are sold separately (see pages 176 -178).



External Temperature Probe Kit

Enables the unit to read actual block or sample temperature and display that temperature on the control panel. The optional External Temperature Probe Kit includes a stainless steel RTD PT100 probe, 18" (45.7 cm) stainless steel support rod, thermometer/temperature probe extension clamp and hook connector. The PT100 RTD probe is designed to fit perfectly into the thermometer well of each modular block.

Size	Temperature Range	Temperature Stability @ 37°C	Uniformity Within the Block @ 37°C	Uniformity Across Similar Blocks @ 37°C	Heat-Up Time to 100°C	Model	Item No.
1 block	Ambient $+5^\circ\text{C}$ to 120°C	120 volt units: $\pm 0.1^\circ\text{C}$	120 volt units: $\pm 0.1^\circ\text{C}$	N/A	≤ 16 minutes	HB1DG	30392059
2 block				$\pm 0.1^\circ\text{C}$	≤ 16 minutes	HB2DG	30392080
4 block				$\pm 0.2^\circ\text{C}$	≤ 23 minutes	HB4DG	30392087
6 block				$\pm 0.3^\circ\text{C}$	≤ 30 minutes	HB6DG	30392094

Description	Item No.
Optional External Temperature Probe Kit	30400246

Dry Block Heaters

- Multi-purpose use
- Holds interchangeable modular blocks
- Analog controls

High wattage, constant-temperature Dry Block Heaters are economical, versatile and compact. These multi-purpose units are ideal for incubation and activation of cultures, enzyme reactions, immunoassays, melting/boiling points and a wide variety of other laboratory procedures. Each of the five models accept separate interchangeable modular blocks, accommodating various sample enclosures such as microtubes, centrifuge tubes, vials, microplates, and PCR strips or tubes. Each block has a thermometer well for measuring block temperature. Anodized aluminum modular blocks provide superior temperature stability and heat transfer. Heaters require OHAUS modular heating blocks for operation. Modular blocks are sold separately (see pages 178 -180).

Operating Features:

High wattage, constant-temperature Dry Block Heaters are economical, versatile and compact.

Microprocessor Control: PID temperature controller maintains precise temperature control. Samples are heated to temperature quickly and accurately.

Adjustment Knobs: Dual temperature control knobs with dial markings from 1 to 10 for low temperature and high temperature adjustments. Low range knob adjusts from ambient to 100°C and high range knob adjusts from 75°C to 150°C.

CAUTION! To avoid possible electrical hazard, do not fill well or block opening with water or other fluids. Unit is designed as a dry bath/incubator.

Operating Conditions:

Units can be run in conditions from 18 to 33°C (64 to 91°F), 20% to 80% relative humidity, non-condensing.

Applications:

Coagulation and RH Studies.

Ordering Information:

Units include a detachable, 3-wire cord and plug. Modular blocks are sold separately (see pages 176 -178).



Size	Temperature Range	Uniformity Within the Block @ 37°C	Temperature Stability @ 37°C	Uniformity Across Similar Blocks @ 37°C	Heat-Up Time to 100°C	Model	Item No.
1 block	Low Range: Ambient +5°C to 100°C High Range: 75°C to 150°C	120 volt units: ± 0.1°C	120 volt units: ± 1.0°C	N/A	≤ 16 minutes	HB1AL	30392045
2 block			120 volt units: ± 1.5°C	± 0.1°C	≤ 16 minutes	HB2AL	30392052
4 block			120 volt units: ± 2.0°C	± 0.2°C	≤ 23 minutes	HB4AL	30392066
6 block			± 0.3°C	± 0.3°C	≤ 30 minutes	HB6AL	30392073

2 Block Dry Block Heater with Lid

- Exceptional uniformity, stability, and regulation of temperature
- Heated lid reduces condensation on sample lids
- Optional external temperature probe

OHAUS Digital Dry Block Heater with Heated Lid are designed for applications that require repeatable results and superior temperature stability. These multi-purpose units are ideal for isothermal incubation, enzyme reactions, immunoassays, nucleic acid denaturation and a wide variety of other laboratory procedures. Integral support rod holder with locking knob accepts optional External Temperature Probe Kit. Optional External Temperature Probe Kit monitors actual block or sample temperature. Block heater accepts one microplate block or two separate interchangeable modular blocks, accommodating various tube sizes from 0.2 mL micro-tubes to test tubes or vials up to 85 mm in height. Each block has a thermometer well for measuring block temperature. Efficient heating due to close tube-and-block contact with a low density design for exceptional temperature uniformity. The heated lid helps to regulate the temperature and reduce the amount of condensation on sample lids. Heaters require OHAUS modular heating blocks for operation. Modular blocks are sold separately (see pages 178 -180).

Operating Features:

Microprocessor Control: PID temperature control, with optional external RTD probe, offers a temperature stability as low as $\pm 0.1^{\circ}\text{C}$ with a temperature uniformity as low as $\pm 0.1^{\circ}\text{C}$. Samples are heated to temperature quickly and accurately. Temperature is adjusted in $\pm 0.1^{\circ}\text{C}$ increments.

LED Display: Touchpad controls with easy-to-read, independent LED displays for temperature, and time. Provides repeatable and accurate results every time and is easily visible across lab benches. Shows set-point and actual temperature. Timer will display elapsed time or, when programmed to user defined limit, will shut off unit when time reaches zero. Display will show last used settings, even after power has been turned off.

Temperature Calibration Mode: Allows user to calibrate unit to an external temperature device.

Safety Features:

Caution Hot Indicator: Hot warning symbol light is illuminated when the temperature is above 40°C .

Overshoot Protection: If the unit exceeds the set temperature by 10°C the unit will automatically stop heating.

Audible Alarm: In timed mode, alarm will sound when time reaches zero and when unit reaches set-point temperature.

CAUTION! To avoid possible electrical hazard, do not fill well or block opening with water or other fluids. Unit is designed as a dry bath/incubator.

Operating Conditions:

Units can be run in environments from 18 to 33°C (64 to 91°F), 20% to 80% relative humidity, non-condensing.

Applications:

Isothermal incubation, enzyme reactions, immunoassays and nucleic acid denaturation and a wide variety of other laboratory procedures.

Ordering Information:

Units include a detachable, 3-wire cord and plug. For optional temperature probe kits see page 175. Modular blocks sold separately (see pages 178 -180).



Model	Size	Temperature Range	Temperature Stability @ 37°C	Uniformity Within the Block @ 37°C	Uniformity Across Similar Blocks @ 37°C	Heat-Up Time to 100°C	Item No.
HB2DGHL	2 block	Ambient $+5^{\circ}\text{C}$ to 100°C	120 volt units: $\pm 0.1^{\circ}\text{C}$	120 volt units: $\pm 1.0^{\circ}\text{C}$	$\pm 0.1^{\circ}\text{C}$	≤ 30 minutes	30392101

Modular Blocks & Accessories

Modular blocks are constructed from a solid anodized aluminum block*. The close contact of tubes-to-block walls allow for maximum heat retention. Each block has a thermometer well for measuring block temperature.

CAUTION! To avoid possible electrical hazard, do not fill well or block with water or other fluids. Units are designed as a dry bath/incubator.

Single block dimensions (L × W × H): 3.75 × 3 × 2" (9.5 × 7.6 × 5.1 cm)

Double block dimensions (L × W × H): 6 × 3.75 × 2.25" (15.2 × 9.5 × 5.7 cm)



Microcentrifuge Tube Blocks

Single block

Brand/Sample Type	No. of Wells	Well Dia.	Well Depth	Item No.
0.5 mL Tube	30	7.9 mm	27.6 mm	30400157
1.5 mL Tube	20	11.1 mm	39.1 mm	30400159
1.5 mL Eppendorf™ Tube	20	11.5 mm	36.9 mm	30400162
2 mL Eppendorf™ Tube	20	11.5 mm	38.1 mm	30400191
2 mL Corning™ Tube	20	10.9 mm	38.1 mm	30400192

Titer Plate Block

Double block

Fits 2/4/6 block Dry Block Heaters. Ideal for 96-well or 384-well titer plates. Recessed well for better stability, flat surface good for flat and round bottom plates.

Sample Type	Well Depth	Item No.
Titer Plate	13.5 mm	30400164

Conical-Bottom Centrifuge Tube Blocks

Single/Sample Type	No. of Wells	Well Dia.	Well Depth	Item No.
15 mL Tube	12	17.1 mm	44.5 mm	30400172
50 mL Tube	5	29.0 mm	47.6 mm	30400168

Standard Test Tube Blocks

Single/Sample Type	No. of Wells	Well Dia.	Well Depth	Item No.
6 mm Tube	30	8.3 mm	48.4 mm	30400158
10 mm Tube	24	10.7 mm	48.4 mm	30400151
12/13 mm Tube	20	13.9 mm	48.4 mm	30400152
12/13 mm Tube	16	13.9 mm	48.4 mm	30400165
15/16 mm Tube	12	17.5 mm	48.4 mm	30400153
17/18 mm Tube	12	19.1 mm	48.4 mm	30400195
20 mm Tube	8	21.0 mm	48.4 mm	30400154
25 mm Tube	6	26.2 mm	48.4 mm	30400155
35 mm Tube	4	35.0 mm	47.6 mm	30400167

* Block color subject to change

Modular Blocks* & Accessories

Combination Blocks

Single block

These blocks have been designed for variable sized samples.

Sample Type		No. of Wells	Well Dia.	Well Depth	Item No.
Test Tube Combination	6 mm	6	8.3 mm	48.4 mm	30400156
	12/13 mm	5	13.8 mm	48.4 mm	
	25 mm	3	26.2 mm	48.4 mm	
Centrifuge Tube Combination	1.5 mL	4	11.1 mm	39.1 mm	30400193
	15 mL	3	17.1 mm	44.5 mm	
	50 mL	2	29.0 mm	47.6 mm	
Micro-Tube Combination	0.5 mL	6	7.9 mm	27.6 mm	30400194
	1.5 mL	10	11.1 mm	39.1 mm	
	2 mL	5	11.5 mm	38.1 mm	



Vial Blocks

Single block

Designed for sample/serum and scintillation vials.

Sample Type	No. of Wells	Well Dia.	Well Depth	Item No.
12 mm Vial	20	12.7 mm	30 mm	30400182
15 mm Vial	20	15.8 mm	35 mm	30400183
16 mm Vial	15	16.4 mm	45 mm	30400190
17 mm Vial	12	17.8 mm	45 mm	30400184
19 mm Vial	12	19.7 mm	45 mm	30400185
21 mm Vial	9	21.7 mm	45 mm	30400186
23 mm Vial	8	23.8 mm	45 mm	30400187
25 mm Vial	8	25.8 mm	45 mm	30400188
28 mm Vial	6	28.8 mm	45 mm	30400189



PCR—Plate, Tube, Strip Blocks

Single and double block

Tapered tube wells for 0.2 mL tubes. Spaced for easy access and removal.

Sample Type	Block Size	No. of Wells	Well Dia.	Well Depth	Item No.
96-well PCR Plate	Double	96	6.4 mm	15.5 mm	30400171
10 × 8 Tube Strips	Single	80	6.4 mm	15.5 mm	30400169
Individual Tubes	Single	64	6.4 mm	20.2 mm	30400170



Cuvette Block

Single block

Two parallel slots fit 6 cuvettes in each slot, side-by-side.

Sample Type	No. of Wells	Well Depth	Item No.
(12) 12.5 mm Cuvettes	2	25.4 mm	30400161



* Block color subject to change

Modular Blocks* & Accessories

Solid Blocks

Single and double block

For use as a low-temperature hotplate, slide drying, or for custom drilling to make a custom block.

Block Size	Dimensions (L × W × H)	Item No.
Single	3.75 × 3 × 2" (9.5 × 7.6 × 5.1 cm)	30400160
Double	6 × 3.75 × 2.25" (15.2 × 9.5 × 5.7 cm)	30400166



Stainless Steel Sand Baths

Ideal for irregular vessels. Stainless steel construction for superior corrosion resistance. Designed to hold sand, stainless steel shot or non-volatile fluids.

For Unit	Dimensions (L × W × H)	Item No.
1 Block Dry Block Heater	3.8 × 3.0 × 2.5" (9.5 × 7.6 × 6.4 cm)	30400173
2 Block Dry Block Heater	3.8 × 5.9 × 2.5" (9.5 × 14.9 × 6.4 cm)	30400174
4 Block Dry Block Heater	5.8 × 7.5 × 2.5" (14.7 × 19.1 × 6.4 cm)	30400175
6 Block Dry Block Heater	5.8 × 11.3 × 2.5" (14.7 × 28.7 × 6.4 cm)	30400176



Accessories	Item No.
Sand, 1 lb (0.45 kg)	30400177
Stainless Steel Shot, 1 lb (0.45 kg)	30400178

Low Temperature Covers

Plexiglass cover reduces air flow for additional temperature stability in low-temperature applications. Two sides are open 0.25" (6.4 mm).

Block Size	Dimensions (L × W × H)	Item No.
2 Block Cover	6.5 × 6.5 × 1.6" (16.5 × 16.5 × 4.1 cm)	30400179
4 Block Cover	8.5 × 8.5 × 1.6" (21.6 × 21.6 × 4.1 cm)	30400180
6 Block Cover	12.5 × 8.5 × 1.6" (31.8 × 21.6 × 4.1 cm)	30400181



* Block color subject to change

Mini Hotplates & Stirrers

- Ergonomic design
- Hotplates & Hotplate-Stirrers boil 300 mL of water in 18 minutes
- Ideal for educational labs
- Built in support rod holder

The OHAUS Basic Mini Hotplates, Stirrers, and Hotplate-Stirrers are rugged, compact units that heat and stir up to 1000 mL of liquid. Ceramic tops feature a chemical resistant white reflective top plate that is easy to clean. Bi-metallic thermostat offers reliable temperature control. Powerful heater reaches maximum temperature in only minutes. Powerful motor and magnet deliver reliable and consistent stirring. Compact design saves bench space. Built-in support rod holder with locking knob accepts optional Support Rod and Clamp Kit.

Basic Mini Fixed Temperature Hotplate features an illuminated rocker switch to activate the preset fixed temperature of 500°C.

Basic Mini Auto-Stirrer is automatically activated by the minimum weight of a beaker or flask and will stop stirring when mixing vessel is removed.

Operating Features:

Adjustment Knobs: Basic speed and temperature control knobs with dial markings from 1 to 10.

Operating Conditions:

Units can be run in conditions from 5 to 40°C (41 to 104°F), 20% to 85% relative humidity, non-condensing.

Applications:

Academia and basic chemistry.

Ordering Information:

Units include a 3-wire cord and plug. Stirrers and Hotplate-Stirrers are supplied with a 1.5" (3.8 cm) PTFE coated stir bar.



Basic Mini Hotplates

Model	Temperature Range	Maximum Capacity (H ₂ O)	Top Plate Dimensions (Dia.)	Overall Dimensions (L × W × H)	Item No.
HSMNHP4CAL	to 500°C*	1000 mL	4 × 4" (10.2 × 10.2 cm)	7.9 × 6 × 5" (20.1 × 15.2 × 12.7 cm)	30392010
HSMNHP4CFT*					30392031

* Fixed Temperature Hotplate has a fixed temperature of 500°C.

Basic Mini Stirrers

Model	Speed Range	Maximum Capacity (H ₂ O)	Top Plate Dimensions (Dia.)	Overall Dimensions (L × W × H)	Item No.
HSMNST4CAL	100 to 1200 rpm	1000 mL	4 × 4" (10.2 × 10.2 cm)	7.9 × 6 × 5" (20.1 × 15.2 × 12.7 cm)	30392017
HSMNAS4CAL**					30392038

**Mini auto stirrer

Basic Mini Hotplate-Stirrers

Model	Temperature Range	Speed Range	Maximum Capacity (H ₂ O)	Top Plate Dimensions (Dia.)	Overall Dimensions (L × W × H)	Item No.
HSMNHS4CAL	to 500°C	100 to 1200 rpm	1000 mL	4 × 4" (10.2 × 10.2 cm)	7.9 × 6 × 5" (20.1 × 15.2 × 12.7 cm)	30392024

HT Lysing Bead Mill Homogenizer

- Flexibility to handle multiple samples & tube configurations
- Take the guesswork out of determining optimum speed/time with 5 pre-set programs
- Increased efficiency with high-throughput sample processing
- Integral lid lock for increased safety

The HT (High Throughput) Lysing Bead Mill Lab Homogenizer offers efficient solutions for all of your grinding, lysing, pulverizing, mixing and homogenizing sample preparation applications. High-throughput processing is ideal for multiple sample and tube configurations. Easy-to-load tray securely locks the microplate or tube in place. High speed linear motion processes samples quickly. Flexibility to use OHAUS sample tubes or any other brand.

Operating Features:

LED display: Allows the operator to view speed and time settings

Microprocessor-control: Unit includes sample clamp and hex key

Applications: DNA, RNA and Protein Analysis (from mammalian tissue, plant, soil, seed, fungi, bacteria, virus and other cells), Cell Lysing, PCR, Gene Expression



Model	Speed Range	Motion	Timer	Capacity	Maximum Capacity	Item No.
HOHTDG	300 to 1600 rpm (1 rpm increments)	Reciprocal, 31 mm	1 second to 10 minutes (1 second increments)	1 deep well plate, 4 microplates, or any sample matrix that can fit in the 10.2 × 12.7 × 6.4 cm adjustable holder	300 g	30391393

Bead Mill Homogenizer Tubes, Racks & Kits



Accessories	Item No.
White, Bacteria, 2mL tube, 100/box	30391402
Yellow, Yeast, 2mL Tube, 100/box	30391404
Blue, Fungi, 2mL Tube, 100/box	30391405
Orange, Soft Sample, 2mL Tube, 100/box	30391406
Green, Plant, 2mL Tube, 100/box	30391408
Red, Animal Tissue, 2mL Tube, 100/box	30391409
Brown, Environmental, 2mL Tube, 100/box	30391410
Tube Rack, 25 x 2ml Tubes, 2 per pack	30391431
Sample Tube Kit, 14 Tubes	30391433

Multi-Purpose Clamps

UltraJaws Heavy-Duty Clamps

- Large grip adjustment range
- Single or dual adjust
- Available in three sizes; small, medium, and large
- Nickel-plated zinc

Our patented multi-purpose UltraJaws Heavy-Duty Clamps feature an innovative closed yoke construction that minimizes contamination and corrosion of internal components. The unique design enables secure gripping and positioning with added strength and durability.

Available in both single and dual prong adjustment, prongs open gradually to maximize grip size without binding. Both designs feature precise pressure regulation when gripping glassware surfaces to reduce the chance of breakage. UltraJaws clamps are constructed with extension rods for easy attachment to lab-frames and other apparatus. Supplied with non-slip vinyl sleeves and, for temperatures above 100°C, fiberglass covers.

The prong height of the UltraJaws Heavy-Duty Clamps make them ideal for use in holding and securing glassware with precision ground glass joints. The chart details which UltraJaws Clamps are recommended.

NOTE: An additional holder must be purchased in order to attach clamps to frames or other apparatus.

See the Connectors & Holders section of this catalog, pages 195 - 197.

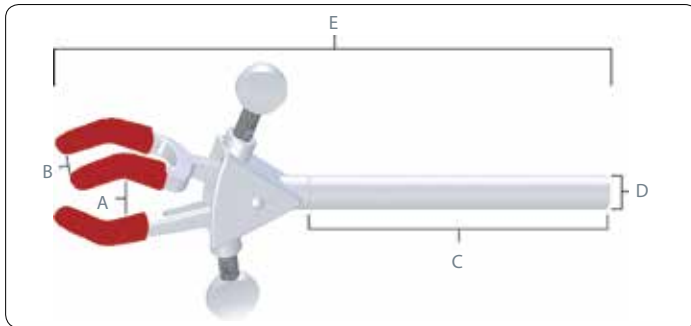

Ground Glass Joint Reference Chart

Clamp	Joint Size
Small Dual Adjust	10/30, 12/30, 14/20, 19/22, 24/40, 29/42, 34/45
Medium Dual Adjust	14/40, 19/38
Large Dual Adjust	45/50

3-Prong Single Adjust Clamps

Size	(A) Min. to Max Grip Size	(B) Prong Width	(C) Arm Length	(D) Arm Dia.	(E) Overall Length	Item No.
Small	0 to 23 mm (0 to 0.91")	6 mm (0.24")	102 mm (4")	8 mm (0.32")	162 mm (6.38")	30392254
Medium	0 to 50 mm (0 to 1.97")	19 mm (0.75")	127 mm (5")	11 mm (0.43")	229 mm (9.02")	30392252
Large	0 to 72 mm (0 to 2.83")	29 mm (1.14")	127 mm (5")	11 mm (0.43")	260 mm (10.24")	30392250

3-Prong Dual Adjust Clamps

Size	(A) Min. to Max Grip Size	(B) Prong Width	(C) Arm Length	(D) Arm Dia.	(E) Overall Length	Item No.
Small	0 to 32 mm (0 to 1.26")	6 mm (0.24")	102 mm (4")	8 mm (0.32")	152 mm (5.98")	30392253
Medium	0 to 70 mm (0 to 2.76")	19 mm (0.75")	127 mm (5")	11 mm (0.43")	222 mm (8.74")	30392251
Large	0 to 103 mm (0 to 4.06")	29 mm (1.14")	127 mm (5")	11 mm (0.43")	260 mm (10.24")	30392249

Single Adjust Clamps



Dual Adjust Clamps



Multi-Purpose Clamps

Heavy-Duty Tapered Clamps

Heavy-Duty, 4-prong, dual adjust tapered clamps are designed to hold large vessels with ground glass joint necks. Clamps are constructed with extension rods for easy attachment to lab-frames and other apparatus. Nickel-plated zinc construction.

NOTE: An additional holder must be purchased in order to attach clamps to frames or other apparatus.

See the Connectors & Holders section of this catalog, pages 195 - 197.



30392194



30392193

Size	Joint Size	Prong Width	Arm Length	Arm Dia.	Overall Length	Item No.
Small	24/40 mm	16 mm (0.63")	229 mm (9.02")	13 mm (0.51")	356 mm (14")	30392193
Large	34/45 mm	19 mm (0.75")	229 mm (9.02")	13 mm (0.51")	381 mm (15")	30392194

Multi-Purpose Clamps

- Stainless steel, electro-polished finish
- Large dual adjustment range
- Available in three sizes; small, medium, and large

These durable, multi-purpose clamps are made entirely of stainless steel with an electro-polished finish and offer excellent chemical resistance and overall strength. The versatile 3-prong design secures various lab apparatus such as jointed glassware, columns, flasks, and tubes. Dual prong adjustments offer a wide range of motion. Long stainless steel extension arm offers easy positioning and depth adjustment. Autoclavable. Supplied with non-slip vinyl sleeves and, for temperatures above 100°C, fiberglass covers.

NOTE: An additional holder must be purchased in order to attach clamps to frames or other apparatus.

See the Connectors & Holders section of this catalog, pages 195 - 197.



30392352



30392353



30392354

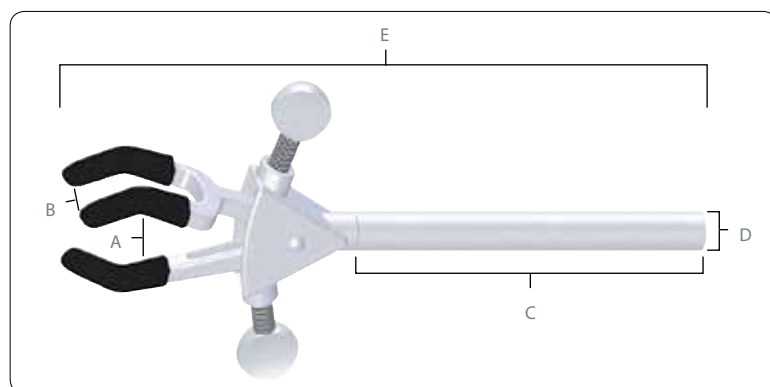

3-Prong Stainless Steel Dual Adjust Clamps

Size	(A) Min. to Max Grip Size	(B) Prong Width	(C) Arm Length	(D) Arm Dia.	(E) Overall Length	Item No.
Small	0 to 48 mm (0 to 1.9")	13 mm (0.51")	102 mm (4")	10 mm (0.39")	172 mm (6.77")	30392354
Medium	0 to 69 mm (0 to 2.72")	19 mm (0.75")	127 mm (5")	13 mm (0.51")	229 mm (9.02")	30392353
Large	0 to 102 mm (0 to 4")	29 mm (1.14")	127 mm (5")	13 mm (0.51")	273 mm (10.75")	30392352

Multi-Purpose Clamps

3-Prong Multi-Purpose Clamps

- Large grip adjustment range
- 3-prong construction
- Single or dual adjust
- Nickel-plated zinc

Designed to securely hold every type of laboratory glassware and apparatus. Long, seamless nickel-plated brass tubing attaches clamp head securely and offers easy positioning in the deepest fume hoods. Clamps are constructed with round extension arms, which allow the clamps to be rotated 360°. Extension arms also allow placement of apparatus at various distances from lab-frames without compromising the integrity of your experiment. Supplied with non-slip vinyl sleeves and, for temperatures above 100°C, fiberglass covers.

NOTE: An additional holder must be purchased in order to attach clamps to frames or other apparatus. See the Connectors & Holders section of this catalog, pages 195 - 197.

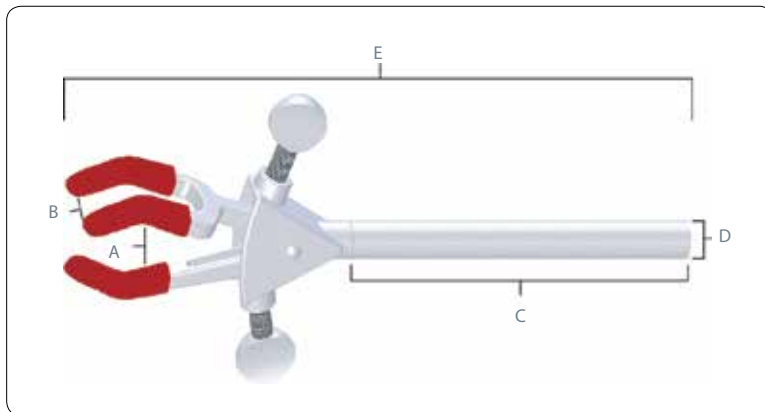

3-Prong Single Adjust Clamps



3-Prong Dual Adjust Clamps

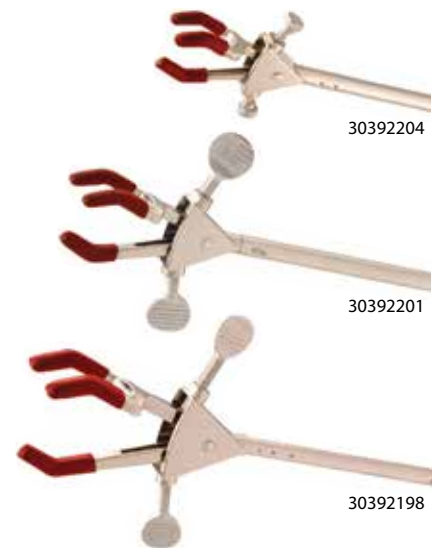

3-Prong Single Adjust Clamps

Size	(A) Min. to Max Grip Size	(B) Prong Width	(C) Arm Length	(D) Arm Dia.	(E) Overall Length	Item No.
Small	0 to 39 mm (0 to 1.54")	11 mm (0.43")	102 mm (4")	8 mm (0.32")	160 mm (6.3")	30392205
Medium	0 to 71 mm (0 to 2.8")	19 mm (0.75")	127 mm (5")	11 mm (0.43")	218 mm (8.58")	30392203
Large	0 to 108 mm (0 to 4.25")	29 mm (1.14")	127 mm (5")	11 mm (0.43")	248 mm (9.76")	30392200

3-Prong Dual Adjust Clamps

Size	(A) Min. to Max Grip Size	(B) Prong Width	(C) Arm Length	(D) Arm Dia.	(E) Overall Length	Item No.
Small	0 to 46 mm (0 to 1.81")	11 mm (0.43")	102 mm (4")	8 mm (0.32")	168 mm (6.61")	30392204
Medium	0 to 69 mm (0 to 2.72")	19 mm (0.75")	127 mm (5")	11 mm (0.43")	229 mm (9.02")	30392201
Medium (extended)	0 to 69 mm (0 to 2.72")	19 mm (0.75")	305 mm (12")	13 mm (0.5")	406 mm (16")	30392202
Large	0 to 105 mm (0 to 4.13")	29 mm (1.14")	127 mm (5")	11 mm (0.43")	273 mm (10.75")	30392198
Large (extended)	0 to 105 mm (0 to 4.13")	29 mm (1.14")	305 mm (12")	13 mm (0.5")	451 mm (17.76")	30392199

Multi-Purpose Clamps

2-Prong Multi-Purpose Clamps

- Stainless steel electro-polished finish or nickel-plated zinc
- Large grip adjustment range
- 2-prong construction
- Single or dual adjust

Designed to securely hold laboratory glassware and apparatus. Extension arm attaches clamp head securely and offers easy positioning in the deepest fume hoods. Clamps are constructed with round extension arms, which allow the clamps to be rotated 360°. Extension arms also allow placement of apparatus at various distances from lab-frames without compromising the integrity of your experiment. Stainless steel clamps are electro-polished and made entirely of stainless steel. They offer exceptional chemical resistance and are autoclavable. Nickel-plated zinc offers a clamp with a high tensile strength at an economical price. Supplied with non-slip vinyl sleeves and, for temperatures above 100°C, fiberglass covers.

NOTE: An additional holder must be purchased in order to attach clamps to frames or other apparatus. See the Connectors & Holders section of this catalog, pages 195 - 197.

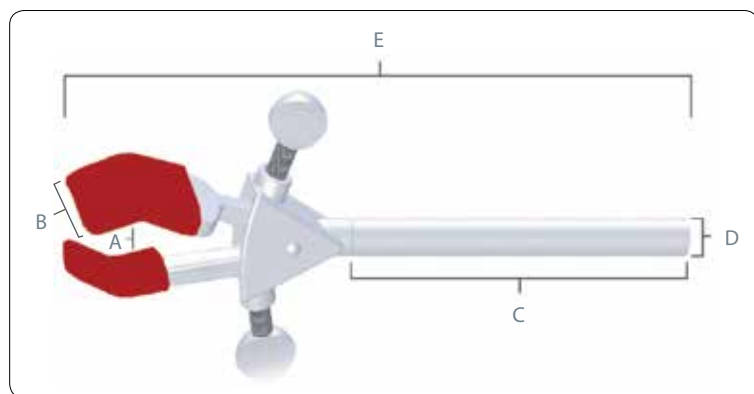

2-Prong Single Adjust Clamps



2-Prong Dual Adjust Clamps

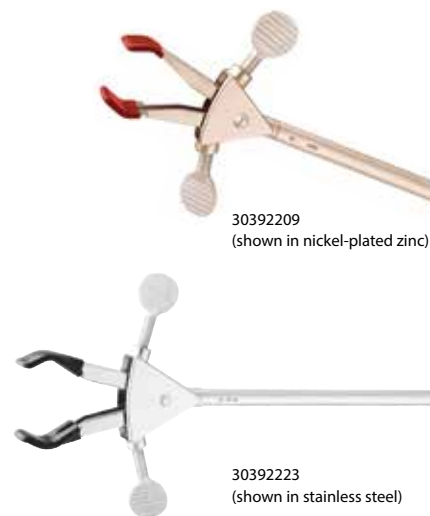

2-Prong Single Adjust Clamps

Material	Size	(A) Min. to Max Grip Size	(B) Prong Width	(C) Arm Length	(D) Arm Dia.	(E) Overall Length	Item No.
Nickel-plated zinc	Medium	0 to 78 mm (0 to 3.07")	23 mm (0.91")	127 mm (5")	11 mm (0.43")	216 mm (8.5")	30392208
Nickel-plated zinc	Large	0 to 92 mm (0 to 3.62")	23 mm (0.91")	127 mm (5")	11 mm (0.43")	229 mm (9.02")	30392206

2-Prong Dual Adjust Clamps

Material	Size	(A) Min. to Max Grip Size	(B) Prong Width	(C) Arm Length	(D) Arm Dia.	(E) Overall Length	Item No.
Stainless steel	Medium	0 to 75 mm (0 to 2.95")	23 mm (0.91")	127 mm (5")	11 mm (0.43")	229 mm (9.02")	30392220
Nickel-plated zinc	Medium	0 to 75 mm (0 to 2.95")	23 mm (0.91")	127 mm (5")	11 mm (0.43")	229 mm (9.02")	30392209
Stainless steel	Large	0 to 95 mm (0 to 3.74")	23 mm (0.91")	127 mm (5")	11 mm (0.43")	248 mm (9.76")	30392223
Nickel-plated zinc	Large	0 to 95 mm (0 to 3.74")	23 mm (0.91")	127 mm (5")	11 mm (0.43")	248 mm (9.76")	30392207

Multi-Purpose Clamps

Swivel Clamps

Used to hold apparatus near the lab-frame. Unlike extension clamps, the swivel clamps have an integral holder for attaching to a lab-frame or other apparatus. Built-in holder grips rods up to 19 mm (0.75") in diameter and is adjustable for forward or reverse-facing adjustment screws. Shaft wing-nut allows the holding angle of the swivel clamp to adjust through 360° of rotation and can be locked in place once desired position is achieved. Stainless steel electro-polished finish or nickel-plated zinc construction. Supplied with non-slip vinyl sleeves and, for temperatures above 100°C, fiberglass covers.



Material	Description	Size	Min. to Max. Grip Size	Prong Width	Overall Length	Item No.
Stainless steel	2-Prong Single Adjust	Medium	0 to 76 mm (0 to 3")	23 mm (0.91")	163 mm (6.42")	30392226
Nickel-plated zinc	2-Prong Single Adjust	Medium	0 to 76 mm (0 to 3")	23 mm (0.91")	163 mm (6.42")	30392215
Nickel-plated zinc	2-Prong Single Adjust	Large	0 to 95 mm (0 to 3.74")	23 mm (0.91")	180 mm (7.09")	30392216
Stainless steel	3-Prong Dual Adjust	Medium	0 to 69 mm (0 to 2.72")	20 mm (0.79")	178 mm (7.01")	30392225
Nickel-plated zinc	3-Prong Dual Adjust	Medium	0 to 69 mm (0 to 2.72")	20 mm (0.79")	178 mm (7.01")	30392214

Fixed-Position Clamps

Used to hold apparatus near the lab-frame where no adjustment is required after set-up. Built-in holder grips rods up to 19 mm (0.75") in diameter Fixed-Position Clamps have an integral holder but can be rotated after attachment to a lab-frame or other apparatus. Available in 2-prong or 3-prong. Stainless steel electro-polished finish or nickel-plated zinc construction. Supplied with non-slip vinyl sleeves and, for temperatures above 100°C, fiberglass covers.



Material	Description	Size	Min. to Max. Grip Size	Prong Width	Overall Length	Item No.
Stainless steel	2-Prong Single Adjust	Medium	0 to 77 mm (0 to 3.03")	23 mm (0.91")	133 mm (5.24")	30392230
Nickel-plated zinc	2-Prong Single Adjust	Medium	0 to 77 mm (0 to 3.03")	23 mm (0.91")	133 mm (5.24")	30392218
Stainless steel	3-Prong Dual Adjust	Medium	0 to 69 mm (0 to 2.72")	20 mm (0.79")	146 mm (5.75")	30392229
Nickel-plated zinc	3-Prong Dual Adjust	Medium	0 to 69 mm (0 to 2.72")	20 mm (0.79")	146 mm (5.75")	30392217

Specialty Clamps

Thermometer Swivel Clamp

Holds glass tubes and thermometers 114 mm (4.49") from support rod. Clamp features safety adjust spring plate jaws that adjust to any angle with locking wing-nut. Built-in holder grips rods up to 19 mm (0.75") in diameter. Lightweight, rust, and corrosion-resistant. Nickel-plated construction.

Min. to Max. Grip Size	Overall Length	
6 to 8 mm (0.24 to 0.32")	159 mm (6.26")	



Thermometer / Thermocouple Extension Clamp

Lightweight clamp holds glass tubing, thermometers or thermocouples up to 178 mm (7") from support rod. Tightening wing-nut applies tension to the nickel-plated jaws.

NOTE: An additional holder must be purchased in order to attach clamps to frames or other apparatus.

See the Connectors & Holders section of this catalog, pages 195 - 197.

Min. to Max. Grip Size	Ext Arm Length	Arm Dia.	Overall Length	Item No.
6 to 12 mm (0.24 to 0.47")	127 mm (5")	11 mm (0.43")	210 mm (8.27")	30392239



Wall Clamp

Ideal for securing fermentation tubes, burets or other small objects to walls where no frames are available. Integral self-tapping screw secures clamp to wall. Nickel-plated construction.

Min. to Max. Grip Size	Overall Length	Item No.
5 to 10 mm (0.2 to 0.39")	80 mm (3.15")	30392244



Water Bath Clamps

Holds a variety of apparatus, including glass tubes and thermometers onto glass water bath walls. Built-in holder grips walls of varying thickness, up to 9 mm (0.35"). Knurled thumbscrew tightens jaws to hold objects firmly. Nickel-plated zinc construction. Large water bath clamp is supplied with non-slip vinyl sleeves and, for temperatures above 100°C, fiberglass covers.

Size	Min. to Max. Grip Size	Prong Width	Overall Length	Item No.
Small	5 to 10 mm (0.2 to 0.39")	N/A	89 mm (3.5")	30392240
Large	0 to 46 mm (0 to 1.81")	11 mm (0.43")	117 mm (4.61")	30392241



Specialty Clamps

For the items listed below an additional holder must be purchased in order to attach clamps to frames or other apparatus. See the Connectors & Holders section of this catalog, pages 195 - 197.

Chain Clamps

Holds large round or irregular shaped objects firmly, yet gently, to lab-frames and rods. Quick and secure slip-on chain connection with large, easy-to-turn adjusting knob. Extension arm allows user to vary distance from the frame. Available as stainless steel clamp, constructed entirely of stainless steel with electro-polished finish or nickel-plated zinc clamp with strong, chromed-brass chain.

Stainless Steel

Size	Min. to Max. Dia.	Ext. Arm Length	Arm Dia.	Overall Length	Item No.
Large-5	35 to 280 mm (1.38 to 11.02")	127 mm (5")	13 mm (0.51")	206 mm (8.11")	30392224



30392224
(shown in stainless steel)

Nickel-Plated Zinc

Size	Min. to Max. Dia.	Ext. Arm Length	Arm Dia.	Overall Length	Item No.
Small	35 to 170 mm (1.38 to 6.69")	127 mm (5")	13 mm (0.51")	188 mm (7.4")	30392235
Large-5	35 to 280 mm (1.38 to 11.02")	127 mm (5")	13 mm (0.51")	206 mm (8.11")	30392259
Large-12	35 to 280 mm (1.38 to 11.02")	305 mm (12")	13 mm (0.51")	384 mm (15.12")	30392260

Column Clamps

These sturdy, easily adjusted, multi-purpose clamps are ideal for holding large cylindrical glassware and similar objects. A large, flat thumbscrew/worm-drive permits maximum tightening or removal in minimum time. Clamp is constructed of corrosion-resistant stainless steel. Ideal for chromatography columns.

Size	Min. to Max. Dia.	Ext. Arm Length	Arm Dia.	Overall Length	Item No.
Small	65 to 89 mm (2.56 to 3.5")	211 mm (8.31")	11 mm (0.43")	282 mm (11.1")	30392314
Medium	91 to 114 mm (3.58 to 4.49")	211 mm (8.31")	11 mm (0.43")	315 mm (12.4")	30392315
Large	64 to 140 mm (2.52 to 5.51")	211 mm (8.31")	11 mm (0.43")	338 mm (13.31")	30392316
X-Large	92 to 165 mm (3.62 to 6.5")	211 mm (8.31")	11 mm (0.43")	368 mm (14.49")	30392317



30392316

Specialty Clamps

For the items listed below an additional holder must be purchased in order to attach clamps to frames or other apparatus. See the Connectors & Holders section of this catalog, pages 195 - 197.

Nester Extension Clamps

Securely holds large or small glass distillation columns and odd-shaped glassware. Constructed of stainless steel with strong, chromed-brass band and chain.

Min. to Max. Dia.	Ext. Arm Length	Arm Dia.	Overall Length	Item No.
50 to 102 mm (1.97 to 4")	152 mm (5.98")	10 mm (0.39")	262 mm (10.32")	30392318



30392318

PVC Coated Open Extension Rings

Ideal for supporting funnels, round bottom flasks, reaction vessels, and other apparatus that require lower support. Opening in PVC coated aluminum ring allows for easy removal of sample container. PVC coating protects glassware. Long extension arm permits depth adjustment of the open ring from the lab-frame or ring stand.

Ring Dia.	Ext. Arm Length	Arm Dia.	Overall Length	Item No.
76 mm (3")	254 mm (10")	9 mm (0.35")	328 mm (12.91")	30392346
102 mm (4")	305 mm (12")	9 mm (0.35")	404 mm (15.91")	30392347
127 mm (5")	305 mm (12")	11 mm (0.43")	427 mm (16.81")	30392348



30392347

Open Rings

Lightweight rings mount funnels, boiling flasks, and other irregular shaped objects to lab-frames. Open ring section allows items to pass in and out of support area easily, reducing risk of breakage. Aluminum construction.

Ring Dia.	Ext. Arm Length	Arm Dia.	Overall Length	Item No.
76 mm (3")	58 mm (2.28")	9 mm (0.35")	132 mm (5.2")	30392343
102 mm (4")	58 mm (2.28")	9 mm (0.35")	158 mm (6.22")	30392344
127 mm (5")	61 mm (2.4")	11 mm (0.43")	183 mm (7.2")	30392345

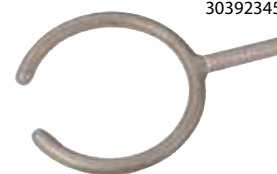

30392345

Specialty Clamps

Buret Holders

Stainless steel electro-polished finish or nickel-plated zinc construction. Double Buret Clamp holds any size buret from micro to 100 mL capacity. Simply compress the scissor-like mechanism, insert buret and gently release to grip. Numbers and graduation on buret remain easy to read. For height adjustments, recompress mechanism and slide buret up or down and gently release. Clamp unit with built-in reinforced hook connector attaches to optional standard support rod. Adjusting nut faces forward for easy use. Stainless steel or aluminum support rod attaches to optional porcelain base.

Support Rod (Dia. × L): 13 × 578 mm (0.51 × 22.76")

Porcelain Base (L × W × H): 178 × 330 × 25 mm (7 × 13 × 1")

Stainless Steel

Description	Item No.
Double Buret Clamp (only)	30392227
Support Rod (only)	30392233
Support Stand with Rod	30392232
Double Buret Clamp & Support Stand with Rod (complete)	30392231

Nickel-Plated Zinc

Description	Item No.
Double Buret Clamp (only)	30392234
Support Stand with Rod	30392312
Double Buret Clamp & Support Stand with Rod (complete)	30392313



30392231
(shown in stainless steel)

Kettle Clamps

Holds flask and cover together firmly. Three insulated spring-activated clamping arms. Stainless steel springs. For use on reaction kettles.

Flask Size	Inside Dia.	Item No.
500 mL, 1000 mL	125 mm (4.92")	30392365
2000 mL, 3000 mL, 4000 mL	142 mm (5.59")	30392366



30392365

Electrode Support Clamp

Permits suspension of electrodes over beaker for potentiometric titrations. Holds any electrode clamp at desired level. Built-in nickel-plated zinc holder grips rods up to 19 mm (0.75") in diameter.

Overall Length	Item No.
178 mm (7")	30392242



30392242
Electrode holder not included

Suspension Clamp

Holds thermometers, potash bulbs or drying tubes 114 mm (4.49") from support rod. Machine tapered, nickel-plated brass hook won't bend, rust, or corrode. Built-in holder grips rods up to 19 mm (0.75") in diameter.

Overall Length	Item No.
137 mm (5.39")	30392243



30392243

Support Clamp

Supports electrolysis apparatus, glass rods or tubing at any angle. Arms are nickel-plated brass with vinyl coating. Easily supports cylindrical objects up to 19 mm (0.75") in diameter. Built-in holder grips rods up to 19 mm (0.75") in diameter.

Overall Length	Prong Width	Item No.
152 mm (5.99")	25 mm (1")	30392237



30392237

Specialty Clamps

Ultra Flex Support Systems have unique flexible arms that are extremely versatile and can be placed in virtually any position or angle. Ultra Flex comes in three different systems; base plate, lab-frame connector, and bench clamp. Each system includes a 2-Prong Clamp Head, 3-Prong Clamp Head, Spring Clamp Head, nickel-plated flex arm in 305 mm (12") or 457 mm (18") length, and utility wrench. 2-prong and 3-prong clamp heads also supplied with non-slip vinyl sleeves and, for temperatures above 100°C, fiberglass covers.

Arm Length	Ultra Flex 12 Ultra Flex 18	305 mm (12") 457 mm (18")
Arm Diameter		13 mm (0.51")
Max. Grip Size	2-Prong Clamp Head 3-Prong Clamp Head Spring Clamp Head	75 mm (2.95") 69 mm (2.72") 13 mm (0.51")

2-Prong Clamp Head



3-Prong Clamp Head



Spring Clamp Head



Ultra Flex Support System with Base Plate

OHAUS Ultra Flex Support System with Base Plate is constructed of all metal and designed with a stable, painted steel base plate with chemical resistant black finish that fits easily on bench tops or in fume hoods. Base plate measures 127 × 127 × 12.7 mm (5 × 5 × 0.5").

Description	Item No.
Ultra Flex 12 with Base Plate	30400011
Ultra Flex 18 with Base Plate	30400014



30400014

Ultra Flex Support System with Lab-Frame Connector

Ultra Flex Support System with Lab-Frame Connector securely attaches to support stands, lab-frames, or any support rod up to 19 mm (0.75") in diameter. Ideal for use in fume hoods. Lab-frame connector is made of cast alloy.

Description	Item No.
Ultra Flex 12 with Lab-Frame Connector	30400013
Ultra Flex 18 with Lab-Frame Connector	30400016



30400013

Ultra Flex Support System with Bench Clamp

Ultra Flex Support System with Bench Clamp easily attaches to the side of your lab bench or counter top, which helps utilize more space in your lab. Bench clamp is constructed of aluminum.

Description	Item No.
Ultra Flex 12 with Bench Clamp	30400012
Ultra Flex 18 with Bench Clamp	30400015



30400015

Specialty Clamps

Bench Clamp

Aluminum bracket with arm fastens quickly and firmly to any convenient shelf. Accepts 13 mm (0.51") rods vertically and horizontally, to which ordinary rings and clamps attach, leaving bench surface clear for apparatus.

Clamp Opening	Depth of Grip	Overall Length	Item No.
1.7" (43 mm)	2" (51 mm)	7.75" (197 mm)	30392311



30392311

Thumbscrew Knob

Thumbscrew tightening knob features a 32 mm (1.25") slot in the center of a nylon disc that will accept thumbscrews supplied with the LabJaws and UltraJaws Multi-Purpose Clamps, excluding the stainless steel version. Makes tightening of clamps easier on the hands and wrists.

Overall Diameter	Thumbscrew Slot	Item No.
64 mm (2.5")	32 mm (1.25")	30392192



30392192

Double Jaw Utility Clamp

Swivels 360° and locks securely in desired position. These 2-prong clamps have a medium and a large clamp on each end. Nickel-plated zinc construction. Supplied with non-slip vinyl sleeves and, for temperatures above 100°C, fiberglass covers.



30392236

Description	Min. to Max. Grip Size	Prong Width	Overall Length	Item No.
Medium 2-Prong	0 to 76 mm (0 to 3")	23 mm (0.91")	222 mm (8.74")	30392236

Connectors & Holders

Regular Holder

Stainless steel electro-polished finish or nickel-plated zinc construction. Ideal for holding clamps to lab-frames. Use wherever clamping at 90° is required.

Material	Min. to Max. Grip Size	Item No.
Stainless steel	0 to 18 mm (0 to 0.71")	30392219
Nickel-plated zinc	0 to 18 mm (0 to 0.71")	30392197



30392219
(shown in stainless steel)

Jumbo Holder

Stainless steel electro-polished finish or aluminum construction. Ideal for holding clamps to lab-frames or ring stands.

Material	Min. to Max. Grip Size	Item No.
Stainless steel	0 to 21 mm (0 to 0.83")	30392357
Aluminum	0 to 21 mm (0 to 0.83")	30392196



30392357
(shown in stainless steel)

Heavy-Duty Holder

For mounting stirrers and other apparatus. Holder is constructed of strong aluminum alloy; fitted with oversized knobs for very secure positioning. Rods supported on 102 mm (4") long surface to avoid vibration and wobble.

Material	Min. to Max. Grip Size	Item No.
Aluminum	6 to 24 mm (0.24 to 0.95")	30400045



30400045

Swivel Holder

Two rod holders with center swivel capacity allow tilting of clamps at any angle in parallel planes. Outside adjustment screw allows close proximity between items being held. Stainless steel electro-polished or nickel-plated zinc construction.

Material	Min. to Max. Grip Size	Item No.
Stainless steel	0 to 19 mm (0 to 0.75")	30392228
Nickel-plated zinc	0 to 19 mm (0 to 0.75")	30392213



30392228
(shown in stainless steel)

All-Position Clamp Holder

Surpasses standard holding capabilities. The all-position clamp holder permits adjustment at any angle in any plane. Holders are set at 90° to each other, connected by a 90° connector, allowing 360° rotation. Nickel-plated zinc construction.

Material	Min. to Max. Grip Size	Item No.
Nickel-plated zinc	0 to 19 mm (0 to 0.75")	30392248



30392248

Clamp Holder

Clamp is ideal for gripping 2 rods at 90°. Oversized thumbscrews make securing rods fast and easy.

Material	Min. to Max. Grip Size	Overall Length	Item No.
Aluminum	0 to 17 mm (0 to 0.66")	70 mm (2.75")	30392195



30392195

Connectors & Holders

Hook Connector

Stainless steel electro-polished finish or nickel-plated zinc construction. Simple, versatile, and easy-to-use. Hook connectors allow one-handed assembly of two components with one adjustment screw.

Material	Min. to Max. Grip Size	Item No.
Stainless steel	0 to 13 mm (0 to 0.51")	30392358
Nickel-plated zinc	0 to 13 mm (0 to 0.51")	30392258



30392358
(shown in stainless steel)

End-to-End Connector

Extend the length of lab-frame rods. Strong aluminum alloy connector permits end-to-end joining of rods. Precision boring of connector ensures perfect alignment of rods. Corrosion resistant. Comes with two set screws.

Material	Min. to Max. Grip Size	Item No.
Aluminum	0 to 13 mm (0 to 0.51")	30392264



30392264

Rod End Connector

Holds rods firmly at 90°. Use when semi-permanent installations are required. Comes with two set screws and is precision bored for close fit. Stainless steel electro-polished finish or nickel-plated zinc construction.

Material	Min. to Max. Grip Size	Item No.
Stainless steel	0 to 13 mm (0 to 0.51")	30392222
Nickel-plated zinc	0 to 13 mm (0 to 0.51")	30392256

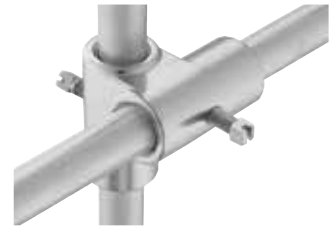

30392222
(shown in stainless steel)

S-Connector

Stainless steel electro-polished finish or nickel-plated zinc construction. Clamp is ideal for constructing lab-frames or other supports requiring the connection of two perpendicular rods. Clamp connects two 13 mm (0.51") rods at a 90° angle and features separate adjustment screws for each rod location.

Material	Min. to Max. Grip Size	Item No.
Stainless steel	0 to 13 mm (0 to 0.51")	30392355
Nickel-plated zinc	0 to 13 mm (0 to 0.51")	30392257



30392355
(shown in stainless steel)

Frame Connector (Pack of 12)

Improved contour delivers simplicity and strength. Angled adjustment screws allow easy set-up and prevents misalignment. Smooth, rounded surfaces are easy-to-clean. Small size maximizes lab-frame space. Bright dipped aluminum finish sealed with silicon for maximum protection against corrosion.

Material	Min. to Max. Grip Size	Item No.
Aluminum	0 to 13 mm (0 to 0.51")	30392255



30392255

Connectors & Holders

Universal Stirrer Mounting Bracket

Use to mount stirrers and other devices to lab-frames. Aluminum mounting bracket with attachment screws.

Max. Weight Mounted	Min. to Max. Grip Size	Item No.
2.27 kg (5 lbs)	0 to 20 mm (0 to 0.78")	30392265



30392265

Multi-Rod Connector

Maximum adjustment capability within one connector. Two adjustment rods fit into the oval hole in the connector, preventing turning when tightened. Side and front 13 mm (0.51") holes allow creation of a variety of configurations. Nickel-plated zinc construction.

Min. to Max. Rod Size	Item No.
0 to 13 mm (0 to 0.51")	30392262

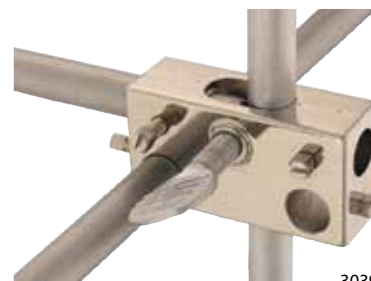

30392262

Wrench

Special adjusting wrench is for use with lab-frame items with set screws.

Length	Item No.
79 mm (3.11")	30392270



30392270

Channel Connector

Special connector fastens lab-frame rod to steel 41 mm (1.61") channels. Loosen the connector and slide up or down for easy adjustment of rod position.

Dimensions	Item No.
33 x 40 mm (1.3 x 1.58")	30392261

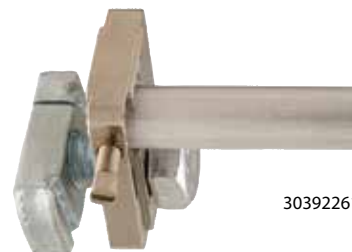

30392261

Horizontal Mounting Bars with Coupler

Threaded end for direct installation into channels. Comes with spring coupler for use in steel 41 mm (1.61") channels. Locking nut included. Use with steel channel frames.

Bar Length	Item No.
51 mm (2")	30392266
102 mm (4")	30392267
152 mm (6")	30392268
203 mm (8")	30392269



30392268

Rods, Frames, & Supports

Lab Frame Foot

Stainless steel electro-polished finish or nickel-plated zinc construction. Strong, durable lab-frame foot is designed for mounting lab-frames permanently to bench tops, fume hoods, walls, and floors. Spilled fluids roll right off the smooth body contour, minimizing contamination and easing clean-ups. Features a set screw and includes three 19 mm (0.75") mounting screws.

Material	Min. to Max. Grip Size	Dimensions (Dia. × H)	Item No.
Stainless steel	0 to 0.51" (0 to 13 mm)	2.3 × 1.25" (58 × 32 mm)	30392356
Nickel-plated zinc	0 to 0.51" (0 to 13 mm)	2.3 × 1.25" (58 × 32 mm)	30392263



30392356
(shown in stainless steel)

Frame Rods

Everything you need to customize a lab-frame to your laboratory space. Quality construction throughout. Frame rods are available in many lengths and materials.

Aluminum

Center-less ground for a precise fit. These hard aluminum rods provide a smooth fit with lab-frames. Corrosion resistant with chamfered ends for easy location.



Stainless Steel

Heavy-duty, top-of-the-line rods provide maximum strength and durability. Constructed of 303 stainless steel.

Material	Rod Diameter	Rod Length	Item No.
Stainless Steel	0.51" (13 mm)	1.61" (41 mm)	30392293
Stainless Steel	0.51" (13 mm)	2" (51 mm)	30392294
Stainless Steel	0.51" (13 mm)	6" (152 mm)	30392295
Stainless Steel	0.51" (13 mm)	12" (305 mm)	30392296
Stainless Steel	0.51" (13 mm)	18" (457 mm)	30392297
Stainless Steel	0.51" (13 mm)	24" (610 mm)	30392298
Stainless Steel	0.51" (13 mm)	36" (914 mm)	30392299
Stainless Steel	0.51" (13 mm)	48" (1219 mm)	30392300
Stainless Steel	0.51" (13 mm)	60" (1524 mm)	30392301
Stainless Steel	0.51" (13 mm)	72" (1829 mm)	30392302
Stainless Steel	0.51" (13 mm)	96" (2438 mm)	30392303
Aluminum	0.51" (13 mm)	1.61" (41 mm)	30392271
Aluminum	0.51" (13 mm)	2" (51 mm)	30392272
Aluminum	0.51" (13 mm)	6" (152 mm)	30392273
Aluminum	0.51" (13 mm)	12" (305 mm)	30392274
Aluminum	0.51" (13 mm)	18" (457 mm)	30392275
Aluminum	0.51" (13 mm)	24" (610 mm)	30392276
Aluminum	0.51" (13 mm)	36" (914 mm)	30392277
Aluminum	0.51" (13 mm)	48" (1219 mm)	30392278
Aluminum	0.51" (13 mm)	60" (1524 mm)	30392279
Aluminum	0.51" (13 mm)	72" (1829 mm)	30392280
Aluminum	0.51" (13 mm)	96" (2438 mm)	30392281

Rods, Frames, & Supports

LabJaws offers the widest choice of standard lab frames available, plus the accessories to custom-fit any laboratory with the right frame for the job. Standard Lab-Frame sets are available in five sizes. Options of traditional center-less ground aluminum, non-corroding fiberglass, or tough stainless steel rods are available. Nickel-plated zinc connectors and lab-frame feet are standard with all kits.

Small Lab-Frame

Vertical mounting, great for glassware set-ups in small laboratories or where space is limited. Frame measures 24 × 24" (610 × 610 mm). Base is 18" (457 mm) wide for stability. Base may be permanently mounted to bench top with screws (included).

Components:

- (8) 2" (51 mm) Rods
- (2) 18" (457 mm) Rods
- (8) 24" (610 mm) Rods
- (18) S-Connectors
- (4) Rod End Connectors
- (4) Lab-Frame Feet



Material	Frame Dimensions	Base Dimensions	Item No.
Stainless Steel	24 × 24" (610 × 610 mm)	18" (457 mm) wide	30392323
Aluminum	24 × 24" (610 × 610 mm)	18" (457 mm) wide	30392304

Medium Lab-Frame

Horizontal or vertical mounting, convenient for distillation or general set-up. Frame measures 24 × 48" (610 × 1219 mm). Base is 18" (457 mm) wide for stability.

Components:

- (8) 2" (51 mm) Rods
- (2) 18" (457 mm) Rods
- (7) 24" (610 mm) Rods
- (4) 48" (1219 mm) Rods
- (35) S-Connectors
- (4) Rod End Connectors
- (4) Lab-Frame Feet



Material	Frame Dimensions	Base Dimensions	Item No.
Stainless Steel	24 × 48" (610 × 1219 mm)	18" (457 mm) wide	30392324
Aluminum	24 × 48" (610 × 1219 mm)	18" (457 mm) wide	30392305

Rods, Frames, & Supports

Large Lab-Frame

This 48 × 48" (1219 × 1219 mm) frame is ideal for complex glassware set-ups. Base is 18" (457 mm) wide for stability.

Components:

- (10) 2" (51 mm) rods
- (3) 18" (457 mm) rods
- (2) 36" (914 mm) rods
- (10) 48" (1219 mm) rods
- (38) S-Connectors
- (4) Rod End Connectors
- (6) Lab-Frame Feet



Material	Frame Dimensions	Base Dimensions	Item No.
Stainless Steel	48 × 48" (1219 × 1219 mm)	18" (457 mm) wide	30392325
Aluminum	48 × 48" (1219 × 1219 mm)	18" (457 mm) wide	30392306

Extra-Large Lab-Frame

Versatile, adaptable Extra-Large Lab-Frame measures 48 × 72" (1219 × 1829 mm) and may be used either horizontally or vertically.

Components:

- (6) 2" (51 mm) rods
- (6) 12" (305 mm) rods
- (2) 24" (610 mm) rods
- (7) 48" (1219 mm) rods
- (5) 72" (1829 mm) rods
- (45) S-Connectors
- (4) Rod End Connectors
- (8) Lab-Frame Feet



Material	Frame Dimensions	Stainless Steel Item No.
Stainless Steel	48 × 72" (1219 × 1829 mm)	30392326
Aluminum	48 × 72" (1219 × 1829 mm)	30392307

Rods, Frames, & Supports

Heavy-Duty Lab-Frame

Floor mounted, free-standing unit is specifically designed for heavy-duty work such as pilot plant set-ups. Outside frame is constructed of a strong, but lightweight steel channel. Interior lattice uses a horizontal channel connector; one end accommodates the rod, the other end fits into the channel and locks tightly with a bolt. Loosen the bolt, and the connector slides easily along the channel track for simple lattice adjustment. Entire apparatus is supported on sturdy, counter-weighted cast iron feet, which may be bolted to the floor for added stability required in top-heavy installations.



Components:

- (5) 48" (1219 mm) rods
- (3) 72" (1829 mm) rods
- (15) S-Connectors
- (16) Channel Connectors
- (24) Clamping Nuts
- (2) 21.7" (551 mm) Cast Iron Feet
- (1) Frame Kit
- (1) Wrench

Material	Frame Dimensions	Overall Dimensions	Item No.
Stainless Steel	48 × 72" (1219 × 1829 mm)	75 × 72" (1905 × 1829 mm)	30392328
Aluminum	48 × 72" (1219 × 1829 mm)	75 × 72" (1905 × 1829 mm)	30392309

Fume Hood Kits

Choose from four kits specifically designed to fit within laboratory fume hoods. All components are constructed of stainless steel with the exception of the Frame Connectors which are made of aluminum with a silicon finish.

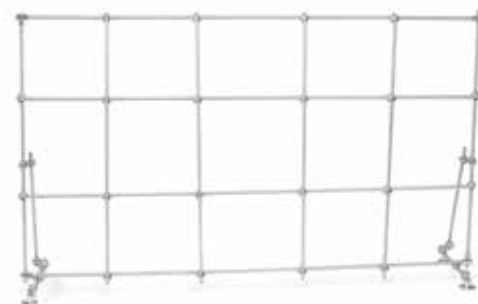

4' (1.22 m) Fume Hood Kit		5' (1.52 m) Fume Hood Kit		6' (1.83 m) Fume Hood Kit		8' (2.44 m) Fume Hood Kit	
Components: <ul style="list-style-type: none"> • (8) 2" (51 mm) rods • (2) 12" (305 mm) rods • (2) 18" (457 mm) rods • (4) 36" (914 mm) rods • (4) 38" (965 mm) rods • (30) Frame Connectors • (4) Rod End Connectors • (4) Lab-Frame Feet Frame: 36 × 38" (914 × 965 mm) Base: 12" (305 mm) wide		Components: <ul style="list-style-type: none"> • (8) 2" (51 mm) rods • (2) 12" (305 mm) rods • (2) 18" (457 mm) rods • (5) 36" (914 mm) rods • (4) 50" (1270 mm) rods • (34) Frame Connectors • (4) Rod End Connectors • (4) Lab-Frame Feet Frame: 36 × 50" (914 × 1270 mm) Base: 12" (305 mm) wide		Components: <ul style="list-style-type: none"> • (8) 2" (51 mm) rods • (2) 12" (305 mm) rods • (2) 18" (457 mm) rods • (6) 36" (914 mm) rods • (4) 62" (1575 mm) rods • (38) Frame Connectors • (4) Rod End Connectors • (4) Lab-Frame Feet Frame: 36 × 62" (914 × 1575 mm) Base: 12" (305 mm) wide		Components: <ul style="list-style-type: none"> • (10) 2" (51 mm) rods • (3) 12" (305 mm) rods • (2) 18" (457 mm) rods • (8) 36" (914 mm) rods • (4) 86" (2184 mm) rods • (45) Frame Connectors • (4) Rod End Connectors • (6) Lab-Frame Feet Frame: 36 × 86" (914 × 2184 mm) Base: 12" (305 mm) wide	
Item No.	30392329	Item No.	30392330	Item No.	30392331	Item No.	30392332

Rods, Frames, & Supports

Support Stands

Support Stands are made entirely of 303 stainless steel. They have a durable base that can accommodate vessels up to 18" (457 mm) in diameter within the "U". The base area is 17.75" (451 mm) across x 10.5" (267 mm) deep overall. The stainless steel support rod is 0.63" (16 mm) in diameter and is screwed to the support base. Two additional threaded holes in the base legs accommodate rods, enabling the stand to support two mixers. The "U" shape of the base should be turned from the mixing apparatus when the two outside rods are in use. This balances the weight, preventing the base from tipping.

Description	Item No.
Support Stand with 23" (584 mm) Rod	30400030
Support Stand with 28" (711 mm) Rod	30400031
Support Stand with 36" (914 mm) Rod	30400032
Support Stand with 40" (1016 mm) Rod	30400033
Support Stand with 48" (1219 mm) Rod	30400034
Support Stand with 60" (1524 mm) Rod	30400035



Support Stand

Support Stand Stabilizer Knobs

Support Stand Stabilizer Knobs can be added to the two additional threaded holes in the base legs to secure the stand to a bench top.

Description	Item No.
Support Stand Stabilizer Knobs (2 per pack)	30400044



Support Stand Stabilizer Knobs

Heavy-Duty Support Stands

Heavy-Duty Support Stands have a four point cast iron base with stainless steel support rod. They are designed to accommodate vessels up to 12" (30.5 cm) in diameter to sit close to the support rod. They have rubber cushions on each of the four corners. The base area is 16.5" (41.9 cm) across x 12" (30.5 cm) deep overall. They are ideal for Heavy-Duty Mixers, page 167-168.

Description	Item No.
Heavy-Duty Support Stand with 18" (457 mm) Rod	30392334
Heavy-Duty Support Stand with 23" (584 mm) Rod	30392335
Heavy-Duty Support Stand with 28" (711 mm) Rod	30392336
Heavy-Duty Support Stand with 36" (914 mm) Rod	30392337
Heavy-Duty Support Stand with 40" (1016 mm) Rod	30392338
Heavy-Duty Support Stand with 48" (1219 mm) Rod	30392339
Heavy-Duty Support Stand with 60" (1524 mm) Rod	30392340



Heavy-Duty Support Stand

Replacement Support Rods

Description	Diameter	Item No.
18" (457 mm) Stainless Steel Rod	0.63" (16 mm)	30400036
23" (584 mm) Stainless Steel Rod	0.63" (16 mm)	30400037
28" (711 mm) Stainless Steel Rod	0.63" (16 mm)	30400038
36" (914 mm) Stainless Steel Rod	0.63" (16 mm)	30400039
40" (1016 mm) Stainless Steel Rod	0.63" (16 mm)	30400040
48" (1219 mm) Stainless Steel Rod	0.63" (16 mm)	30400041
60" (1524 mm) Stainless Steel Rod	0.63" (16 mm)	30400042



Replacement Support Rods

Rods, Frames, & Supports

Cast Iron Support Stands

Cast iron support stand bases are constructed with black enamel finish for chemical resistance and durability. All bases feature a built-in support rod holder with locking knob that accepts a 0.51" (13 mm) diameter support rod. U-shaped base features three built-in support rod holders and accommodates vessels up to 5" (127 mm) in diameter.

NOTE: Support rods are not included.



Rectangular Base Support Stand, Cast Iron

Description	Dimensions	Item No.
Rectangular Base (only)	4 × 6" (102 × 152 mm)	30392359
Rectangular Base (only)	5 × 8" (127 × 203 mm)	30392360
Rectangular Base (only)	6 × 9" (152 × 229 mm)	30392361
Rectangular Base (only)	8 × 10" (203 × 254 mm)	30392362

Tripod Base Support Stand, Cast Iron

Description	Overall Footprint Diameter	Item No.
Tripod Base (only)	14.75" (375 mm)	30392363



U-Shaped Base Support Stand, Cast Iron

Description	Dimensions	Item No.
U-Shaped Base (only)	7 × 7" (178 × 178 mm)	30392364

Aluminum Support Rods

Description	Diameter	Item No.
12" (305 mm) Aluminum Rod	0.51" (13 mm)	30392274
18" (457 mm) Aluminum Rod	0.51" (13 mm)	30392275
24" (610 mm) Aluminum Rod	0.51" (13 mm)	30392276
36" (914 mm) Aluminum Rod	0.51" (13 mm)	30392277



Stainless Steel Support Rods

Description	Diameter	Item No.
12" (305 mm) Stainless Steel Rod	0.51" (13 mm)	30392296
18" (457 mm) Stainless Steel Rod	0.51" (13 mm)	30392297
24" (610 mm) Stainless Steel Rod	0.51" (13 mm)	30392298
36" (914 mm) Stainless Steel Rod	0.51" (13 mm)	30392299



Rods, Frames, & Supports

Round Support Plate

Aluminum plate supports beakers, mantles and petri dishes. Fits standard lab-frames using connectors or holders, shown on pages 195-197.

Description	Distance from Rod	Item No.
6" (152 mm)	2.6" (66 mm)	30392342



Support Plates

Designed to hold hotplates, stirrers, hotplate-stirrers, and other apparatus to lab-frames or ring stands. Aluminum construction offers strength and durability. Support plates include a non-skid rubber mat and a built-in holder that grips rods up to 0.75" (19 mm) in diameter.

Size	Plate Dimensions	Distance from Rod	Item No.
Small	9.5 × 6.5" (241 × 165 mm)	1.9" (48 mm)	30392349
Medium	12.75 × 9" (324 × 229 mm)	1.9" (48 mm)	30392350
Large	15.75 × 12" (400 × 305 mm)	1.9" (48 mm)	30392351



Rods, Frames, & Supports

OHAUS Aluminum Lab-Lifts

- Exceptional stability and durability
- Aluminum construction
- Three convenient sizes

Aluminum Lab-Lifts provide stable height adjustment for various items in the lab such as flasks, baths, and small equipment. Top and bottom decks are constructed of anodized aluminum. Internal supports and drive screws are constructed of stainless steel. Oversized sure-grip adjustment knobs provide smooth and accurate height adjustment. Lab-Lifts accept optional Support Rod Kit which mounts to the upper deck.



Deck Size	Min. to Max. Height	Max. Load*	Item No.
4 × 4" (102 × 102 mm)	2.5 to 5" (64 to 127 mm)	66 lbs (29.94 kg)	30400007
6 × 6" (152 × 152 mm)	3 to 9.75" (76 to 248 mm)	132 lbs (59.87 kg)	30400008
8 × 8" (203 × 203 mm)	3 to 9.75" (76 to 248 mm)	176 lbs (79.83 kg)	30400009
10 × 10" (254 × 254 mm)	3.5 to 13" (89 to 330 mm)	186 lbs (84.37 kg)	30400010

*NOTE: Maximum load rating represents static weight only. Static weight is the amount a unit can hold, not lift.

OPTIONAL ACCESSORIES

17" Support Rod Kit

Ideal for creating an adjustable support stand for mounting various items such as thermometer clamps, temperature probes, flask and column clamps. This kit allows you to mount a 17" (432 mm) threaded vertical support rod to the upper deck of a 6 × 6", 8 × 8", 10 × 10", 12 × 12" or 16 × 16" Lab-Lift by screwing the rod into the pre-drilled hole.

17" Support Rod Kit includes:

- 1 - 17" (432 mm) Stainless Steel Rod
- 1 - Jam Nut
- 1 - Flat Washer



Description	Rod Diameter	Item No.
17" Support Rod Kit	0.51" (13 mm)	30400050

Rods, Frames, & Supports

OHAUS Heavy-Duty Lab-Lifts

- Stainless steel construction
- Seven convenient sizes to choose from
- Autoclavable and chemical resistant

These Heavy-Duty, Stainless Steel Lab-Lifts are ultra-stable lifting platforms with exceptional strength and durability. Constructed of stainless steel, Lab-Lifts are designed for use in extreme environments and high load applications. Equipped with oversized, sure-grip adjustment knobs that provide extra leverage for easy height adjustments. Durable construction allows lifts to be autoclaved or chemically cleaned. Ideal for use in fume hoods or bench tops and holds a variety of items such as glassware, hotplates, baths, and magnetic stirrers.



Deck Size	Min. to Max. Height	Max. Load*	Item No.
3 × 3" (76 × 76 mm)	2.5 to 5" (64 to 127 mm)	100 lbs (45.36 kg)	30400000
4 × 4" (102 × 102 mm)	2.5 to 5" (64 to 127 mm)	100 lbs (45.36 kg)	30400001
6 × 6" (152 × 152 mm)	3 to 9.75" (76 to 248 mm)	133 lbs (60.33 kg)	30400002
8 × 8" (203 × 203 mm)	3 to 9.75" (76 to 248 mm)	227 lbs (102.97 kg)	30400003
10 × 10" (254 × 254 mm)	3.5 to 13" (89 to 330 mm)	247 lbs (112.04 kg)	30400004
12 × 12" (305 × 305 mm)	4 to 19.5" (102 to 495 mm)	100 lbs (45.36 kg)	30400005
16 × 16" (406 × 406 mm)	4 to 19.5" (102 to 495 mm)	100 lbs (45.36 kg)	30400006

*NOTE: Maximum load rating represents static weight only. Static weight is the amount a unit can hold, not lift.

OPTIONAL ACCESSORIES

17" Support Rod Kit

Ideal for creating an adjustable support stand for mounting various items such as thermometer clamps, temperature probes, flask and column clamps. This kit allows you to mount a 17" (432 mm) threaded vertical support rod to the upper deck of a 6 × 6", 8 × 8", 10 × 10", 12 × 12" or 16 × 16" Lab-Lift by screwing the rod into the pre-drilled hole.

17" Support Rod Kit includes:

- 1 - 17" (432 mm) Stainless Steel Rod
- 1 - Jam Nut
- 1 - Flat Washer



Description	Rod Diameter	Item No.
17" Support Rod Kit	0.51" (13 mm)	30400050

Ratchet Tool

Designed to add extra leverage to your 12 × 12" or 16 × 16" Lab-Lift. This recommended Ratchet Tool easily attaches to the actuating rod to allow easy, accurate adjustments.

Description	Item No.
Ratchet Tool	30400049



Rods, Frames, & Supports

Cylinder Bench Clamps

Rugged cast aluminum clamps safely secure gas cylinders to benches, tables or other flat surfaces up to 2.5" (64 mm) thick. The 1" (25 mm) wide, 54" (1372 mm) long nylon strap features a nickel-plated, non-slip spring catch and buckle for easy adjustment around cylinders from 4 to 14" (102 to 356 mm) in diameter. Models 711 and 716 available with or without a "Secure Cylinder" safety message strap.

Model 711 Bench Clamp

This bench clamp has a large tightening handle for mounting to any flat surface up to 2.5" (64 mm) thick. A nylon pad prevents damage to the bench or table surface. Two tapered mounting screw holes are provided for permanent attachment to bench-top.



safety message strap

Description	Dimensions L x W x H (closed)	Cylinder Diameter	Item No.
Model 711 Bench Clamp with Strap	3.25 x 5.25 x 6.5" (83 x 133 x 165 mm)	4 to 14" (102 to 356 mm)	30400020
Model 711 Bench Clamp with Safety Message Strap	3.25 x 5.25 x 6.5" (83 x 133 x 165 mm)	4 to 14" (102 to 356 mm)	30400021

Model 716 Bench Clamp

This bench clamp is similar to Model 711, but includes a sturdy safety chain for extra security. Chain measures 49" (1245 mm).



safety message strap

Description	Dimensions L x W x H (closed)	Cylinder Diameter	Item No.
Model 716 Bench Clamp with Strap & Chain	3.25 x 5.25 x 6.5" (83 x 133 x 165 mm)	4 to 14" (102 to 356 mm)	30400026
Model 716 Bench Clamp with Safety Message Strap & Chain	3.25 x 5.25 x 6.5" (83 x 133 x 165 mm)	4 to 14" (102 to 356 mm)	30400027

Model 712 Heavy-Duty Bench Clamp

This bench clamp has two screw clamps to tighten for extra firm mounting to any flat surface up to 1.75" (45 mm) thick with a 1.25" (32 mm) overhang. Especially convenient for temporary storage situations. Rugged cast aluminum bench clamp features a 1" (25 mm) wide, 54" (1372 mm) long nylon strap with nickel-plated, non-slip spring catch buckle to hold cylinders from 4 to 14" (102 to 356 mm) in diameter. This clamp is not available with a safety message strap.



Description	Dimensions L x W x H (closed)	Cylinder Diameter	Item No.
Model 712 Heavy-Duty Bench Clamp with Strap	3.25 x 6 x 4.5" (83 x 152 x 114 mm)	4 to 14" (102 to 356 mm)	30400022

Rods, Frames, & Supports

Model 715 Wall Bracket

Cylinder wall-mount brackets are constructed of cast aluminum and contoured to allow cylinders to fit firmly along the support edge. Recessed screw holes at each side of the bracket allow for easy wall mounting. Features a 1" (25 mm) wide, 54" (1372 mm) long nylon strap with nickel-plated, non-slip spring catch and buckle for fast, easy adjustment. Available with or without a "Secure Cylinder" safety message strap. For cylinders from 4 to 14" (102 to 356 mm) in diameter.



safety message strap

Description	Dimensions L x W x H	Cylinder Diameter	Item No.
Model 715 Wall Bracket with Strap	1.88 x 8.13 x 4.63" (48 x 206 x 118 mm)	4 to 14" (102 to 356 mm)	30400024
Model 715 Wall Bracket with Safety Message Strap	1.88 x 8.13 x 4.63" (48 x 206 x 118 mm)	4 to 14" (102 to 356 mm)	30400025

Model 717 Wall Bracket

This wall bracket is similar to Model 715, but includes a sturdy safety chain for extra security. Chain measures 49" (1245 mm).



safety message strap

Description	Dimensions L x W x H	Cylinder Diameter	Item No.
Model 717 Wall Bracket with Strap & Chain	1.88 x 8.13 x 4.63" (48 x 206 x 118 mm)	4 to 14" (102 to 356 mm)	30400028
Model 717 Wall Bracket with Safety Message Strap & Chain	1.88 x 8.13 x 4.63" (48 x 206 x 118 mm)	4 to 14" (102 to 356 mm)	30400029

Rods, Frames, & Supports

Model 701 PVC Coated Stand

The PVC coated stand has a flat bottom support so it can't "ride up" on the cylinder. Includes an adjustable 1" (25 mm) wide, 54" (1372 mm) long nylon strap with nickel-plated, non-slip spring catch and buckle for fast, easy adjustment to keep the cylinder safely in place against upper support bar. Lower support bar stops cylinder shift. The PVC coating prevents marring of the cylinder surface. This clamp is not available with a safety message strap.



Description	Dimensions L x W x H	Cylinder Diameter	Item No.
Model 701 PVC Coated Stand	17.25 x 17.25 x 10.75" (438 x 438 x 273 mm)	7 to 10" (178 x 254 mm)	30400017

Model 703 Stand

This cast aluminum stand hinges open and has 4 thumbscrews to tightly grip cylinders from 8 to 9" (203 to 229 mm) in diameter.



Description	Dimensions (Dia. x H)	Cylinder Diameter	Item No.
Model 703 Stand	18.25 x 6" (464 x 152 mm)	8 to 9" (203 x 229 mm)	30400018

Model 704 Adjustable Stand

Heavy-duty, cast aluminum stand with adjustable "L" brackets hold cylinders from 6 to 9.25" (152 to 235 mm) in diameter. Hinges open for installation without lifting the cylinder or disturbing connections. Prevents accidental tipping. Hinges open for easy, no-lifting installation.



Description	Dimensions (Dia. x H)	Cylinder Diameter	Item No.
Model 704 Adjustable Stand	18.5 x 7.5" (470 x 191 mm)	6 to 9.25" (152 x 235 mm)	30400019

Model 713 Portable Stand

This cast iron portable cylinder stand offers a sturdy cylinder stand and a convenient cylinder dolly all-in-one. This cylinder stand is designed in two interlocking halves and can be installed without lifting the tank. Built-in rubber wheels for easy mobility. Three thumbscrews tightly grip cylinder.



Description	Dimensions (Dia. x H)	Cylinder Diameter	Item No.
Model 713 Portable Stand	15.5 x 3" (394 x 76 mm)	7 to 9.25" (178 x 235 mm)	30400023

Flow Control Clamps

LabJaws flow control devices offer selection and quality. They are finely machined to deliver accurate regulation or interruption of fluid flow. Every flow control device resists corrosion and rust. Hosecocks offer easy one-hand operation. Convex bearing surfaces and rounded edges protect tubing. Pinchcocks are designed to quickly start and stop flow and provide complete closure without damaging tubing. Operated with a simple squeeze. Nickel-plated construction (unless otherwise noted).

Regular Hosecock

Adjustment screw with oversized head for accurate regulation. Built-in side lugs for foot mounting. Tubing retainer screw.

Stainless Steel

Min. to Max. Grip	Dimensions (W × H - open)	Item No.
0 to 17 mm (0 to 0.67")	37 × 62 mm (1.46 × 2.44")	30392221

Nickel-Plated Zinc

Min. to Max. Grip	Dimensions (W × H - open)	Item No.
0 to 17 mm (0 to 0.67")	37 × 62 mm (1.46 × 2.44")	30392210

Heavy-Duty Hosecock

Large hand wheel for ease of flow adjustment. Unique design offers unparalleled control. Works well with heavy cut nylon braided tubing.

Min. to Max. Grip	Dimensions (W × H - open)	Item No.
0 to 29 mm (0 to 1.14")	57 × 106 mm (2.24 × 4.17")	30392310

Hosecock Extension Clamp

Similar to regular hosecock but with 145 mm (5.7") bottom mounted extension rod for attachment to frames and rods.

Min. to Max. Grip	Arm Length	Arm Dia.	Overall Length	Item No.
0 to 17 mm (0 to 0.67")	145 mm (5.71")	8 mm (0.32")	175 mm (6.89")	30392212

Hosecock Foot

Add this option to Regular Hosecock (916062 or 916361) for bench or table mounting. Includes two mounting screws.

Diameter	Item No.
27 mm (1.06")	30392211

Regular Pinchcock

For routine stop/start flow operation.

Min. to Max. Grip	Clamp Height	Item No.
0 to 12 mm (0 to 0.47")	47 mm (1.85")	30392245

Variable Flow Pinchcock

For precise flow adjustment and duplication of flow rates.

Min. to Max. Grip	Clamp Height	Item No.
0 to 13 mm (0 to 0.51")	47 mm (1.85")	30392247

Heavy-Duty Pinchcock

Equipped with heavy-duty spring for tough jobs. Ensures complete closure.

Min. to Max. Grip	Clamp Height	Item No.
0 to 11 mm (0 to 0.43")	48 mm (1.89")	30392246

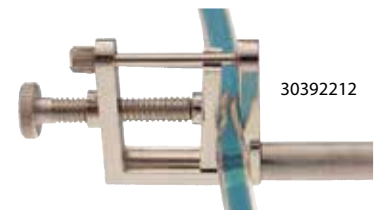

Misc. Non-Electrical Products

Inoculating Turntables

OHAUS hand-operated inoculating turntables produce almost concentric circles of bacterial colonies that are evenly distributed across petri dishes. Cast iron turntables are coated with gray baked acrylic enamel.

The 76 mm (3") high, small turntable accommodates 100 mm petri dishes. It has a tripod base to bring work approximately to eye level. It has a center disk covered with non-skid rubber lining.

The large turntable accommodates 100 mm or 150 mm petri dishes. It has a height of only 32 mm (1.26"), ideal for steadying a forearm on the work surface while plating. The large turntable contains two circular sections. The top section has a raised gripper lip as well as a recessed center disk covered with non-skid rubber lining.



30400046



30400047

Description	Dimensions (Dia. × H)	Item No.
Small Turntable	4.49 × 3.03" (114 × 77 mm)	30400046
Large Turntable	5.91 × 1.26" (150 × 32 mm)	30400047

Slide Staining Rack

Constructed of stainless steel, the OHAUS Slide Staining Rack will resist corrosion under normal use. Adjustable to fit trays or sinks up to 533 mm (21") inside.



30400048

Description	Dimensions (L × W)	Item No.
Slide Staining Rack	23.74 × 3.5" (603 × 89 mm)	30400048

Airejector

Rapid air removal evacuates 1 liter of air to 711 mm (28") of vacuum in 30 seconds. Works with compressed air sources to 60 psi. Nickel-plated construction.



30392367

Description	Length	Item No.
Airejector	5.51" (140 mm)	30392367

Laboratory Instruments



Streamline your water quality analysis applications using the intuitive OHAUS Starter Series line of bench, portable, and pen meters. With the ability to handle applications from pH to Dissolved Oxygen- and everything in between- the Starter Series boasts powerful performance that goes where you go.



Instrument Selector Guide

	Starter Series Bench Meters					Starter Series Portable Meters				Starter Series Pen Meters						
	Starter 5000	Starter 3100M	Starter 3100	Starter 3100C	Starter 2100	Starter 300	Starter 300C	Starter 300D	Starter ST400D	pH meters	ORP meters	Conductivity meters	DO meters	Salinity meters	TDS meters	Multi meters
Measurement Range	-2.000 to 20.000 pH -30°C to 130 °C	-2.00 to 20.00 pH 0.0 µS/cm to 199.9mS/cm -5°C to 110 °C	-2.00 to 16.00 pH -5 °C to 110 °C	00.0 µS/cm to 199.9 mS/cm 0 °C to 100 °C	-2.00 to 16.00 pH 0 °C to 100 °C	0.00 to 14.00 pH 0 °C to 100 °C	0.0 µS/cm to 199.9 mS/cm 0 °C to 100 °C	0.0 to 199.9%; 200 to 400% 0 °C to 50 °C	0.0 to 200.0% 0 °C to 50 °C	0.00 to 14.00 pH*	-1000mV to 1000mV	0.0 to 199.9 µS/cm*	0.0 to 19.9 mg/L	0.0 to 80.0 ppt*	0 to 1000 mg/L*	0.00 to 14.00 pH; 0-1999 µS/cm; 0-19.99 mS/cm; 0-1000 mg/L; 0.0-10.0 ppt
Input	BNC	BNC Mini-Din	BNC	Mini-Din	BNC	BNC	Mini-Din	BNC	Mini-DIN							
Automatic Temperature Compensation	•	•	•	•	•	•	•	•	•	•*	•*	•*	•*	•*	•*	•
Manual Temperature Compensation	•	•	•		•	•		•								
Battery Power						•	•	•	•	•	•	•	•	•	•	•
1 Point Calibration	•	•	•	•	•	•	•	•	•	•*	•*	•*	•*	•*	•*	•
2 Point Calibration	•	•	•		•	•		•	•	•*						
≥3 Point Calibration	•	•	•			•				•*						•
Memory	•	•	•	•		•	•	•	•							
Backlit LCD	•	•	•	•					•							
LCD					•	•	•	•		•	•	•	•	•	•	•
Touchscreen	•															
Mechanical Keys		•	•	•	•	•	•	•		•	•	•	•	•	•	•
USB	•	•														
RS232	•	•	•	•												
USB Host	•									•						
GLP / Time / Date	•					•										
Multi Languages	•															
IP Protection	X-IP54					X-IP54	X-IP54	X-IP54	X-IP54	X-IP67	X-IP67	X-IP67	X-IP67	X-IP67	X-IP67	X-IP67
Stand-alone Electrode Holder	•	•	•	•												
Quick Reference Operation Guide	•	•	•	•	•											
In-Use Cover	•	•	•	•		•	•									
Hold Function				•	•	•	•	•	•	•*	•	•	•	•	•	•
Auto Shut Off										•	•	•	•	•	•	•
Page No.	214	215	216	217	218	219	220	221	222	223	223	223	223	223	223	223

*on specific models

Starter 5000 pH Bench

High Performance Bench Meter for Universal pH Applications

- Starter 5000's performance is propelled by a 1000 item library, 10 sensors for calibration storage, 8 predefined and 1 self-defined buffer groups, 3 endpoint modes and meets GLP/GLM requirements.
- The color touchscreen operates similar to smartphones and tablets, and provides simple operation of advanced features such as one-touch toggling of measurement modes.
- With a standalone electrode holder, USB port, IP54 housing and in-use-cover, Starter 5000 provides the flexibility and protection that ensures smooth and enduring operation.



- Application** pH, oxidation-reduction potential (ORP) measurement
- Display** Backlit liquid crystal display (LCD), touchscreen
- Operation** AC adapter (included)
- Communication** RS232 and USB (included). GLP/GMP data output with real-time clock.
- Construction** ABS housing, standalone electrode holder, replaceable in-use cover
- Design Features** 3 endpoint modes, continuous measurement mode, up to 9 point calibration, 1,000 measurement memory



Model	Included Electrode	Measurement Range	Measurement Resolution	Item No.
ST5000-B	N/A	-2.00 to 20.00 pH; -2000.00 to +2000.00 ; mV-30 to 130°C	0.001 pH; 0.01 mV; 0.1 °C	30129895
ST5000-F	ST350			30129896

Accessories	Item No.
Holder, Stand Alone, Electrode	30058733
Adapter, 9 Pin-9 Pin, PC-SF40A	30059316
Printer, Impact, SF40A, AM	30064203
pH electrolyte	30059255
pH electrode protection	30059256
In-Use Cover, ST5000	30129897

Accessories	Item No.
Holder, Stand Alone, Electrode	30058733
Adapter, 9 Pin-9 Pin, PC-SF40A	30059316
Printer, Impact, SF40A, AM	30064203
Buffer pH1.68 250 ml	30100424
Buffer pH4.01 250 ml	30100425
Buffer pH6.86 250 ml	30100426
Buffer pH7.00 250 ml	30100427
Buffer pH9.18 250 ml	30100428
Buffer pH10.01 250 ml	30100429
Buffer pH12.45 250 ml	30100440
Buffer Powder pH4.01;7.00;10.01	83033971

See page 224 for additional Starter Series Electrodes



Starter 3100M Bench

The Versatile Multi-Parameter Bench Meter

- Auto temperature compensation, auto buffer recognition, six pH buffer groups, five conductivity standards and automatic/manual endpoints ensure accurate and stable measurement.
- An adjustable electrode holder, a large backlit LCD for optimal viewing of results, and a Quick Guide with set-up and navigation info combine to make ST3100M a truly user-friendly experience.
- Documenting data is made efficient with a 99-item memory for pH and conductivity measurements. RS232 interface allows you to connect to an external device such as a printer to store or transfer data.



- Application** pH & Conductivity
- Display** Backlit liquid crystal display (LCD)
- Operation** AC adapter (included)
- Communication** RS232 Interface Kit (Included)
- Construction** ABS housing, standalone electrode holder, disposable in-use cover
- Design Features** Auto Temperature Compensation, manual and auto end points, 99-item memory for pH and conductivity measurements.

Model	Included Electrode	Measurement Range	Measurement Resolution	Item No.
ST3100M-B	N/A	-2 - 20 pH; -1999 - 1999 mV; 0.0 μ S/cm - 19.99 mS/cm; 0.1 mg/l - 199.9 g/l; 0 - 20M Ω ·cm; 0 - 100 psu	0.01 pH; 1 mV; 0.01 μ S/cm; 0.01 mg/L; .01 Ω ·cm; 0.01 psu	30276082
ST3100M-F	ST310, STCON3			30276083
ST3100M-N	ST230, STTEMP30, STCON3			30332140

Accessories	Item No.
Holder, Stand Alone, Electrode	30058733
Printer, Impact, SF40A, AM	30064203
RS232 Kit, STX SPX ST3100M	30268982
USB Kit, Device, STX SPX ST3100M	30268984
pH electrolyte	30059255
pH electrode protection	30059256
In-Use-Cover, STARTER	30058734

Accessories	Item No.
Buffer pH4.01 250 ml	30100425
Buffer pH6.86 250 ml	30100426
Buffer pH7.00 250 ml	30100427
Buffer pH9.18 250 ml	30100428
Buffer pH10.01 250 ml	30100429
Buffer pH12.45 250 ml	30100440
Buffer pH1.68 250 ml	30100424
Buffer Powder pH4.01;7.00;10.01	83033971
Standard Conduct 10 μ S/cm 250 ml	30100441
Standard Conduct 84 μ S/cm 250 ml	30100442
Standard Conduct 1413 μ S/cm 250 ml	30100443
Standard Conduct 12.88mS/cm 250 ml	30100444

See page 224 for additional Starter Series Electrodes

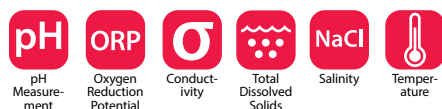

Starter 3100 pH Bench

Smart pH Bench Meter for Standard Laboratory Applications

- Starter 3100's intuitive software includes three point calibration, three buffer groups, automatic and manual endpoint functions, as well as a 99 item library.
- Among Starter 3100's user-friendly features that support ease-of-use are an adjustable standalone electrode holder and large backlit LCD display.
- Documenting measurement data is made simple through the RS232 which can be used to connect peripheral devices such as printers or computers to the meter.



- Application** pH, oxidation-reduction potential (ORP) measurement
- Display** Backlit liquid crystal display (LCD)
- Operation** AC adapter (included)
- Communication** RS232 (included)
- Construction** ABS housing, standalone electrode holder, replaceable in-use cover
- Design Features** 99 measurement memory, automatic and manual endpoint functions, automatic and manual temperature compensation, quick reference guide



Model	Included Electrode	Measurement Range	Measurement Resolution	Item No.
ST3100-B	N/A	-2.00 to 16.00 pH ; -1999 to 1999 mV; -5 °C to 110 °C	0.01 pH; 0.1 °C; 1 mV	30057497
ST3100-F	ST310			30058489

Accessories	Item No.
Holder, Stand Alone, Electrode	30058733
Adapter, 9 Pin-9 Pin, PC-SF40A	30059316
Printer, Impact, SF40A, AM	30064203
pH electrolyte	30059255
pH electrode protection	30059256
In-Use-Cover, STARTER	30058734

Accessories	Item No.
Buffer pH1.68 250 ml	30100424
Buffer pH4.01 250 ml	30100425
Buffer pH6.86 250 ml	30100426
Buffer pH7.00 250 ml	30100427
Buffer pH9.18 250 ml	30100428
Buffer pH10.01 250 ml	30100429
Buffer pH12.45 250 ml	30100440
Buffer Powder pH4.01;7.00;10.01	83033971

See page 224 for additional Starter Series Electrodes



Starter 3100C Conductivity Bench

Smart Conductivity Bench Meter for Standard Laboratory Applications

- Starter 3100C's intuitive software includes four calibration points, automatic and manual endpoint functions, and one touch conversion between measurement modes.
- Among Starter 3100C's user-friendly features that support ease-of-use are an adjustable standalone electrode holder and large backlit LCD display.
- Documenting measurement data is made simple through the RS232 which can be used to connect peripheral devices such as printers or computers to the meter.



- Application** Conductivity, total dissolved solids (TDS), salinity measurement
- Display** Backlit liquid crystal display (LCD)
- Operation** AC adapter (included)
- Communication** RS232 (included)
- Construction** ABS housing, standalone electrode holder, replaceable in-use cover
- Design Features** 99 measurement memory, automatic and manual endpoint functions, automatic and manual temperature compensation

Model	Included Electrode	Measurement Range	Measurement Resolution	Item No.
ST3100C-B	N/A	00.0 $\mu\text{S}/\text{cm}$ to 199.9 mS/cm ; 0.0 to 19.9 mg/L ; 0.00 to 19.99	0.01 $\mu\text{S}/\text{cm}$; 0.1 mg/L ; 0.01 psu ; 0.1 $^{\circ}\text{C}$	30058730
ST3100C-F	STCON3	psu (Salinity) ; 0 to 100 $^{\circ}\text{C}$		30058731

Accessories	Item No.
Holder, Stand Alone, Electrode	30058733
In-Use-Cover, STARTER	30058734
Printer, Impact, SF40A, AM	30064203
Standard Conduct 10 $\mu\text{S}/\text{cm}$ 250 ml	30100441
Standard Conduct 84 $\mu\text{S}/\text{cm}$ 250 ml	30100442
Standard Conduct 1413 $\mu\text{S}/\text{cm}$ 250 ml	30100443
Standard Conduct 12.88 mS/cm 250 ml	30100444

See page 224 for additional Starter Series Electrodes



Starter 2100 pH Bench

Economical pH Bench Meter for Basic Laboratory Applications

- With the attached quick guide, five clearly marked keys and user friendly software, novices can operate the meter with minimal training.
- The built-in electrode holder provides uncomplicated and convenient all-in-one operation while the large LCD display screen clearly displays results.
- Auto buffer recognition, electrode condition icon, automatic temperature compensation and reference input all work to ensure accurate results.



- Application** pH, oxidation-reduction potential (ORP) measurement
- Display** Liquid crystal display (LCD)
- Operation** AC adapter (included)
- Construction** ABS housing, built-in electrode holder
- Design Features** Auto buffer recognition, two point calibration, quick reference guide

Model	Included Electrode	Measurement Range	Measurement Resolution	Item No.
ST2100-B	N/A	-2.00 to 16.00 pH; -1999 to 1999 mV; 1 to 100 °C	0.01 pH; 1 mV; 0.1 °C	30057494
ST2100-E	ST210			30057495
ST2100-F	ST210; STTEMP30			30057496

Accessories	Item No.
Holder, Stand Alone, Electrode	30058733
pH electrolyte	30059255
pH electrode protection	30059256
Buffer pH1.68 250 ml	30100424
Buffer pH4.01 250 ml	30100425
Buffer pH6.86 250 ml	30100426
Buffer pH7.00 250 ml	30100427
Buffer pH9.18 250 ml	30100428
Buffer pH10.01 250 ml	30100429
Buffer pH12.45 250 ml	30100440
Buffer Powder pH4.01;7.00;10.01	83033971

See page 224 for additional Starter Series Electrodes



Starter 300 pH Portable

Convenient Portable pH Meter for Wherever Your Work Takes You

- Automatic and manual temperature compensation ensures accurate readings while a 30 measurement library stores data for future reference.
- The auto buffer recognition stores calibration data and helps to avoid errors during the calibration process.
- With a meter stand, wrist strap for secure field use and IP54 housing, Starter 300 is durable and prepared for versatile use.

Application pH, oxidation-reduction potential (ORP) measurement

Display Liquid crystal display (LCD)

Operation 4 AAA batteries (included)

Construction ABS housing, wrist strap

Design Features 30 measurement memory, automatic and manual endpoint functions, automatic and manual temperature compensation



ST300-G

Model	Included Electrode	Measurement Range	Measurement Resolution	Item No.
ST300-B	N/A	0.00 to 14.00 pH; -1999 to 1999 mV ; 0 to 100 °C	0.01 pH ; 1 mV ; 0.1 °C	83033962
ST300	ST320			83033961
ST300-G				30219114

Accessories	Item No.
pH electrolyte	30059255
pH electrode protection	30059256
Portable Bag STARTER	30031635
Buffer pH1.68 250 ml	30100424
Buffer pH4.01 250 ml	30100425
Buffer pH6.86 250 ml	30100426
Buffer pH7.00 250 ml	30100427
Buffer pH9.18 250 ml	30100428
Buffer pH10.01 250 ml	30100429
Buffer pH12.45 250 ml	30100440
Seal kit, STARTER portables	83032962
Buffer Powder pH4.01;7.00;10.01	83033971

See page 224 for additional Starter Series Electrodes



Starter 300C Conductivity Portable

Convenient Portable Conductivity Meter for Wherever Your Work Takes You

- Starter 300C has a built-in temperature sensor and a 4-pole linear electrode that safeguards itself from polarization and pollution effects.
- With a simple calibration process and quick delivery of measurement results, Starter 300C is efficient and easy-to-use.
- The 30 item library allows the user to easily recall calibration data and stored information with one quick touch.



- Application** Conductivity, total dissolved solids (TDS) measurement
- Display** Liquid crystal display (LCD)
- Operation** 4 AAA batteries (included)
- Construction** ABS housing, wrist strap
- Design Features** Automatic temperature compensation, adjustable temperature coefficient



ST300C-G

Model	Included Electrode	Measurement Range	Measurement Resolution	Item No.
ST300C-B	N/A	00.0 μ S/cm to 199.9 mS/cm ; 0.1 mg/L to 199.9 g/L (TDS); 1 to 100 $^{\circ}$ C	0.01 μ S/cm; 0.1 mg/L ; 0.1 $^{\circ}$ C;	30092000
ST300C	STCON3			83033964
ST300C- G				30219115

Accessories	Item No.
Portable Bag STARTER	30031635
Standard Conduct 10 μ S/cm 250 ml	30100441
Standard Conduct 84 μ S/cm 250 ml	30100442
Standard Conduct 1413 μ S/cm 250 ml	30100443
Standard Conduct 12.88mS/cm 250 ml	30100444
Seal kit, STARTER portables	83032962
Portable Bag STARTER	30031635

See page 224 for additional Starter Series Electrodes

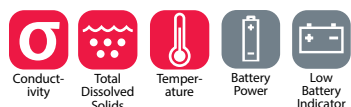

Starter 300D DO Portable

Convenient Portable Dissolved Oxygen Meter for Wherever Your Work Takes You

- The galvanic electrode can be used immediately after being powered on without the wait time typically associated with dissolved oxygen meters.
- With a simple calibration process, quick delivery of measurements and automatic temperature compensation, Starter 300D is both easy-to-use and accurate.
- 30 measurement storage endpoints allow the user to easily recall the last calibration data and stored information with one quick touch.



Application Dissolved Oxygen (DO) measurement

Display Liquid crystal display (LCD)

Operation 4 AAA batteries (included)

Construction ABS housing, wrist strap

Design Features 30 measurement memory



ST300D-G

Model	Included Electrode	Measurement Range	Measurement Resolution	Item No.
ST300D-B	N/A	% 0.0 to 199.9%; 200 to 400%;	0.1%; 1%;	30031656
ST300D	STDO11 ; STTEMP30	mg/L 0.00 to 19.99; 20.0 to 45.0 mg/L	0.01 mg/L; 0.1 mg/L;	30031655
ST300D-G	STDO11; STTEMP30	ppm 0.00 to 19.99; 20.0 to 45.0 ppm; 0 to 50 °C	0.01 ppm; 0.1 ppm; 0.1 °C	30219116

Accessories	Item No.
Portable Bag STARTER	30031635
Zero Oxygen Chemicals, STARTER	30059257
Seal kit, STARTER portables	83032962

See page 224 for additional Starter Series Electrodes

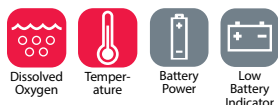

Starter 400D DO Portable

Dissolved Oxygen (DO) Meter with Optical Technology

- Optical DO Probe allows for minimal maintenance and permits for immediate measurement reading without the need for warm up time or any sample preparation.
- Large bright backlit LCD screen provides easy to read results even in low light areas, while 5 dedicated manual keys deliver simple, straightforward operation for all operators via a simple calibration process and accurate measurements.
- With a meter stand, wrist strap for secure field use and IP54 housing, Starter 400D is durable and prepared for versatile use.



Application Dissolved Oxygen measurement

Display Backlit Color Liquid Crystal Display (LCD)

Operation 4 AAA batteries (included)

Construction ABS housing, wrist strap

Design Features 99 measurement memory, last calibration data recall, auto barometric pressure measurement, auto temperature compensation with manual salinity compensation



Model	Included Electrode	Measurement Range	Measurement Resolution	Item No.
ST400D-B	—	0.0 to 200.0%	0.1% ; 0.01 mg/L; 0.1 °C	30378541
ST400D-G	STDO21 (Included)	0.00 to 20.0 mg/L(ppm)		30378542
ST400D		0 to 50 °C		30378543

Accessories	Item No.
Seal kit, STARTER portables	83032962
Zero Oxygen Chemicals, STARTER	30059257
DO Probe Cap, STD021	30253566
Portable Bag STARTER	30031635

See page 224 for additional Starter Series Electrodes

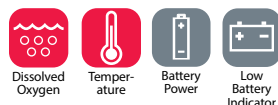

Starter Pen Meters

Accurate Electrochemistry Measurement At Your Fingertips

- Starter pen meters provide what should be expected of a small, economical pen meter: simple, fast, straightforward, no-frills operation time and time again.
- With durable ABS housing, a protective sensor cap, and automatic shutdown feature that preserves battery life, Starter pen meters can endure consistent use in rugged environments.
- Equipped with a wrist strap that prevents unintentional dropping, Starter pen meters are constructed with an IP67 waterproof design that can prevent water damage when dropped into liquid.



Application pH, oxidation-reduction potential (ORP), conductivity, total dissolved solids (TDS), salinity, dissolved oxygen (DO)

Display Liquid crystal display (LCD) display with secondary information line (on select models)

Operation 4 1.5V batteries (included)

Construction ABS Housing

Design Features Easily replaceable electrodes, automatic shut off feature



ST20D

Model	Meter Type	Measurement Range	Measurement Resolution	Temperature Display	Item No.
ST10	pH	0.00 – 14 pH	0.1 pH	Not Available	30073970
ST20		0.00 – 14 pH ; 0.0 – 99.0 °C	0.01 pH	Yes	30073971
ST20M-B	Multi	0.00 – 14pH, 0 – 1999 µS/cm, 0.0 – 1000 mg/L, 0.0 – 99.0 °C	0.01pH, 1µS/cm, 1 mg/L, 0.1°C	Yes	30393199
ST20M-C		0.00 – 14 pH, 0 - 19.99 mS/cm, 0.0 - 10.0 ppt, 0-99.0°C	0.01pH, 0.01mS/cm, 0.1 ppt, 0.1°C	Yes	30393200
ST10C-A	Conductivity	0.00 – 199.9 µS/cm	0.1 µS/cm	Not Available	30073972
ST10C-B		0 – 1999 µS/cm	1µS/cm		30073973
ST10C-C		0.00 – 19.99 ms/cm	10 µS/cm		30073974
ST20C-A		0.00 – 199.9 µS/cm ; 0.0 – 99.0 °C	0.1 µS/cm	Yes	30073975
ST20C-B		0 – 1999 µS/cm; 0.0 – 99.0 °C	1µS/cm		30073976
ST20C-C		0.00 – 19.99 ms/cm ; 0.0 – 99.0 °C	10 µS/cm		30073977
ST10T-A	TDS	0.0 – 100.0 mg/L	0.1 mg/L	Not Available	30073978
ST10T-B		0.0 – 1000 mg/L	1 mg/L		30073979
ST20T-A		0.0 – 100.0 mg/L; 0.0 – 99.0 °C	0.1 mg/L	Yes	30073980
ST20T-B		0.0 – 1000 mg/L; 0.0 – 99.0 °C	1 mg/L		30073981
ST10S	Salinity	0.0 – 10.0 ppt	0.1 ppt	Not Available	30073982
ST20S		0.0 – 80.0 ppt; 0.0 – 99.0 °C		Yes	30073983
ST10R	ORP	-1000 – 1000 mV	1 mV	Not Available	30073984
ST20R		-1000 – 1000 mV; 0.0 – 99.0 °C		Yes	30073985
ST20D	Dissolved Oxygen	0.0 – 80.0 ppt	0.1 mg/L	Yes	30073986

Accessories	Item No.
Zero Oxygen Chemicals, STARTER	30059257
Buffer pH4.01 250 ml	30100425
Buffer pH7.00 250 ml	30100427
Buffer pH10.01	30100429

Accessories	Item No.
Standard Conduct 84µS/cm 250 ml	30100442
Standard Conduct 1413µS/cm 250 ml	30100443
Standard Conduct 12.88mS/cm 250 ml	30100444
Membrane Kit Replaceable, ST20D	30222084

See page 229 for additional Laboratory Instrument Replacement Electrodes

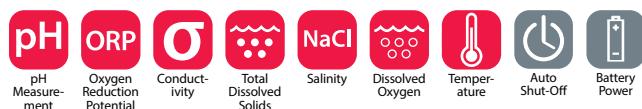

Starter Electrodes

OHAUS Precision Powers the Starter Electrodes

- Electrodes are constructed of glass or plastic and are built to withstand daily use.
- Select electrodes include a temperature sensor, which powers automatic temperature compensation and ensures accurate measurements.
- All electrodes fit perfectly in the electrode holders on OHAUS bench meters and electrode clips on all OHAUS portable meters.



Application pH, reference, oxidation-reduction potential (ORP), conductivity, dissolved oxygen (DO), temperature measurement

Construction Glass, plastic or metal

Design Features Can be used in conjunction with all Starter bench and portable meters

Model	ST5000, ST3100 & ST300	ST3100M	ST3100C & ST300C	ST300D	ST400D	Temperature	Shaft Material	Item No.
ST230	•	•					Glass	83033968
ST260	•	•					Glass	30129357
ST270	•	•					Glass	30240974
ST350	•	•				•	Glass	30129354
STMICR05	•	•					Glass	30087566
STMICR08	•	•					Glass	30087569
STPURE	•	•					Glass	83033969
STREF1	•	•					Glass	30059253
STREF2	•	•					Glass	30059254
STORP2	•	•					Glass	30038553
STORP1	•	•					Plastic	30038555
ST210	•	•					Plastic	83033966
ST272	•	•					Plastic	30393265
ST310	•	•				•	Plastic	83033965
ST320	•	•				•	Plastic	83033967
STSURF	•	•					Plastic	30129470
STCON3		•	•			•	Plastic	83033972
STCON7		•	•			•	Plastic	30080693
STD011				•			Plastic	30031639
STD021, 1m					•	•	Plastic	30378544
STD021, 5m					•	•	Plastic	30378545
STTEMP30	•	•		•		•	S.Steel	83033970

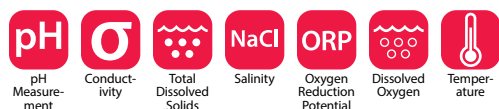

Bead Mill Homogenizer Accessories

Accessories	Item No.
White, Bacteria, 2mL tube, 100/box	30391402
Yellow, Yeast, 2mL Tube, 100/box	30391404
Blue, Fungi, 2mL Tube, 100/box	30391405
Orange, Soft Sample, 2mL Tube, 100/box	30391406
Green, Plant, 2mL Tube, 100/box	30391408
Red, Animal Tissue, 2mL Tube, 100/box	30391409
Brown, Environmental, 2mL Tube, 100/box	30391410
Tube Rack, 25 x 2ml Tubes, 2 per pack	30391431
Sample Tube Kit, 14 Tubes	30391433

Centrifuge Tube Adapters

Accessories	Item No.
Adapter, D6mm, 0.2/0.4ml Tubes x6	30130884
Adapter, D8mm, 0.5ml Tubes x6	30130885
Adapter, D11mm, 1.5/2.0ml Tubes x6	30130886
Adapter, D12.6mm, 1.0ml Cryo x6	30130887
Adapter, D12.6mm, 1.8ml Cryo x6	30130888
Adapter, D13.5mm, 7ml Tubes x2	30130889
Adapter, D13.5mm, 5ml Tubes x2	30130890
Adapter, D26mm, 30ml Tubes x2	30130891
Adapter, D18mm, 16ml Tubes x2	30130892
Adapter, D17mm, 15ml Tubes x2	30130893
Adapter, D17mm, 15ml RB Tubes x2	30130894
Adapter, 9x1.5/2.0ml D11mm, 2/pk	30304368
Adapter, 8x1.5ml D11mm, 2/pk	30304369
Adapter, 5x10ml D16mm RB, 2/pk	30304370
Adapter, 4x15ml D17mm FA, 2/pk	30304371
Adapter, 2x30ml D26mm RB, 2/pk	30304372
Adapter, 1x50ml D30mm RB, 2/pk	30304373
Adapter, 1x50ml D30mm FA, 2/pk	30304374
Adapter, 48x1.5/2.0ml D11mm, 2/pk	30314891
Adapter, 1x15ml D17.5mm FA, 2/pk	30314892
Adapter, 1x15ml D17mm RB, 2/pk	30314893
Adapter, 1x30ml D25mm RB, 2/pk	30314894
Adapter, 1x50ml D29mm RB, 2/pk	30314895
Adapter, 1x50ml D29mm FA, 2/pk	30314896
Adapter, 1x15ml D17mm FA, 2/pk	30314897
Adapter, 2x15ml D17mm RB, 2/pk	30314898
Adapter, 1x16ml D18mm RB, 2/pk	30314899
Adapter, 1x1.5ml for over 16000xg, 6/pk	30314900

Dry Block Heater Accessories

Accessories	Item No.
Test Tube Combination	30400156
Centrifuge Tube Combination	30400193
Micro-Tube Combination	30400194
12 x 15mL Conical Tube	30400172
5 x 50mL Conical Tube	30400168
2 x (12) 12.5 mm Cuvettes	30400161
2 Block Cover	30400179
4 Block Cover	30400180
6 Block Cover	30400181
30 x 0.5 mL Tube	30400157
20 x 1.5 mL Tube	30400159
20 x 1.5 mL Eppendorf™ Tube	30400162
20 x 2 mL Eppendorf™ Tube	30400191
20 x 2 mL Corning™ Tube	30400192
2 x 96-well PCR Plate	30400171
10 x 8 Tube Strips	30400169
64 x Individual PCR Tubes	30400170
Solid Block, Single	30400160
Solid Block, Double	30400166
30 x 6 mm Tube	30400158
24 x 10 mm Tube	30400151
20 x 12/13 mm Tube	30400152
16 x 12/13 mm Tube	30400165
12 x 15/16 mm Tube	30400153
12 x 17/18 mm Tube	30400195
8 x 20 mm Tube	30400154
6 x 25 mm Tube	30400155
4 x 35 mm Tube	30400167
Sand Bath, 1 Block Dry Block Heater	30400173
Sand Bath, 2 Block Dry Block Heater	30400174
Sand Bath, 4 Block Dry Block Heater	30400175
Sand Bath, 6 Block Dry Block Heater	30400176
Sand, 1 lb (0.45 kg)	30400177
Stainless Steel Shot, 1 lb (0.45 kg)	30400178
Titer Plate	30400164

Dry Block Heater Accessories

Accessories	Item No.
20 x 12 mm Vial	30400182
20 x 15 mm Vial	30400183
16 x 16 mm Vial	30400190
12 x 17 mm Vial	30400184
12 x 19 mm Vial	30400185
9 x 21 mm Vial	30400186
8 x 23 mm Vial	30400187
8 x 25 mm Vial	30400188
6 x 28 mm Vial	30400189

Extreme Environment and Heavy Duty Shaker Accessories

Accessories	Item No.
18 x 18" (45.7 x 45.7 cm) Culture Platform	30400066
18 x 24" (45.7 x 61 cm) Culture Platform	30400067
13 x 13" (33 x 33 cm) Dedicated Platform / 125 mL Flask Clamp	30400075
13 x 13" (33 x 33 cm) Dedicated Platform / 250 mL Flask Clamp	30400076
13 x 13" (33 x 33 cm) Dedicated Platform / 500 mL Flask Clamp	30400077
13 x 13" (33 x 33 cm) Dedicated Platform / 1 L Flask Clamp	30400078
18 x 18" (45.7 x 45.7 cm) Dedicated Platform / 125 mL Flask Clamp	30400079
18 x 18" (45.7 x 45.7 cm) Dedicated Platform / 250 mL Flask Clamp	30400080
18 x 18" (45.7 x 45.7 cm) Dedicated Platform / 500 mL Flask Clamp	30400081
18 x 18" (45.7 x 45.7 cm) Dedicated Platform / 1 L Flask Clamp	30400082
18" (45.7 cm) Adjustable Bar (with Mounting Hardware)	30400083
Two-Tier Braces (set of 4)	30400051

Equipment & Instrument Accessories Frontier Multi Pro Centrifuge Accessories

Accessories	Price USD
Bucket, 100ml w/o Cap, 2/pk	30314860
Bucket, 100ml w/ Cap, Sealable, 2/pk	30314861
Screw Cap, 100ml Bucket, Sealable, 2/pk	30314862
O-ring, 100ml Bucket, Sealable, 10/pk	30314863
Bucket, 2x50ml D29mm FA, w/ Rack, 2/pk	30314881
Bucket, 3x15ml D17mm FA, w/ Rack, 2/pk	30314882
Bucket, 3xMTP, 2/pk	30314890
Rack, 8x4-10ml D16mm Vac, 2/pk	30304367
Rack, 4x50ml D29mm FA, 2/pk	30304375
Rack, 10x15ml D17mm FA, 2/pk	30314583
Rack, 14x5-7ml D13mm Vac/Sar, 2/pk	30314584
Rack, 12x4-10ml D16mm Vac/Sar, 2/pk	30314585
Rack, 1x100ml D46mm RB, 2/pk	30314842
Rack, 1x85ml D38mm RB, 2/pk	30314843
Rack, 1x50ml D34mm RB, 2/pk	30314844
Rack, 1x50ml D29mm RB, 2/pk	30314845
Rack, 1x50ml D29mm FA, 2/pk	30314846
Rack, 1x50ml D29mm Rim, 2/pk	30314847
Rack, 1x30ml D25mm Rim, 2/pk	30314848
Rack, 1x25ml D25mm RB, 2/pk	30314849
Rack, 2x15ml D17mm FA, 2/pk	30314850
Rack, 1x15ml D17mm Rim, 2/pk	30314851
Rack, 7x15ml D17mm RB, 2/pk	30314852
Rack, 9x5-7ml D13mm RB, 2/pk	30314853
Rack, 10x1.5ml D11mm, 2/pk	30314854
Rack, 9x4.5ml D12mm FB, 2/pk	30314855
Rack, 7x5-7ml D13mm RB, 2/pk	30314856
Rack, 7x5-7ml D13mm Vac, 2/pk	30314857
Rack, 5x4-10ml D16mm Sar, 2/pk	30314858
Rack, 1x100ml D40mm RB, 2/pk	30314864
Rack, 1x85ml D38mm RB, 2/pk	30314865
Rack, 1x50ml D34mm RB, 2/pk	30314866
Rack, 1x50ml D29mm RB, 2/pk	30314867
Rack, 1x50ml D29mm FA, 2/pk	30314868
Rack, 1x50ml D29mm Rim, 2/pk	30314869
Rack, 1x30ml D25mm Rim, 2/pk	30314870
Rack, 1x25ml D25mm RB, 2/pk	30314871
Rack, 1x15ml D17mm FA, 2/pk	30314872
Rack, 2x15ml D17mm FA, 2/pk	30314873
Rack, 2x15ml D17mm Rim, 2/pk	30314874
Rack, 4x15ml D17mm RB, 2/pk	30314875
Rack, 7x5-7ml D13mm RB, 2/pk	30314876
Rack, 5x1.5ml D11mm, 2/pk	30314877
Rack, 3x10ml D17mm Sar, 2/pk	30314878
Rack, 4x5-7ml D13mm RB, 2/pk	30314879
Rack, 4x10ml D17mm Vac, 2/pk	30314880

Frontier Multi Pro Centrifuge Accessories

Accessories	Item No.
Screw Cap, Rack of 250ml Rotor, 2/pk	30314901
O-ring, Rack of 250ml Rotor, 10/pk	30314902
Rack, 1x250ml D62mm FB, 2/pk	30314903
Rack, 1x100ml D41mm RB, 2/pk	30314904
Rack, 3x50ml D29mm RB, 2/pk	30314905
Rack, 3x50ml D29mm FA, 2/pk	30314906
Rack, 1x50ml D34mm RB, 2/pk	30314907
Rack, 2x50ml D29mm Rim, 2/pk	30314908
Rack, 1x50ml D29mm Rim, 2/pk	30314909
Rack, 5x25ml D24.5mm RB, 2/pk	30314910
Rack, 3x25ml D24.5mm Rim, 2/pk	30314911
Rack, 9x15ml D17mm RB, 2/pk	30314912
Rack, 7x15ml D17mm FA, 2/pk	30314913
Rack, 7x15ml D17mm Rim, 2/pk	30314914
Rack, 8x10ml D16mm RB, 2/pk	30314915
Rack, 14x5-7ml D13mm RB, 2/pk	30314916
Rack, 10x1.6-7ml D13mm Vac, 2/pk	30314917

Heavy Duty Shaker Accessories

Accessories	Item No.
4-bar Large Vessel Carrier Platform	30400070
4-bar Large Vessel Carrier Platform	30400071
5-bar Large Vessel Carrier Platform	30400072

Heavy Duty Vortex Mixer Accessories

Accessories	Item No.
Foam insert for 0.5 mL microtubes	30400216
Foam insert for 1.5 to 2.0 mL microtubes	30400217
Foam insert for 12-13 mm test tubes	30400220
Foam insert for 15-18 mm test tubes	30400221
Foam insert for 19-21 mm test tubes	30400222
Foam insert for 22-25 mm test tubes	30400223
Foam insert for 26-29 mm test tubes	30400224

Heavy Duty Vortex Mixer Accessories

Accessories	Item No.
Flat Foam Insert	30400209
Large Vessel Holder	30400211
Microplate Single Holder	30400215
Microplate Double Holder	30400213
Microplate Quad Holder	30400214
Small Vessel Holder	30400218
Universal Holder	30400226
Universal Holder Cover	30400225
Stackable Microplate Holder	30400212

Incubating Cooling Thermal Shaker Accessories

Accessories	Item No.
24 x 2.0 mL Cryotubes	30400133
30 x 0.5 mL Microtubes	30400129
24 x 1.5 mL Microtubes	30400130
24 x 2.0 mL Microtubes	30400131
24 x 5-7 mL Tubes	30400132
Microplate Thermal Block with Lid	30400126
384 Well Plate Thermal Block with Lid	30400127
0.2 mL PCR Plate Thermal Block with Lid	30400128
5 mL Eppendorf Tube Block	30400134
15 mL Conical Tubes	30400135
50 mL Conical Tubes	30400136

Light Duty Shaker Accessories

Accessories	Item No.
8.6" (21.8 cm) Adjustable Bar (with Mounting Hardware)	30400122
18" (45.7 cm) Adjustable Bar (with Mounting Hardware)	30400073
2-bar Adjustable Platform	30400121
4-bar Adjustable Platform	30400068
4-bar Adjustable Platform	30400069
18" (45.7 cm) Adjustable Bar (with Mounting Hardware)	30400073
24" (61 cm) Adjustable Bar (with Mounting Hardware)	30400074
Dilution Cup Tray	30400125
Universal Harness	30400123

Mini Vortex Mixer Accessories

Accessories	Item No.
Single Tube Holder	30400202
Cup Head	30400210
Cup Head	30400235
Micro-Tube Holder (0.5 mL)	30400204
Microtube Holder (1.5 mL to 2.0 mL)	30400205
9 to 13 mm Tube Holder (2 pack)	30400229
14 to 19 mm Tube Holder (2 pack)	30400230
20 to 25 mm Tube Holder (2 pack)	30400231
3" (7.6 cm) Rubber Head Cover	30400196
3" (7.6 cm) Head	30400236
3" (7.6 cm) Head with Rubber Cover	30400237
15 to 17 mm Ampule Tube Holder	30400207
10 to 17 mm Ampule Tube Holder	30400208
Adapter Plate For Vortex-Genie® Mixer	30400203
Flat Foam Insert (2 pack)	30400234
Insert Retainer	30400227
Foam Insert Variety Pack	30400201
Microplate Holder (2 pack)	30400233
Micro-Tube Holder (2 pack)	30400232
Micro-Tube & Microplate Holder Kit	30400198
Microtube Kit with /Retainer	30400200
Microwell Kit with Retainer	30400199
Rack For 30 X 0.5 mL Tube Block	30400250
Rack For 24X1.5 / 24X2.0 mL Tube Blocks	30400251
Cover For 0.5mL/1.5mL/2.0mL Tube Blocks	30400252
Microtube Holder	30400206
Vessel Harness (2 pack)	30400228
Tube Holder Kit	30400197

Multi-Tube Vortex Mixer Accessories

Accessories	Item No.
50 x 10 mm Test Tube Foam Rack	30400238
50 x 12 mm Test Tube Foam Rack	30400239
50 x 13 mm Test Tube Foam Rack	30400240
50 x 16 mm Test Tube Foam Rack (for 15 mL centrifuge tubes)	30400241
28 x 25 mm Test Tube Foam Rack	30400243
15 x 29 mm Test Tube Foam Rack (for 50 mL centrifuge tubes)	30400242
Replacement Tray Pad Set (upper & lower)	30400245
Post Extension Kit	30400244

Equipment & Instrument Accessories Open Air and Incubating Shaker Accessories

Accessories	Platform Item No.
11 × 13 Platform (4 Microplate Clamps)	30400052
13 × 13 Platform (6 Microplate Clamps)	30400053
18 × 18 Platform (12 Microplate Clamps)	30400054
18 × 24 Platform (18 Microplate Clamps)	30400056
18 × 30 Platform (21 Microplate Clamps)	30400057
24 × 24 Platform (24 Microplate Clamps)	30400058
24 × 36 Platform (36 Microplate Clamps)	30400059
Microplate Clamp	30400104
Stacking Tray, 12.75 × 10" (32.4 × 25.4 cm)	30400114
10 mL Erlenmeyer Flask Clamp	30400084
25 mL Erlenmeyer Flask Clamp	30400085
50 mL Erlenmeyer Flask Clamp	30400086
125 mL Erlenmeyer Flask Clamp	30400087
250 mL Erlenmeyer Flask Clamp	30400088
500 mL Erlenmeyer Flask Clamp	30400089
1 L Erlenmeyer Flask Clamp	30400090
2 L Erlenmeyer Flask Clamp	30400091
2.8 L Fernbach Flask Clamp	30400092
3 L Fernbach Flask Clamp	30400093
4 L Erlenmeyer Flask Clamp	30400094
5 L Erlenmeyer Flask Clamp	30400095
11 × 13" (27.9 × 33 cm) Rubber Mat	30400060
13 × 13" (33 × 33 cm) Rubber Mat	30400061
18 × 18" (45.7 × 45.7 cm) Rubber Mat	30400062
18 × 24" (45.7 × 61 cm) Rubber Mat	30400063
24 × 24" (61 × 61 cm) Rubber Mat	30400064
24 × 36" (61 × 91.4 cm) Rubber Mat	30400065
6 L Erlenmeyer Flask Clamp	30400096
500 mL Media Bottle Clamp	30400097
1 L Media Bottle Clamp	30400098
125 mL Erlenmeyer Flask Clamp	30400099
250 mL Erlenmeyer Flask Clamp	30400100
500 mL Erlenmeyer Flask Clamp	30400101
1 L Erlenmeyer Flask Clamp	30400102
2 L Erlenmeyer Flask Clamp	30400103

Open Air and Incubating Shaker Accessories

Accessories	Item No.
1.5 to 2 mL Micro-Tube Rack Half Size, Stationary	30400114
10 to 13 mm Test Tube Rack Half Size, Stationary	30400115
14 to 16 mm Test Tube Rack Half Size, Stationary	30400116
18 to 20 mm Test Tube Rack Half Size, Stationary	30400117
22 to 25 mm Test Tube Rack Half Size, Stationary	30400118
15 mL Centrifuge Tube Rack Half Size, Stationary	30400119
50 mL Centrifuge Tube Rack Half Size, Stationary	30400120
10 to 14 mm Test Tube Rack Full Size, Stationary	30400110
16 to 20 mm Test Tube Rack Full Size, Stationary	30400111
21 to 25 mm Test Tube Rack Full Size Stationary	30400112
50 mL Centrifuge Tube Rack Full Size, Stationary	30400113
13 mm Test Tube Rack Full Size, Pivoting	30400105
16 mm Test Tube Rack Full Size, Pivoting	30400106
20 mm Test Tube Rack Full Size, Pivoting	30400107
25 mm Tube Rack Full Size, Pivoting	30400108
30 mm Tube Rack Full Size, Pivoting	30400109
11 × 13" (27.9 × 33 cm) Universal Platform	30400052
13 × 13" (33 × 33 cm) Universal Platform	30400053
18 × 18" (45.7 × 45.7 cm) Universal Platform	30400054
18 × 24" (45.7 × 61 cm) Universal Platform	30400056
24 × 24" (61 × 61 cm) Universal Platform	30400057
18 × 30" (45.7 × 76.2 cm) Universal Platform	30400058
24 × 36" (61 × 91.4 cm) Universal Platform	30400059
Two-Tier Braces (set of 4)	30400051

Laboratory Instrument Accessories

Accessories	Item No.
Pen Meter Electrode pH10 ST	30087992
Pen Meter Electrode pH20 ST	30087993
Pen Meter Electrode ST20M-B	30393203
Pen Meter Electrode ST20M-C	30393204
Pen Meter Electrode CT10A ST	30087994
Pen Meter Electrode CT10B ST	30087995
Pen Meter Electrode CS10C ST	30087996
Pen Meter Electrode CT20A ST	30087997
Pen Meter Electrode CT20B ST	30087998
Pen Meter Electrode CS20C ST	30087999
Pen Meter Electrode R10 ST	30088020
Pen Meter Electrode R20 ST	30088021
Pen Meter Electrode ST20D	30222083
pH electrolyte (KCl saturated AgCl, 30ml)	30059255
pH electrode protection solution(3M KCl)	30059256
pH sensor protect bottle(10 in bag)	30064800
Zero Oxygen Chemicals, STARTER	30059257
Buffer pH1.68 250 ml	30100424
Buffer pH4.01 250 ml	30100425
Buffer pH6.86 250 ml	30100426
Buffer pH7.00 250 ml	30100427
Buffer pH9.18 250 ml	30100428
Buffer pH10.01 250 ml	30100429
Buffer pH12.45 250 ml	30100440
Standard Conduct 10 µs/cm 250 ml	30100441
Standard Conduct 84 µs/cm 250 ml	30100442
Standard Conduct 1413 µs/cm 250 ml	30100443
Standard Conduct 12.88 mS/cm 250 ml	30100444
Buffer Powder pH4.01; 7.00; 10.01	83033971

Rocking and Waving Shaker Accessories

Accessories	Item No.
Dimpled Mat, 12.75 × 10" (32.4 × 25.4 cm)	30400140
Dimpled Mat, 11.75 × 8.75" (29.9 × 22.2 cm)	30400142
Dimpled Mat, 10 × 7.5" (25.4 × 19.1 cm)	30400141
Dimpled Mat, 9.25 × 7.25" (23.5 × 18.4 cm)	30400143
Dimpled Mat, 11.75 × 8.75" (29.9 × 22.2 cm)	30400124
Dimpled Mat, 14 × 11" (35.6 × 27.9 cm)	30400144
Stacking Tray, 12.75 × 10" (32.4 × 25.4 cm)	30400137
Stacking Tray, 11.75 × 8.75" (29.9 × 22.2 cm)	30400138
Stacking Tray, 14 × 11" (35.6 × 27.9 cm)	30400139

U.S. and Canada

Terms are net 30 days, FOB Worthington, Ohio USA, a service charge of 1.5% will be applied on invoice amounts past due 30 days • All orders for immediate release • No cancellations within 48 hours of acknowledged ship date • Prices, terms & specifications subject to change without prior notice • Drop shipments not available in Canada • OHAUS Corporation's products are warranted against defects in materials & workmanship from date of delivery through duration of the warranty period. During the warranty period OHAUS will repair, or, at its option, replace any component(s) that proves to be defective at no charge, provided that the product is returned, freight prepaid, to OHAUS Corporation. All other approved returns require issuance of a Return Order number from Parsippany, NJ, USA and may be subject to a 20% restocking fee. This warranty does not apply if the product has been damaged by accident or misuse, exposed to radioactive or corrosive materials, has foreign material penetrating to the inside of the product, or as a result of service or modification by other than the OHAUS Corporation or an authorized OHAUS Regional Service Center. This warranty only covers products shipped within the United States and to Canada by OHAUS Corporation to the dealer within the United States and in Canada. The warranty period for OHAUS products shall begin at the date of shipment to the end-user, or 3 months from the date of shipment to the dealer by OHAUS Corporation, whichever occurs first. A properly completed Warranty Registration Form must be received by OHAUS Corporation or product may be registered at www.ohaus.com within 30 days from the date of purchase to initiate coverage under the warranty. No other expressed or implied warranty is given by OHAUS Corporation. OHAUS Corporation shall not be liable for any consequential damages.

Outside U.S. and Canada

Payment terms: As per agreement • All prices Ex-Factory, Worthington, Ohio USA • Service charge of 1.5% will be applied on invoice amounts past due • All approved returns require issuance of a Return Order number from Parsippany, NJ, USA • Restocking fee 20% of dealer net • Minimum order: \$50.00 • All orders for immediate release • No cancellations within 48 hours of acknowledged ship date • Prices, terms & specifications subject to change without prior notice.

Business Partner Code of Conduct

OHAUS is committed to conducting its business ethically, legally and in a socially responsible manner. We expect our business partners and Dealers to share this commitment and we have therefore developed this Business Partner Code of Conduct. It covers Ethical Conduct, Fair Competition, Environment, Health and Safety, as well as Labor Practices. This code applies to all your activities in your business relationship with us. It defines the minimum standards of business conduct we expect you to comply with in your business relationship with OHAUS. You must also comply with all applicable laws, regulations, and codes of the countries in which you operate. We encourage you to work with your own business partners to ensure they also strive to meet the principles of this code, or equivalent principles. For more information and to view the whole code, please visit ohaus.com/business-partner.

Six Month Warranty			Three Year Warranty
Starter Series Electrodes			Harvard Junior® Balances
One Year Warranty			TJ611 Balance
Accessories	Hand Held Scales	SD & Catapult Scales	Five Year Warranty
Aviator® Scales	Indicators, all models	Spring Scales	All Other Mechanical Balances
CS & CL Scales	JE Emerald & JR Ruby Scales	Starter Series Meters	Ten Year Warranty
D500 Beam Scales	MB25 with MB27	TAJ Scales	Triple Beam Pro® Balances
Defender® Scales	Navigator® Scales	Valor® Scales	
CKW Scales	Primer® Balance	VX & VN Floor Scales	
ES Scales	PS Scales	Weights & Weight Sets	
FD Scales	Ranger® Scales	Y Series Scales	
Frontier Mini Centrifuge	Scale Bases, all models		
Two Year Warranty			
Adventurer® Balances	MB90 & MB120	Scout® STX , SPX & SJX Balances	
Explorer® Balances	Pioneer® & PAJ Balances	Vortex Mixers	
Hotplates & Stirrers	Dry Block Heaters	Homogenizers	
Open Air Shakers	Incubating & Incubating	Frontier Micro & Multi Centrifuges	
Labjaws Clamps & Supports	Cooling Shakers		

Any product not listed above includes a one year warranty

All replacement parts include a 90 day warranty

The following product names, features and services are trademarks owned by OHAUS® Corporation, and are protected by international copyright laws. Those trademarks followed by (®) are registered trademarks of OHAUS Corp. ; all others are trademarks of OHAUS Corp. The appropriate (®) or (™) mark should appear with its appropriate name as governed by law. Registered Trademarks: Adventurer®, Aviator®, Catapult®, Cent-O-Gram®, Defender®, Dial-O-Gram®, Explorer®, Navigator®, OHAUS®, Pioneer®, Primer®, Ranger®, Scout®, Triple Pro®, Trooper®, Valor®, Voyager®. Trademarks: AutoCal™, Caltest™, Champ™, FillGuide™, Harvard Junior™, InCal™, Maxi-Scoop™, Modular Concept™, Moveable FineRange™, ProgramLink™, QuadraStance™, ScientificStoreroom™, SmarText™, Traveler™, Weigh the Benefits™. Permission is required to reproduce the OHAUS Logo or OHAUS trademarks for use in printed materials or for electronic transmission. Please contact OHAUS Marketing Communications for permission.

OHAUS Minimum Advertised Price (MAP) Policy

OHAUS Corporation has adopted this Minimum Advertised Price (MAP) policy to protect the reputation of its brand name, better serve our customers, and in order to properly position the OHAUS brand in the marketplace. OHAUS products which are subject to this MAP policy are defined below. This Policy has been unilaterally adopted and will be enforced strictly and uniformly.

- Resellers are free to establish their own resale prices; however, they should not advertise OHAUS products below the minimum advertised prices set by OHAUS Corporation.
- Advertising includes any form of providing information about pricing that is not associated with the act of purchasing or negotiating the purchase of a product. Examples of advertising include, but are not limited to, signage, catalogs, displays, mailings, flyers, internet advertisements, internet price lists, and internet “click here” links or pop-ups and similar web-based techniques. For purposes of this policy, advertising does not include responses to email inquiries, verbal communications, or prices displayed in internet “shopping carts” or “baskets.”
- A Reseller shall not state or suggest in advertising or on a web site that a price lower than the MAP for an OHAUS product may be available during an online checkout or purchase process, including but not limited to the following: “click here for lower price,” “add to cart for discounted price,” or “price too low to advertise.” It shall not be a violation of this Policy for a Reseller to indicate that a different actual selling price is available and visible in a “shopping cart” or “basket” or as part of a sales transaction, provided these advertising restrictions are observed and no statement or suggestion of lower or discounted prices is made.
- Each Reseller shall ensure that any and all agents, service providers, and other parties it contracts with for the Reseller’s sale of OHAUS products comply with this MAP policy. Resellers shall not post OHAUS products for sale in any online or other marketplace if such a posting will result in the advertisement, by the Reseller or by the marketplace, of prices below the MAPs set by OHAUS.
- OHAUS Corporation will periodically monitor the resale market to ensure dealers are in compliance with the MAPs set by OHAUS.
- Upon verification that such dealer has advertised any of OHAUS Corporation’s products at a price less than the minimum advertised price established and announced by OHAUS Corporation from time to time (the “MAP”), OHAUS will, without assuming any liability, cancel all orders and will indefinitely refuse to accept any new orders from any reseller immediately.
- This Policy does not apply to refurbished or discontinued OHAUS products.
- It may be modified at any time by OHAUS Corporation, and the minimum advertised price may be affected by promotional periods designated by OHAUS Corporation.
- This Policy has been established unilaterally by OHAUS Corporation. No dealer’s consent or agreement to this Policy is sought, nor will such consent or agreement be accepted by OHAUS Corporation. OHAUS Corporation is providing this Policy to dealers strictly as notice of such Policy.
- The minimum advertised prices (MAPs) effective January 1, 2019 are set forth in the schedule below, exclusive of all state and local taxes.

Product Series	MAP Price % off List Price
Explorer® Series	15%
Adventurer® / Pioneer™ / PAJ Series	15%
Moisture Analyzers (MB) Series	15%
Scout® Series / SJX / TAJ Series	30%
Hand Held / CL Series/ PS Series	40%
Compact CS / Ruby Series	25%
Mechanicals (all)	25%
Starter Series Portable / Bench Meters	15%
Starter Series Pen Meters	20%
Replacement Electrodes	15%
Frontier 5306 Centrifuge	25%
Spring Scales	20%
Frontier Micro & Multi Centrifuges / Hotplates & Stirrers / Dry Block Heaters / Vortex Mixers / Open Air Shakers / Incubating & Incubating Cooling Shakers / Homogenizers / Labjaws Clamps & Supports	15%

Product Series	MAP Price % off List Price
Valor® Series	15%
FD Series	20%
Navigator® Series	20%
Defender® 7000 / 5000 / 3000	20%
NEW Defender® 5000	10%
CKW Series	10%
Emerald / YJ / YA Series	40%
ES Series	20%
SD / Catapult Series	25%
Ranger® 7000 Series	20%
Ranger / Ranger Count 3000 Series	25%
Ranger / Ranger Count 4000 Series	25%
Aviator® Series	30%
Industrial Indicators and Bases	0%
VN/VX Floor Scales	30%
Weights and Accessories	10%

OHAUS Partner Shop

The recently improved OHAUS Partner Shop is purposefully aimed at delivering a better shopping experience. We've added some great new features, making it easier to use and quicker to navigate. With advanced search capabilities, a convenient comparison function, and an order template designed to help you anticipate and quickly execute all of your ordering needs, the OHAUS Partner Shop was designed with you and your customers in mind.

Why Use OHAUS Partner Shop?

- Online Ordering
- View Product Availability and Pricing
- View Order Status
- Track Shipments
- View Invoices

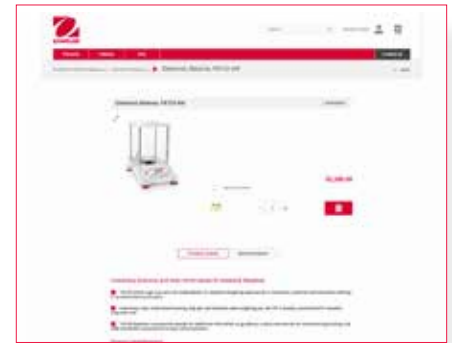

Contact your OHAUS representative today to experience our Partner Shop!

Contact us

Ordering

We welcome your orders however you choose to place them! In addition to our online dealer-dedicated site (us.partnershop.ohaus.com) you may also

- Email your order to sales@ohaus.com or
- Fax your order to [973-944-7177](tel:973-944-7177)

Dealer Support

We are here to support your sales! Our Customer Service Team is happy to help with any of your questions.

- Email your inquiries to cs@ohaus.com or
- Call us at [1-800-672-7722](tel:1-800-672-7722) and press 1 to reach a Customer Service Representative

Technical Support

Having technical trouble or questions on how to operate your OHAUS equipment? Contact one of our Technical Support Specialists to assist you with your technical needs.

- Call us at [1-800-672-7722](tel:1-800-672-7722) and press 2 for Technical Support, or
- Email your question to TechService@OHAUS.com

Dealer Support

Dealer Zone

OHAUS.com's Dealer Zone is your one-stop resource center for marketing, sales, and service support designed to help you grow your business. Featuring a comprehensive collection of e-launch kits, product information and photos, service and support assistance, promotions, events, and much more, the OHAUS Dealer Zone is a fully-loaded, constantly updated website that allows access to every kind of marketing support. From customizable marketing email templates to product pricing and specifications, the OHAUS Dealer Zone takes the guesswork out of your sales and marketing experience, and gives you the tools you need to keep your own OHAUS materials as up-to-date and effective as possible.

Why Use OHAUS Dealer Zone?

Update your website and catalog with simple access to

- Product photos in a variety of formats (jpg, tif, 360° spins)
- Web banners for products and promotions
- Product videos for both overview tutorials as well as popular applications
- The OHAUS Magic Spreadsheet for in-depth product specifications

Downloadable content for marketing assistance, such as

- Promotional flyers
- Customizable email templates to send your customers
- Product-related infographics for a wide range of industries and applications
- Up-to-date OHAUS catalogs and brochures

One-click access to essential documents, including

- Service and instruction manuals
- Up-to-date documents and software for OHAUS products
- Service and support FAQ
- Comprehensive adapter lists and cable guides for OHAUS products



OHAUS Service and Product Training Seminars

Several times a year, OHAUS offers its authorized dealers a Service Training Seminar, held at our facility in Parsippany, NJ. The seminar lasts three days and covers a mix of troubleshooting, load cell repair / replacement, and common problems. The emphasis will be placed on the practical side of balance repair.

We also offer product-specific training seminars, in the form of both webinar and on-demand technical trainings on our full portfolio of weighing and laboratory equipment. These trainings offer an in-depth look at the functionality and capability of our product offerings, bettering your sales abilities.

If you are interested in finding out more about these training seminars, please contact us at

TechService@OHAUS.com

OHAUS Document Exchange System

A comprehensive repository of sales materials, product information, and promotions, the OHAUS Document Exchange system (better known as DMX) is your one-stop shop for everything OHAUS. Register today, by visiting

<http://dmx.ohaus.com/>

Applications



Features



Approvals





Laboratory Weighing



Laboratory Equipment



Industrial Weighing



Portable Balances



Laboratory Instruments



Calibration Weights



OHAUS CORPORATION
*7 Campus Drive
Suite 310
Parsippany, NJ 07054 USA

Tel: 800.672.7722
973.377.9000
Fax: 973.944.7177
www.ohaus.com

*With offices throughout
Europe, Asia, and
Latin America*

***ISO 9001:2015**
Registered Quality
Management System

Ingeniously Practical