

° LAUDA



OVERALL BROCHURE
CONSTANT TEMPERATURE EQUIPMENT
2022/2023

°FAHRENHEIT. °CELSIUS. °LAUDA.

LAUDA

Worldwide

LAUDA-Noah, LP

2501 SE Columbia Way, Suite 140
Vancouver, WA 98661 • USA
T +1 360 993 1395 • info@lauda-noah.com

LAUDA-Brinkmann, LP

1819 Underwood Boulevard • Delran, NJ 08075 • USA
308 Digital Drive • Morgan Hill, CA 95037 • USA
T +1 856 764 7300 • info@lauda-brinkmann.com

LAUDA América Latina Tecnología Ltda.

Av. Paulista, 726 – 17º andar – Cj. 1707
01310-910 – São Paulo • SP Brazil
T +55 11 3192-3904 • info@lauda.net.br

LAUDA Ultracool S.L.U.

Carretera de Rubí, 316 • 08228 Terrassa (Barcelona) • Spain
T +34 93 7854866 • info@lauda-ultracool.com

LAUDA Ibérica Soluciones Técnicas, S.L.U.

Carretera de Rubí, 316 • 08228 Terrassa (Barcelona) • Spain
T +34 93 7854866 • info@lauda-iberica.es





LAUDA Technology Ltd.

Unit 12 · Tinwell Business Park
Stamford PE9 3UN · United Kingdom
T +44 (0)1780 243 118 · info@lauda-technology.co.uk

LAUDA DR. R. WOBSE GMBH & CO. KG

Burgwedel Subsidiary

Schulze-Delitzsch-Straße 4 · 30938 Burgwedel
Germany · T +49 (0) 5139 9958-0 · info@lauda.de

OOO ›LAUDA Wostok‹

Malaja Pirogowskaja Str. 5 · 119435 Moscow
Russia · T +7 495 9376562 · info@lauda.ru

LAUDA Italia S.r.l.

Strada 6 – Palazzo A – Scala 13
20090 Assago Milanofiori (MI) · Italy
T +39 02 9079194 · info@lauda-italia.it

LAUDA France S.A.R.L.

ZAC du Moulin · 25 rue Noyer · CS 11621
95724 Roissy Charles de Gaulle Cedex · France
T +33 (0)1 39926727 · info@lauda.fr

LAUDA DR. R. WOBSE GMBH & CO. KG

Laudaplatz 1 · 97922 Lauda-Königshofen
Germany · T +49 (0)9343 503-0 · info@lauda.de

LAUDA Medical GmbH & Co. KG

T +49 (0)9343 503-345 · info@lauda-medical.com

LAUDA Scientific GmbH

T +49 (0)9343 503-190 · info@lauda-scientific.de

new.degree GmbH · The LAUDA Innovation Lab

T +49 (0)9343 503-333 · info@new.degree

LAUDA Production China Co., Ltd.

Room A , 2nd floor, Building 6 · No. 201 MinYi Road
Song Jiang District · 201612 Shanghai · China
T +86 10 57306210 · info@lauda.cn

LAUDA China Co., Ltd.

2nd floor, Building 6 · No. 201 MinYi Road
Song Jiang District · 201612 Shanghai · China
T +86 21 64401098 · info@lauda.cn

LAUDA Singapore Pte., Ltd.

25 International Business Park · #04-103M German Centre
Singapore 609916 · Singapore · T +65 6563 0241 · info@lauda.sg

LAUDA

A world market leader with tradition

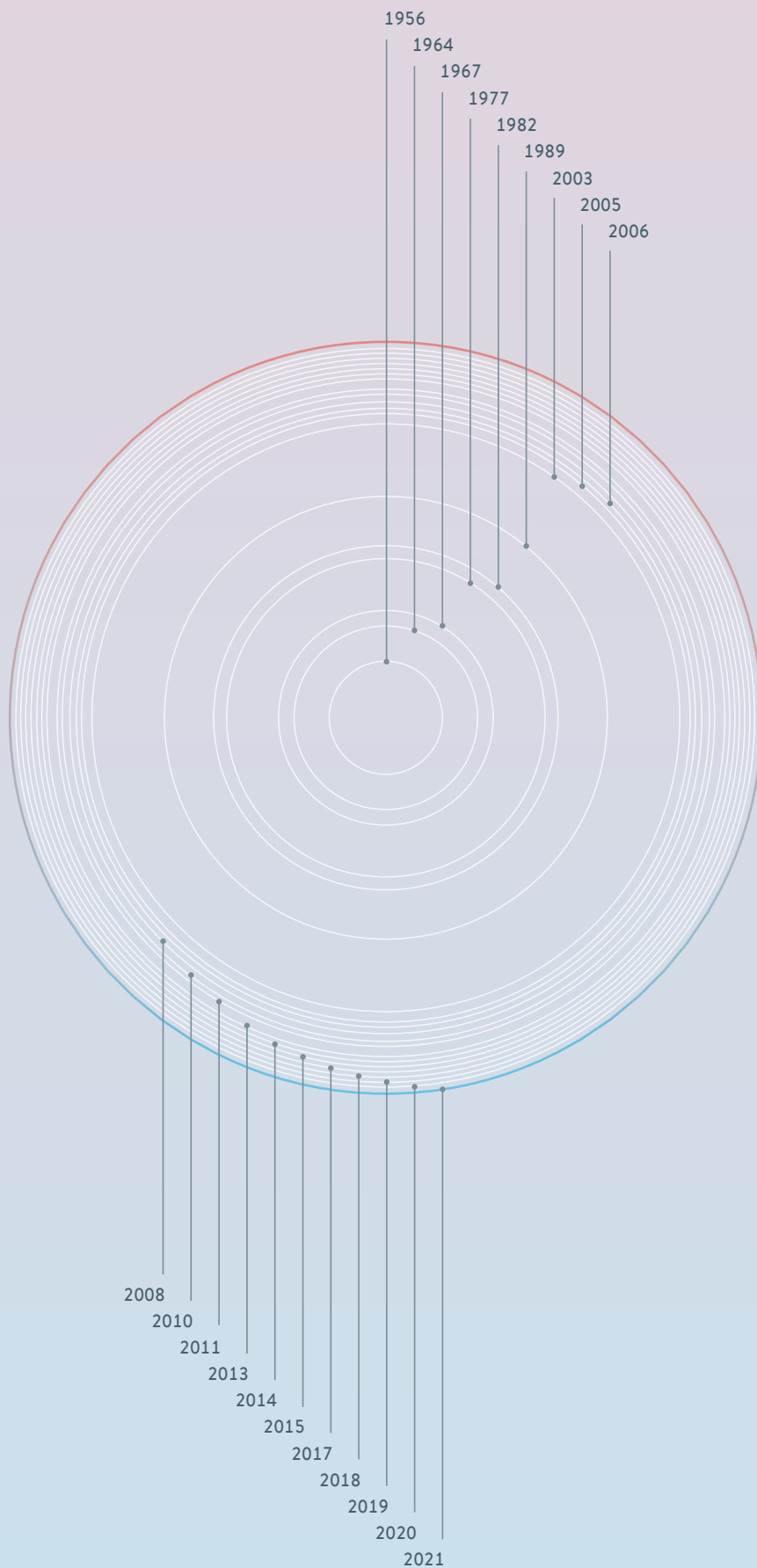

1956	The first year	Dr. Rudolf Wobser founds Messgerätewerk Lauda Dr. R. Wobser KG in the small town of Lauda in Baden.
1964	The first industrial systems	Since 1964, LAUDA has also been building industrial heating and cooling systems for technology centers and production.
1967	The first measuring instruments	Market launch of pioneering LAUDA innovations: such as the first tensiometer and first film weighing scales.
1977	Dr. Gerhard Wobser and Karlheinz Wobser take over the management	After their father's death, the two brothers take up the role of Managing Director and share responsibilities accordingly.
1982	The first thermostat with a microprocessor	LAUDA introduces the world's first thermostats featuring microprocessor technology and invents features such as proportional cooling and external control.
1989	The first year under today's company name	Renaming of company from Messgerätewerk Lauda Dr. R. Wobser KG to LAUDA DR. R. WOBSEK GMBH & CO. KG.
2003	Dr. Gunther Wobser appointed Managing Director	Karlheinz Wobser retires. Dr. Gunther Wobser, at LAUDA since 1997, becomes the new Managing Director.
2005	Subsidiary LAUDA France	First subsidiary LAUDA France is founded to support and advise customers and agencies on the market.
2006	50 years of LAUDA	LAUDA celebrates its 50th anniversary on March 1, 2006.
2008	Global expansion phase with new subsidiaries	LAUDA America Latina C.A., LAUDA China Co. Ltd. and LAUDA-Brinkmann, LP, USA, are founded.
2010	Dr. Gerhard Wobser resigns	His son, Dr. Gunther Wobser, takes over his duties.
2011	Acquisition of LAUDA Ultracool	LAUDA expands its product range with industrial circulation chillers by acquiring LAUDA Ultracool S.L.U. in Barcelona.
2013	New building	Opening of a new logistics center and production hall.
2014	Expansion LAUDA-Noah	LAUDA buys US company Noah Precision and expands the product range with thermo-electric thermostats.
2015	Independent company for measuring devices	The new subsidiary LAUDA Scientific takes over development, sales and service activities for LAUDA measuring.
2017	Progress with Peltier technology	An innovative thermo-electric circulation thermostat, the LAUDA LOOP, enables location-independent temperature control.
2018	New branding for LAUDA	LAUDA is introducing a confident new corporate design with a redesigned logo and new slogan.
2019	Aquisition of GFL	LAUDA acquires the traditional company GFL, thereby expanding its expertise in lab technology.
2020	New benchmarks in device design	LAUDA transitions all its product lines to a consistent and ultra-modern new design.
2021	Medical technology in focus	LAUDA is expanding its expertise in the medical market with the newly founded LAUDA Medical GmbH & Co. KG.

LAUDA

Applications according to sectors

RESEARCH AND DEVELOPMENT LABORATORIES



In research and development, temperature control is particularly important in the areas of sample preparation and quality assurance. As part of the sample preparation, a pre-tempering takes place in many cases. Many processes in quality assurance require the observance of a defined temperature or the targeted change of the temperature in a defined time.

Typical applications

- Sample preparation
- Quality assurance
- Research laboratory

AUTOMOTIVE



Temperature control in the automotive sector is mainly found in test benches and material tests. All components of the automobile are exposed to particularly high temperature fluctuations. Great importance is attached to component testing on special test benches. The simulation of environmental conditions such as high or low temperatures is an important part of material testing.

Typical applications

- Test bench applications
- Material testing

BIOTECHNOLOGY



In biotechnology, temperature control is essential to the quality of research and production results. Constant temperatures in the operation of bioreactors contribute significantly to the success of the products. As part of sample preparation, there are a variety of work steps that require reliable temperature control.

Typical applications

- Bioreactors
- Sample preparation

CHEMISTRY



In the chemical industry, there are many processes where temperature control plays an important role, including reactor temperature control and process engineering. At tempering processes in reactors, applications such as chemical reactions, syntheses, production of drug substances, polymerizations or crystallizations take place.

Typical applications

- Reactor temperature control
- Process engineering

PHARMACEUTICAL INDUSTRY



In the pharmaceutical industry, the temperature control processes range from research to production scale. To obtain high-quality reaction products, temperature control systems must reliably control the process sequence in an external reactor.

Typical applications

- Reactor temperature control
- Process engineering

SEMICONDUCTOR INDUSTRY



In the production of semiconductors and the testing of electronic components, there are numerous processes that must be exactly tempered. These include, for example, the organometallic chemical vapor phase deposition (MOCVD) in semiconductor coating as a precursor of LED production. Other typical temperature-dependent investigations in the semiconductor industry include stress tests for function and load testing, environmental simulations, and in-circuit tests of electronic assemblies.

Typical applications

- Process cooling
- Component testing

AEROSPACE

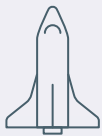

Temperature simulations and temperature-dependent material tests are an important component in the aerospace industry. Cyclic temperature stress tests ensure that a trouble-free usage of the components used is always ensured, even under extremely fluctuating external conditions in space.

Typical applications

- Material testing
- Temperature simulation

MEDICAL TECHNOLOGY



In medical technology, temperature control is found primarily in the laboratory for sample preparation and in medical devices such as imaging machines, medical lasers or devices used in pharmaceutical and medical laboratories.

Typical applications

- Medical laboratory
- Medical device

HYDROGEN



Hydrogen has a key role to play in managing the energy transition. Hydrogen is extremely important as environmentally friendly energy system, both for energy storage and for future mobility. In this respect, correct temperature control is an essential element in many applications, e.g. the cooling and temperature control of sustainable e-fuel processes for CO₂-neutral fuels.

Typical applications

- Refueling hydrogen vehicles
- Process cooling of electrolyzer applications
- Cooling with heat discharge in the compression process, pre-cooling of the hydrogen with chillers or energy-saving systems

MECHANICAL AND PLANT ENGINEERING

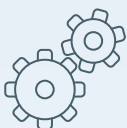

In mechanical engineering, even small deviations from the set temperature can compromise quality, reduce the service life of the machine and increase the risk of breakdown. Reproducible production processes on laser cutting machines or high-precision machine tools can only be ensured by constant temperature control.

Typical applications

- Laser cutting machines
- UV curing and UV drying
- Precision machine tools
- Digital printing machines

LAUDA Group

The essential facts

We are LAUDA – the world leader in precise temperatures. Our Constant temperature equipment and systems are at the heart of important applications, contributing to a better future. As a full-service provider we guarantee the optimum temperature in research, production and quality control. We are the trusted partner for electromobility, hydrogen, chemical, pharmaceutical/ biotech, semiconductor and medical industries. For over 65 years we have been inspiring our customers with our competent consulting and innovative solutions, anew every day – globally.

92.000.000

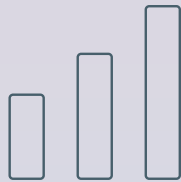

Revenue in euro

530



Employees

102

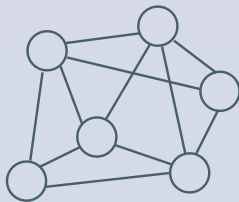

Number of representatives

135



Supported countries

5



Production sites

9



Distribution companies

40 %
Portfolio

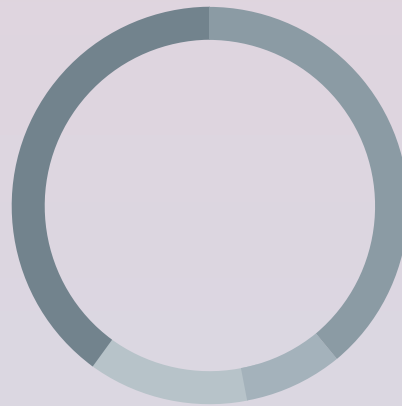

39 %
Customer-specific devices

13 %
Plant engineering

8 %
Service

Business units (Portion of overall turnover 2021)

PORTFOLIO

From water baths to high-performance process thermostats: LAUDA thermostats are characterized by their excellent handling, highly ergonomic design and intuitive operation and provide a working temperature range from -100 to 320°C .

PLANT ENGINEERING

Heating and cooling to the accuracy of a tenth degree in a temperature range from -150 to 550°C : with tailor-made systems for industrial applications according to modular engineering principles.

CUSTOMER-SPECIFIC DEVICES

Customer-specific advice with corresponding instrument selection and development of individual temperature control solutions for an optimum cost-benefit ratio with decades of successful partnerships.

SERVICE

High product quality and comprehensive professional services form an inseparable unit at LAUDA. Regular care, service and maintenance by highly qualified LAUDA service specialists ensures the high performance of your LAUDA devices.



LAUDA WINS: WITH PRODUCTS, SAFETY AND SERVICE – AND PEACE OF MIND.



Large selection

Whether it's for routine tasks, professional and economical temperature control, high cooling outputs and high cooling rates or lightning-fast temperature changes – LAUDA has the right solution for almost every requirement.



Exemplary safety concepts

All products meet the most stringent safety requirements and provide peace of mind in every application, thanks to the intelligent technologies and sophisticated safety concepts.



Easy handling

All LAUDA devices are characterized by excellent handling, a highly ergonomic design and intuitive operation. They also offer maximum user convenience and future-oriented software.



First-class advice – internationally

The LAUDA team provides friendly, fair, and expert advice. LAUDA application experts help customers worldwide to configure application-optimized systems.



Proverbial quality

For more than 65 years, LAUDA has been developing, designing and producing high-quality constant temperature equipment to the highest standards in quality and safety – confirming time and again the durability and longevity that LAUDA has become known for.



Reliable service

Robust LAUDA devices are known for their durability. If you still need additional support, we will not let you down: with quick access to comprehensive services – for greater flexibility and cost-efficiency.

LAUDA

Overview



You will find information about system engineering at www.lauda.de

DIGITAL PRODUCTS

LAUDA.LIVE P.16

WATER BATHS

Hydro P.20

HEATING THERMOSTATS

Alpha P.36

ECO P.38

PRO P.40

Proline Bridge thermostats P.42

Proline Clear-view thermostats P.44

COOLING THERMOSTATS

Alpha P.60

ECO P.62

PRO P.64

Proline Kryomats P.66

CIRCULATION AND PROCESS THERMOSTATS

LOOP P.84

PRO P.86

Integral T P.88

Integral XT P.90

Integral P P.92

Variocool P.94

Semistat P.96

CIRCULATION CHILLERS

Microcool P.116



Ultracool P.118

CALIBRATION THERMOSTATS

ECO P.132

Proline P.134

DEEP-FREEZERS

Versafreeze P.142

SHAKERS

Varioshake P.148

STILLS

Puridest P.154

ACCESSORIES

Heat transfer liquids P.158

Further accessories P.160

LAUDA DIGITAL PRODUCTS



Specific application examples

- Location-independent monitoring and configuration
- Machine-aided analysis and optimization
- Remote maintenance and parameterization via the LAUDA Helpdesk
- Administration of constant temperature equipment and maintenance management

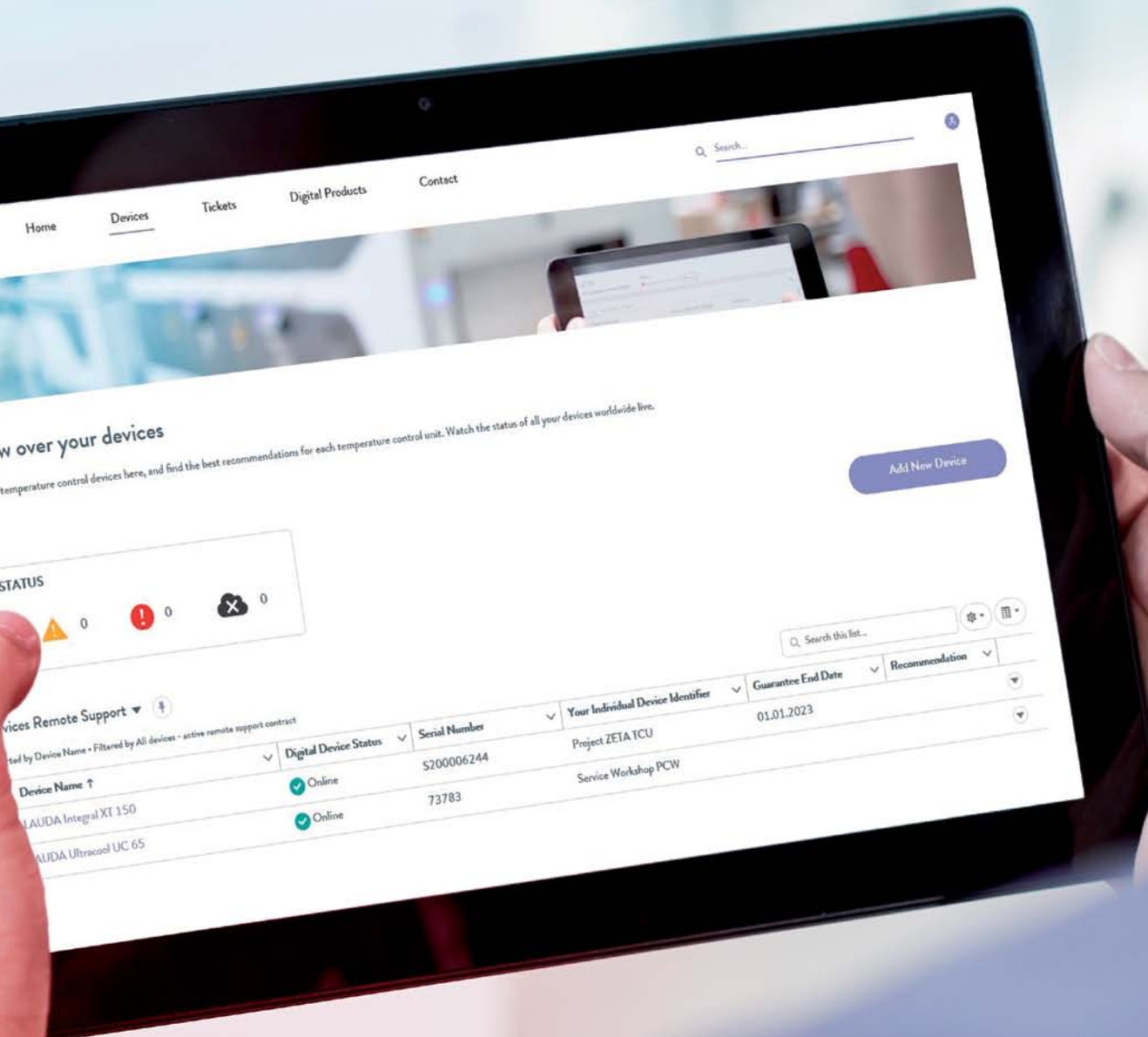

Home

Devices

Tickets

Digital Products

Contact

Search...

Control over your devices

Register your temperature control devices here, and find the best recommendations for each temperature control unit. Watch the status of all your devices worldwide live.

Add New Device

STATUS

0
 0
 0

Search this list...

Devices Remote Support

Sorted by Device Name • Filtered by All devices - active remote support contract

Device Name ↑	Digital Device Status	Serial Number	Your Individual Device Identifier	Guarantee End Date	Recommendation
LAUDA Integral XT 150	Online	S200006244	Project ZETA TCU	01.01.2023	
LAUDA Ultracool UC 65	Online	73783	Service Workshop PCW		

Digital products

Water baths

Heating thermostats

Cooling thermostats

Circulation and process thermostats

Circulation chillers

Calibration thermostats

Deep-freezers

Shakers

Stills

Accessories

LAUDA.LIVE

Ready for the Future

With future-oriented connectivity, seamless integration into existing processes and the possibilities of LAUDA.LIVE, LAUDA is offering a digital solution that will make your applications safer and more efficient. LAUDA.LIVE and its application areas are constantly being further developed in order to realize the vision of digitalizing temperature control technology.

Check it out now at:
www.lauda.live

The screenshot shows the LAUDA.LIVE web interface. At the top, there is a navigation bar with 'Home', 'Devices', 'Tickets', 'Digital Products', and 'Contact'. Below the navigation bar is a header image of a person holding a tablet. The main content area is titled 'Overview over your devices' and includes a 'DEVICE STATUS' section with icons for online (2), warning (0), error (0), and offline (0) devices. Below this is a 'Your Devices Remote Support' section with a table of devices.

Device Name	Digital Device Status	Serial Number	Your Individual Device Identifier	Guarantee End Date	Recommendation
1 LAUDA Integral XT 150	Online	S200006244	Project ZETA TCU	01.01.2023	
2 LAUDA Ultrasonic UIC 65	Online	73783	Service Workshop PCW		

Modern device management and high-performance analytical tools

The digital products from LAUDA.LIVE

Fleet Management (free of charge)

- **Asset Management:** Manage your fleet of devices and monitor their condition
- **Maintenance Log:** Keep track of your maintenance schedule and record important information
- **Warranty Management:** Create transparency for the warranty status of your devices
- **Ticket System:** Create, monitor and look up historical support tickets

Remote Support

- **24/5 Remote Support:** Our service hotline in five service centers helps you 24 hours a day
- **Communication:** Support provided by German, English and Chinese native speakers
- **Cost Minimization:** Reduction of costs for service calls by analyzing the causes of errors before personnel are needed on site
- **Updates:** Remote firmware and function updates save costs and increase system performance

Monitoring & Analytics

- **Global Monitoring:** Remote monitoring and control of all devices from home, while traveling or in the factory, no matter where you are located
- **Data Storage:** Secure data logging enables graphical analysis of device data and export for external documentation, analysis and test reports
- **Alerting:** Flexibly configurable notifications of alarms or limit violations via text message or e-mail or in the cloud
- **Analytics:** KPIs (Key Performance Indicators) support benchmarking and device optimization

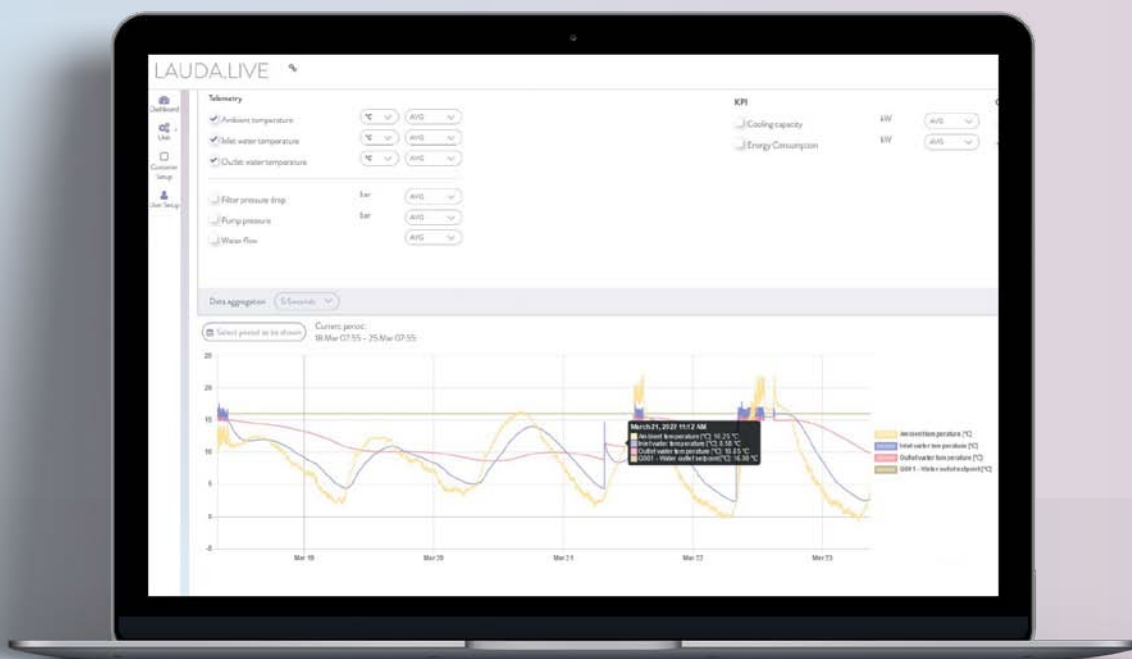

LAUDA.LIVE

LAUDA.LIVE is the start of a series of new digital products from LAUDA. All LAUDA temperature control and laboratory solutions turn into fully networked and intelligent IIoT (Industrial Internet of Things) devices. LAUDA.LIVE offers extensive asset management functions, even for devices without IIoT connectivity, intelligent analysis and monitoring tools, as well as sophisticated control and remote maintenance functions which maximize the operating time, reliability and performance of all LAUDA devices.

LAUDA WATER BATHS

Specific application examples

- Preparation of cellular, biological and medical samples
- Incubation of microbiological tests
- Preparation of environmental samples
- Defrosting of samples
- Conducting of chemical reactions



Water baths

Heating thermostats

Cooling thermostats

Circulation and process thermostats

Circulation chillers

Calibration thermostats

Deep-freezers

Shakers

Stills

Accessories

LAUDA Hydro water baths

from 25 to 100 °C

25 °C  100 °C

Reliable and universal water baths

LAUDA offers a significantly expanded range of laboratory technology with six water baths and two water baths with a circulating function. The LAUDA Hydro water baths with a high-quality stainless steel interior provide the right bath depth and opening for every application with bath volumes from 4 to 41 liters. All water baths have a temperature range of up to 100 °C with a temperature stability of ± 0.1 K, which also permits applications in the boiling temperature range. A TFT display ensures intuitive operation with a temperature display in °C and °F.



High-quality, welded stainless steel bath interior, equipped with a sieve plate as standard



Large, high-contrast TFT display with menu-guided controls

HEATING PERFORMANCE Heat transfer liquid: Water, bath closed

Bath temperature °C

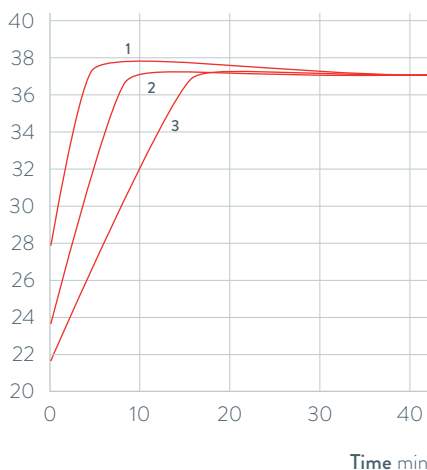

1 H 8
2 H 8 A
3 H 22

Important functions

- Three user-specific timer functions
- Direct temperature control for rapid heating
- Visual and acoustic alarm in case of low level, over-/under-temperature as well as sensor break
- Lid design prevents condensation from dripping back on samples

Standard equipment

Double-walled, heat-insulating stainless steel lid and drain tap

Additional accessories

Adjustable water level controller, rack for test tubes of different diameters and baby milk bottles, Flat stainless-steel cover with ring inserts (6 openings/diameter 91 mm, suitable for H 16, H 16 A and H 22)

All technical data and power supply variants can be found in the »Technical data« section.

More at www.lauda.de/de/1780



LAUDA Hydro water baths

The LAUDA Hydro water baths are optimally equipped for every laboratory application and ensure homogeneous temperature distribution without local overheating. LAUDA Hydro water baths with precision temperature distribution and optional circulation (H 8 A and H 16 A) are designed for the requirements of biological, medical and biochemical laboratories.



LAUDA Hydro shaking water baths

from 10 to 99.9 °C



Reliable, maintenance-free shaking water baths

The shaking water baths of the LAUDA Hydro series can be used for a variety of tasks in the laboratory depending on requirements. The device type H 20 SOW creates a circular motion for the sample whereas the types H 20 S and H 20 SW are designed for a linear, oscillating shaking movement.

The built-in speed controller of the LAUDA Hydro shaking water baths enables a load-independent, infinitely variable shaking movement with a soft start. The two shaking water baths H 20 SW and H 20 SOW are equipped with a cooling coil as standard. The temperature range of the shaking water baths can be extended down to +10 °C by connecting them to commercially available circulation chillers, such as the LAUDA Microcool.



Drain valve on the back of the device



Operation left: Temperature adjustment with LED display, right: Speed adjustment of the shaking unit



Bath interior completely made of stainless steel: shaking basket, heating element, cover frame, lid

Important functions

- Digital temperature adjustment and indication via LED display
- Load-independent, continuously variable shaking device with a gentle start-up
- Electronic function monitoring of the temperature controller, two independent under and overtemperature protection fuses
- Bath body, cover frame with condensation channel, shaking basket and heater made of stainless steel

Additional accessories

Adjustable water level controller, perforated shaking tray for fastening of clips for Erlenmeyer flasks and various racks for test tubes and Falcon tubes

All technical data and power supply variants can be found in the »Technical data« section.

More at www.lauda.de/de/1781



LAUDA Hydro shaking water baths

Shaking water baths in the LAUDA Hydro device line move samples in the laboratory with a linear or orbital shaking movement, depending on the model. LAUDA Hydro shaking water baths are reliable companions for continuous operation in daily laboratory work.



LAUDA Hydro vaporization water baths

from 25 to 100 °C

25 °C  100 °C

High-performance, robust vaporization baths

The special baths for gentle vaporization work from columns, Erlenmeyer flasks or beakers are suitable for unattended continuous operation in the laboratory, thanks to water level controllers and low-level protection. The LAUDA Hydro vaporization water baths are available in five models, all equipped with a removable hole cover with a multi-piece ring set, made of heat-resistant plastic.



H 6 V vaporization water bath with four openings and support rods as standard for secure fastening of vaporization vessels



H 11 V with stainless steel external housing, specially designed for use in fume hoods

Important functions

- Temperature setting via a rotary knob with temperature scale
- Different number of openings
- Removable hole cover consisting of a multi-piece ring set
- H 11 V and H 19 V with a stainless steel external housing, especially for digestories for fume hoods
- Adjustable water level controller as standard

Additional accessories

Stainless steel support rod for H 5 V

All technical data and power supply variants can be found in the »Technical data« section.

More at www.lauda.de/de/1782



LAUDA Hydro vaporization water baths

LAUDA Hydro vaporization baths operate in a temperature range from 25 to 100 °C. The opening diameter of the water bath can be variably changed in approx. 20 mm increments by means of the multi-piece ring set. The models H 11 V and H 19 V are specially designed for protected working use in fume hoods. The housings are made of stainless steel to allow evaporation work with chemically aggressive chemical media.



LAUDA Hydro tissue float baths

from 25 to 80 °C

25°C 80°C

User-friendly and reliable tissue float baths

Tissue float baths are used in histological, chemical, clinical and bacteriological labs for the stretching and drying of cut tissue samples. The precise temperature control of the LAUDA Hydro tissue float baths ensures evenly stretched samples that are clearly visible inside the bath and guarantees gentle drying of the stretched samples on the heated edge.



Adjustable bath temperature with heating activity display



Temperature display via thermometer

Important functions

- Temperature setting via a rotary knob with temperature scale
- Temperature display via reference thermometer on the edge of the bath
- Bath interior in black anodized aluminum

Additional accessories

Dust protection cover

All technical data and power supply variants can be found in the »Technical data« section.

More at www.lauda.de/de/1783

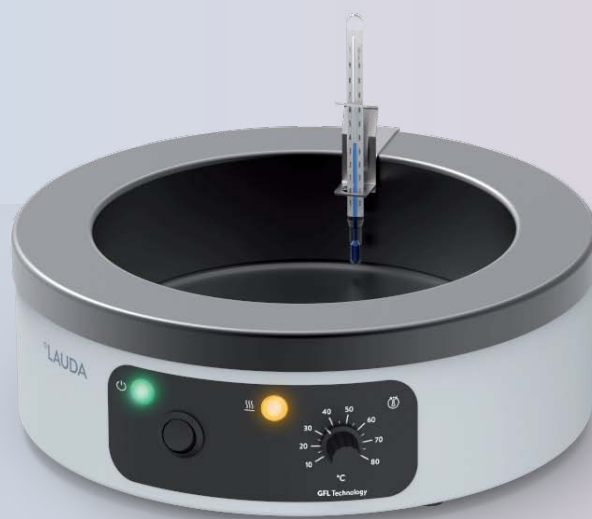

LAUDA Hydro paraffin stretching baths

The LAUDA Hydro tissue float baths function within a temperature range of 25 to 80 °C with a temperature stability of ± 0.5 K. The bath body is made of black anodized aluminum. The low bath height enables work to be carried out safely and easily.



LAUDA Water baths

Device type overview

LAUDA Hydro / Page 20

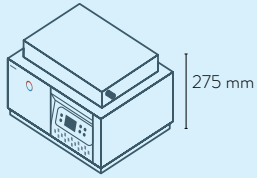

H 4

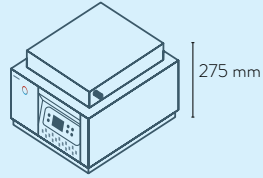

H 8

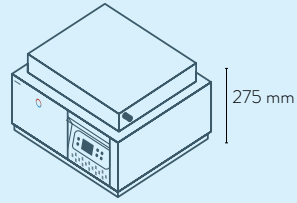

H 16

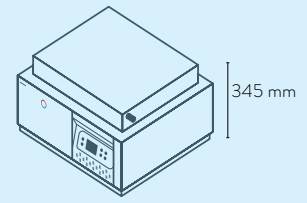

H 22

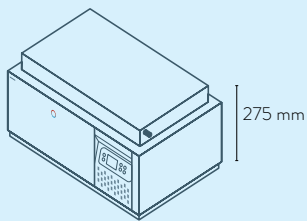

H 24

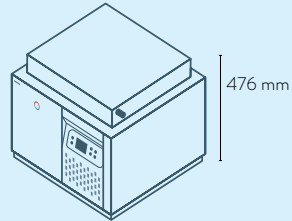

H 41

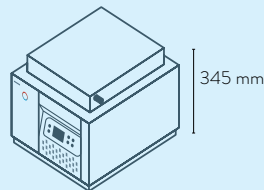

H 8 A

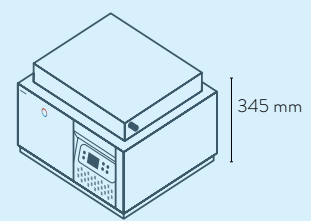

H 16 A

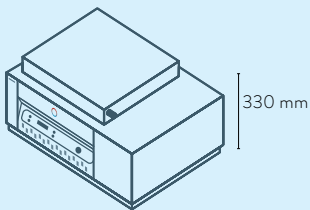

H 20 S
H 20 SW

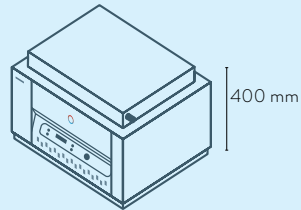

H 20 SOW

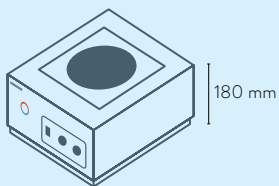

H 5 V

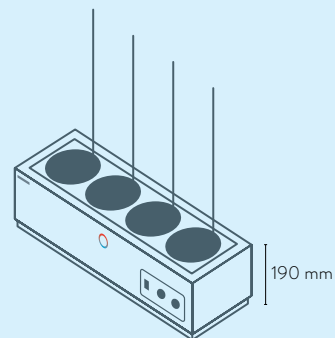

H 6 V

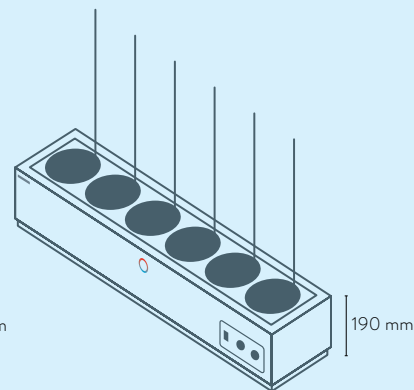

H 9 V

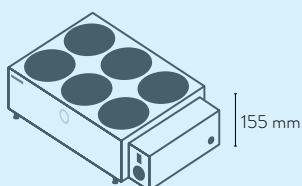

H 11 V

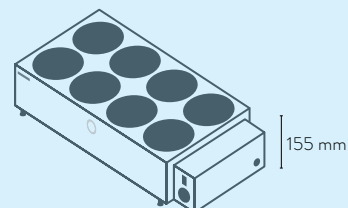

H 19 V

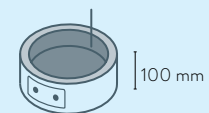

H 2 P

LAUDA Water baths

Technical data according to DIN 12876 standard

Device type*	Working temperature range °C	Working temperature range with water cooling °C	Temperature stability ±K	Safety fittings	Heater power max. kW	Shaking amplitude mm	Shaking frequency rpm	Movement type*	Bath volume min. L	Bath volume max. L	Number of bath openings	Bath opening (W x D) mm
LAUDA Hydro / Page 20												
H 4	25 ... 100	-	0.10	I, NFL	0.5	-	-	-	1.9	3.5	1	245×100
H 8	25 ... 100	-	0.10	I, NFL	1.0	-	-	-	3.8	7.0	1	245×200
H 16	25 ... 100	-	0.10	I, NFL	1.5	-	-	-	7.5	13.9	1	400×245
H 22	25 ... 100	-	0.10	I, NFL	1.5	-	-	-	7.5	20.3	1	400×245
H 24	25 ... 100	-	0.10	I, NFL	1.5	-	-	-	11.3	20.9	1	600×245
H 41	25 ... 100	-	0.10	I, NFL	1.5	-	-	-	9.3	37.9	1	410×296
H 8 A	25 ... 100	-	0.10	I, NFL	1.0	-	-	-	3.8	7.0	1	245×200
H 16 A	25 ... 100	-	0.10	I, NFL	1.5	-	-	-	7.5	13.9	1	400×245
H 20 S	25 ... 100	-	0.10	I, NFL	1.5	22	10 ... 250	B	9.0	24.4	1	450×300
H 20 SW	25 ... 100	10 ... 100	0.10	I, NFL	1.5	22	10 ... 250	B	9.0	24.4	1	450×300
H 20 SOW	25 ... 80	10 ... 80	0.10	I, NFL	1.5	14	10 ... 250	O	8.5	23.1	1	450×300
H 5 V	25 ... 100	-	3.00	I, NFL	1.0	-	-	-	-	5.0	1	Ø 192
H 6 V	25 ... 100	-	3.00	I, NFL	1.0	-	-	-	-	5.3	4	Ø 131
H 9 V	25 ... 100	-	3.00	I, NFL	1.5	-	-	-	-	8.0	6	Ø 131
H 11 V	25 ... 100	-	3.00	I, NFL	1.5	-	-	-	-	10.5	6	Ø 91
H 19 V	25 ... 100	-	3.00	I, NFL	1.5	-	-	-	-	18.4	8	Ø 111
H 2 P	25 ... 80	-	0.50	I, NFL	0.3	-	-	-	-	1.6	1	Ø 200

*A = Agitation (water bath with circulating system) O = Orbital (circular motion) B = Bidirectional (linear or back and forth motion)

Bath depth mm	Usable depth mm	Height top of bath mm	Dimensions (W x D x H) mm	Weight kg	Power supply V; Hz	Loading max. kW	Part Number	Device type
165	115	218	340×290×275	7	230 V; 50/60 Hz	0.5	L002900	H 4
165	115	218	340×395×275	10	230 V; 50/60 Hz	1,0	L002901	H 8
165	115	218	500×440×275	14	230 V; 50/60 Hz	1.5	L002902	H 16
225	180	278	500×440×345	16	230 V; 50/60 Hz	1.5	L002903	H 22
165	115	218	700×440×275	18	230 V; 50/60 Hz	1.5	L002904	H 24
335	285	388	510×490×476	22	230 V; 50/60 Hz	1.5	L002905	H 41
165	115	218	340×395×345	12	230 V; 50/60 Hz	1.0	L002906	H 8 A
165	115	218	500×440×345	16	230 V; 50/60 Hz	1.5	L002907	H 16 A
185	160	277	715×520×330	28	230 V; 50/60 Hz	1.5	L002908	H 20 S
185	160	277	715×520×330	29	230 V; 50/60 Hz	1.5	L002909	H 20 SW
185	160	347	635×505×400	35	230 V; 50/60 Hz	1.5	L002910	H 20 SOW
-	120	180	342×400×180	9	230 V; 50/60 Hz	1.0	L003066	H 5 V
-	90	190	1010×270×192	13	230 V; 50/60 Hz	1.0	L003067	H 6 V
-	90	190	1010×270×192	19	230 V; 50/60 Hz	1.5	L003068	H 9 V
-	100	155	450×300×155	6	230 V; 50/60 Hz	1.5	L003069	H 11 V
-	100	155	690×300×155	8	230 V; 50/60 Hz	1.5	L003070	H 19 V
60	60	100	280×280×100	2	230 V; 50/60 Hz	0.3	L003071	H 2 P

LAUDA Water baths

Power supply variants

Device type	Power supply V; Hz	Loading max. kW	Plug code*	Part Number	Device type	Power supply V; Hz	Loading max. kW	Plug code*	Part Number
LAUDA Hydro / Page 20									
H 4	100 V; 50/60 Hz	0.5	14	L002922	H 5 V	100 V; 50/60 Hz	1.0	14	L003078
H 4	115 V; 60 Hz	0.5	14	L002911	H 5 V	115 V; 60 Hz	1.0	14	L003072
H 8	100 V; 50/60 Hz	1.0	14	L002923	H 6 V	100 V; 50/60 Hz	1.0	14	L003079
H 8	115 V; 60 Hz	1.0	14	L002912	H 6 V	115 V; 60 Hz	1.0	14	L003073
H 16	100 V; 50/60 Hz	1.5	14	L002924	H 9 V	100 V; 50/60 Hz	1.5	14	L003080
H 16	115 V; 60 Hz	1.5	14	L002913	H 9 V	115 V; 60 Hz	1.5	14	L003074
H 22	100 V; 50/60 Hz	1.5	14	L002925	H 11 V	100 V; 50/60 Hz	1.5	14	L003081
H 22	115 V; 60 Hz	1.5	14	L002914	H 11 V	115 V; 60 Hz	1.5	14	L003075
H 24	100 V; 50/60 Hz	1.5	14	L002926	H 19 V	100 V; 50/60 Hz	1.5	14	L003082
H 24	115 V; 60 Hz	1.5	14	L002915	H 19 V	115 V; 60 Hz	1.5	14	L003076
H 41	100 V; 50/60 Hz	1.5	14	L002927	H 2 P	100 V; 50/60 Hz	0.3	14	L003083
H 41	115 V; 60 Hz	1.5	14	L002916	H 2 P	115 V; 60 Hz	0.3	14	L003077
H 8 A	100 V; 50/60 Hz	1.0	14	L002928					
H 8 A	115 V; 60 Hz	1.0	14	L002917					
H 16 A	100 V; 50/60 Hz	1.5	14	L002929					
H 16 A	115 V; 60 Hz	1.5	14	L002918					
H 20 S	100 V; 50/60 Hz	1.5	14	L002930					
H 20 S	115 V; 60 Hz	1.5	14	L002919					
H 20 SW	100 V; 50/60 Hz	1.5	14	L002931					
H 20 SW	115 V; 60 Hz	1.5	14	L002920					
H 20 SOW	100 V; 50/60 Hz	1.5	14	L002932					
H 20 SOW	115 V; 60 Hz	1.5	14	L002921					

*All data for the plug codes can be found on page 162.

LAUDA

HEATING THERMOSTATS



Specific application examples

- Sample preparation for chemical and pharmaceutical analysis
- Medical serology
- Biotechnology
- Material testing



Heating thermostats

Cooling thermostats

Circulation and process thermostats

Circulation chillers

Calibration thermostats

Deep-freezers

Shakers

Stills

Accessories

LAUDA Alpha

Heating thermostats from 25 to 100 °C for cost-effective temperature control thermostating in the lab

25°C ————— 100°C

Cost-effective thermostats with reliable technology incorporated into a modern design

LAUDA Alpha is the most cost-effective choice when it comes to premium-quality LAUDA thermostats. These reliable and user-friendly thermostats, with features optimized for essential use, can be operated with non-flammable liquids and are suitable for both internal and external temperature control tasks.



Simple and intuitive menu navigation with three-button operation using a large, clearly legible LED display



Screw clamp allows easy change to different bath vessels with a maximum wall thickness of 30 mm

HEATING PERFORMANCE Water, bath closed

Bath temperature °C

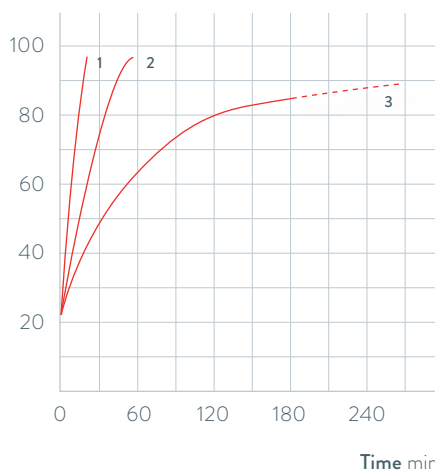

- 1 A6
- 2 A12
- 3 A24

Important functions

- Deep-drawn stainless steel bath vessels
- Integrated timer function allows automatic device shutdown (Standby)
- Low-level and overtemperature protection for operation with non-flammable liquids

Included accessories

Screw clamp, attachment nozzle in two sizes

Further accessories

Pump circulation set, cooling coil, bath cover set

All technical data and power supply variants can be found in the ›Technical data‹ section.

More at www.lauda.de/1724



LAUDA Alpha

Heating thermostats A6, A12 and A24 work in the temperature range between 25 and 100 °C. Cooling coil, pump circulation set and bath cover set are available as accessories for all thermostats.



LAUDA ECO

Heating thermostats from 20 to 200 °C
for economic temperature control in the lab



Economic and high-performance temperature control

The ECO thermostats are available in Silver (LCD) or Gold (color TFT display) models with a large number of interface modules as accessories. The circulation pump can be adjusted to six levels. The ECO heating thermostat line encompasses transparent baths up to 100 °C as well as immersion thermostats and heating thermostats with stainless steel baths up to 200 °C.



Plain text menu navigation on a monochrome LCD (Silver) or color TFT display (Gold) for easy operation



Standard-issue cooling coil included with all heating thermostats

HEATING PERFORMANCE Heat transfer liquid: Therm 250, bath closed

Bath temperature °C

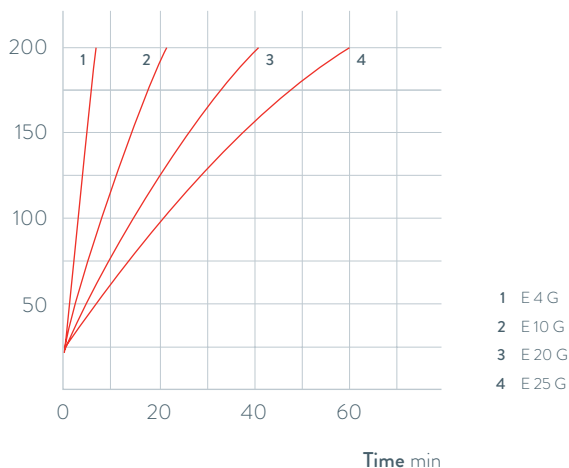

- 1 E 4 G
- 2 E 10 G
- 3 E 20 G
- 4 E 25 G

Important functions

- Integrated programmer for automating temperature profiles
- Adjustment of flow rate switch for internal/external circulation, can be controlled from exterior during operation
- Can be upgraded with Pt100/LiBus module for external control
- Individually limitable working temperature range, as well as a separate setting for overtemperature protection

Included accessories

Cooling coil, bath cover and pump connections (with E 4)

Further accessories

Tubing, bath cover, pump connection set, interface modules (P. 47)

All technical data and power supply variants can be found in the ›Technical data‹ section.

More at www.lauda.de/1726



LAUDA ECO

Bath thermostats come equipped with a cooling coil as standard. The E4 is also equipped with a bath cover and pump connections for external application connections. A drain tap on the back side of the device makes changing the heat transfer liquid in the stainless steel baths easy and safe.



LAUDA PRO

Heating bath thermostats from 30 to 250 °C
for professional temperature control



Flexible operation, outstanding performance characteristics

LAUDA PRO is the cutting-edge product line with an outstanding overall concept: The innovative Base or Command Touch operating units can be detached and used as a remote control. Heating bath thermostats come equipped with a cooling coil as standard.



Low device height and 360° accessibility of the bath thanks to detachable remote control



Ethernet and USB interface and Pt100 connection as standard

HEATING PERFORMANCE Heat transfer liquid: Therm 250, bath closed

Bath temperature °C

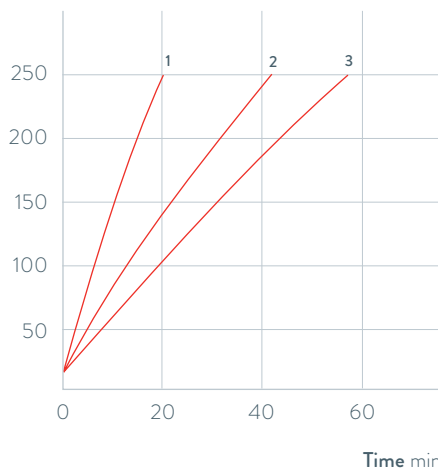

- 1 P10 C
- 2 P20 C
- 3 P30 C

Important functions

- Draining tap on the front of the device
- Operated via Base operating unit with OLED display or Command Touch with color touch screen
- Stainless steel bath vessels (insulated with handles)
- Internal LAUDA Vario Pump with 8 selectable output levels
- Ethernet and USB interface and Pt100 connection as standard

Included accessories

Bath cover, tubing nipples with screw caps for the cooling coil

Further accessories

External pump, interface modules

All technical data and power supply variants can be found in the »Technical data« section.

More at www.lauda.de/1728



LAUDA PRO

The LAUDA PRO heating baths P 10, P 20 and P 30, with volumes of 10, 20 and 30 liters, operate up to a maximum temperature of 250 °C. Their excellent temperature stability (± 0.01 K) make them perfect for internal bath applications. The detachable operating unit, including mount, allows for considerable reduction in the height of the device.



LAUDA Proline bridge thermostats

Bridge thermostats 30 to 300 °C
for temperature control of any bath

30°C  300°C

Intuitive operation with broad temperature range

The LAUDA Proline bridge thermostats with vario flex pump are great for temperature control of any bath vessel. The PB models have a pressure/suction pump, but the PBD models are equipped with stronger pressure pumps. They enable temperature control on deeper baths of up to 320 mm. A telescoping rod for baths with a width of 310 to 550 mm, an ergonomic handle and side pump connections are also available.

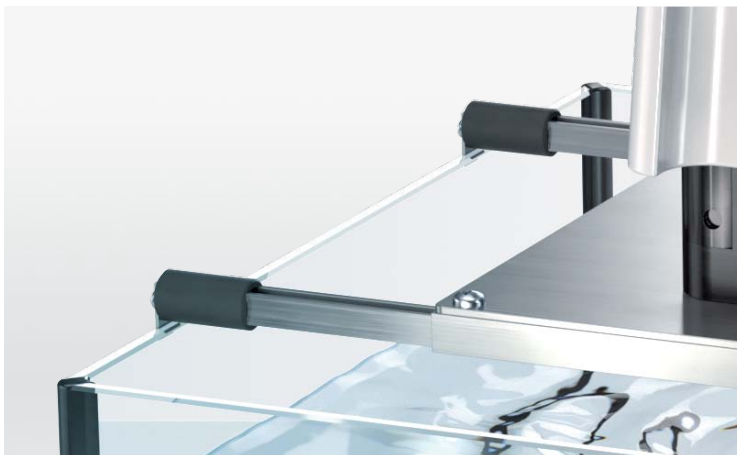

Extendable telescoping rods for placement on baths with widths of 310 to 550 mm



Removable Command remote control unit for easy and intuitive operation

PUMP CHARACTERISTICS for PBD and PBD C, Liquid: Water

Pressure bar

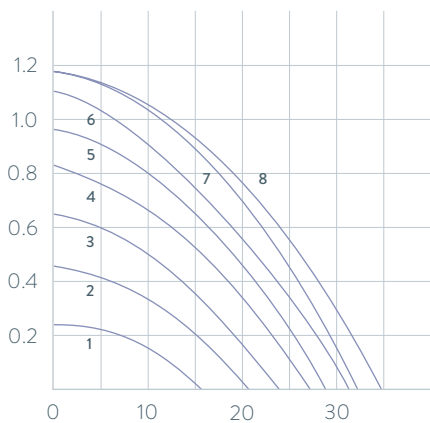

- 1 Step 1
- 2 Step 2
- 3 Step 3
- 4 Step 4
- 5 Step 5
- 6 Step 6
- 7 Step 7
- 8 Step 8

Pump flow L/min

Important functions

- Programmer with 150 temperature/time segments and graphical temperature display with Command control unit
- PowerAdapt system for optimally adapted max. heating output without influencing the mains power supply
- Low-level protection and adjustable overtemperature protection with acoustic alarm. Float for identifying low or high level

Included accessories

Tubing nipples for pump connection, telescoping rod

Further accessories

Automatic filling device, bath vessels, interface modules

All technical data and power supply variants can be found in the »Technical data« section.

More at www.lauda.de/1730



LAUDA Proline bridge thermostats

LAUDA Proline bridge thermostats are available with two different control units. The master version is designed for all applications in which the parameters are not changed very often. The removable Command operating unit offers a graphic LCD screen for high operating convenience and an additional programmer.



LAUDA Proline clear-view thermostats

Heating clear-view thermostats from 30 to 230 °C
in research, application technology and production

30°C  230°C

A clear view of the object at all times

LAUDA Proline clear-view thermostats are optimized for direct observation of objects. They are ideal for use with the fully automatic LAUDA viscometer PVS or iVisc, since the temporal and spacial temperature stability necessary for precise determination of viscosity is guaranteed across the whole temperature range. Furthermore, the two-chamber principle ensures a constant liquid level in the measuring chamber at all times, regardless of the fluid volume and temperature. The PVL models with five layers of insulated glass are suitable for low temperature measurements down to -40 or -60 °C when a cooling thermostat is connected.



Insulated glass makes it possible to observe samples, even at very low temperatures



Removable Command remote control unit for easy and intuitive operation

HEATING PERFORMANCE Heat transfer liquid: Therm 250, bath closed

Bath temperature °C

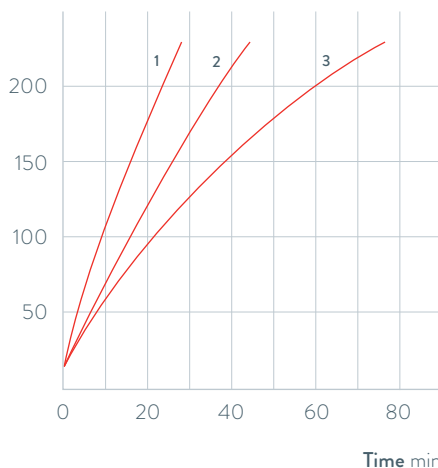

- 1 PV 15 (up to 230 °C)
PVL 15 (up to 100 °C)
- 2 PV 24 (up to 230 °C)
PVL 24 (up to 100 °C)
- 3 PV 36

Important functions

- Programmer with 150 temperature/time segments and graphical temperature display with Command control unit
- LAUDA Vario Flex pump (pressure pump) with eight selectable output levels
- Cooling coil fitted as standard allows connection of an additional cooler

Included accessories

Tubing nipples for pump connection and cooling coil

Further accessories

Solenoid valve for cooling water, additional cooler, interface modules

All technical data and power supply variants can be found in the »Technical data« section.

More at www.lauda.de/1732



LAUDA Proline clear-view thermostats

LAUDA Proline clear-view thermostats are available with two different control units. The master version is designed for all applications in which the parameters are not changed very often. The removable Command operating unit incorporates a graphic LCD screen for high operating convenience and also a programmer.



LAUDA Heating thermostats

Device type overview

LAUDA Alpha / Page 36

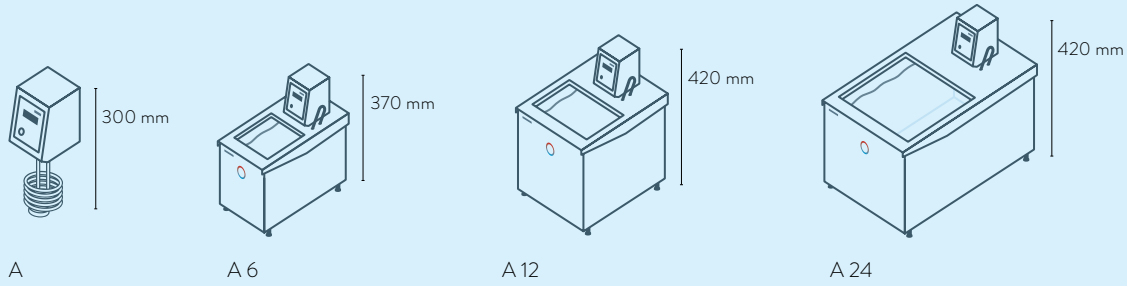

LAUDA ECO / Page 38

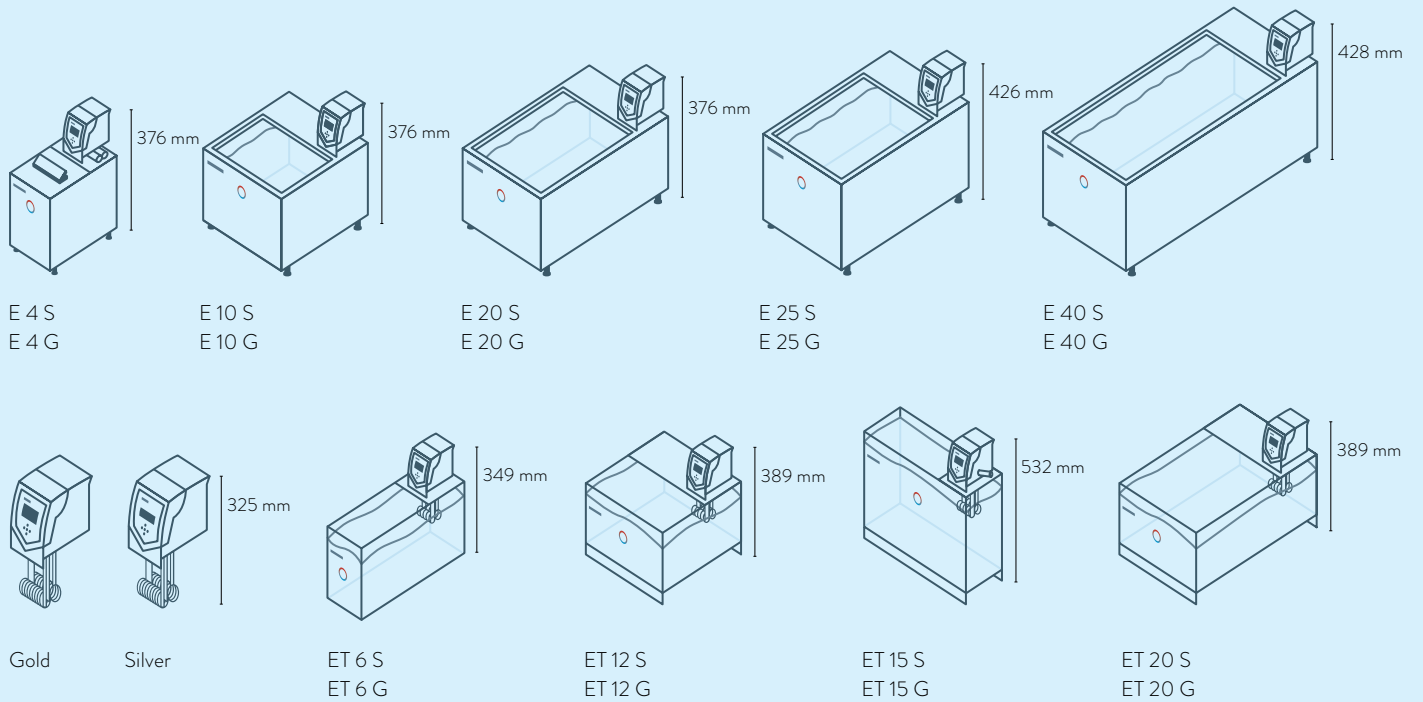

LAUDA PRO / Page 40

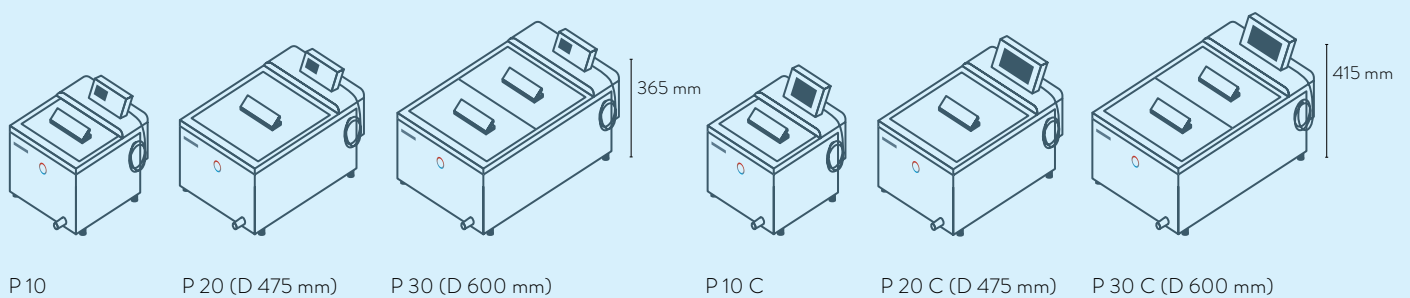

LAUDA Heating thermostats

Interfaces

	Pt 100 (1)	Pt 100 (2)	USB	Ethernet	RS 232 / 485	Analog	Namur contact	D-Sub contact	PROFIBUS	EtherCAT M8	EtherCAT RJ 45	Number of module slots, large	Number of module slots, small
LAUDA Alpha / Page 36	-	-	-	-	-	-	-	-	-	-	-	-	-
LAUDA ECO / Page 38	Z	-	S	Z	Z	Z	Z	Z	Z	Z	Z	1	1
LAUDA PRO / Page 40	S	-	S	S	Z	Z	Z	Z	Z	Z	Z	1	-
LAUDA Proline Master	S	-	-	Z	Z	Z	Z	Z	Z	Z	Z	2	-
LAUDA Proline Command	S	-	-	Z	S	Z	Z	Z	Z	Z	Z	2	-

S = Series standard

Z = Available as an accessory



LRZ 912
Analog module

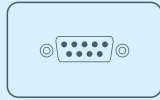

LRZ 913
RS 232/485 interface

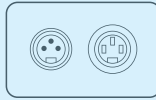

LRZ 914
Contact module with single input and single output (NAMUR)

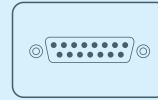

LRZ 915
Contact module with 3 inputs and 3 outputs

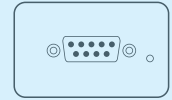

LRZ 917
Profibus module



LRZ 918
Pt100/Li bus module, small cover



LRZ 921
Ethernet module

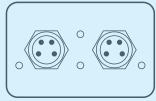

LRZ 922
EtherCAT module with M8 connection

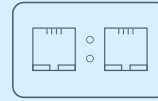

LRZ 923
EtherCAT module with RJ45 connection



LRZ 925
External Pt100/LiBus-module, large cover

LAUDA Proline bridge thermostat / Page 42

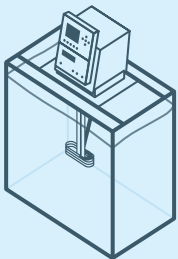

PB C
PBD C

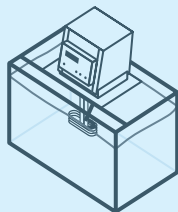

PB
PBD

LAUDA Proline clear-view thermostat / Page 44

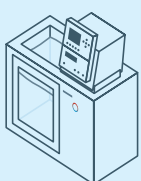

PV 15 C
PVL 15 C

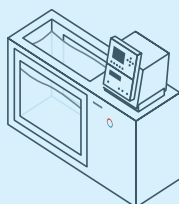

PV 24 C
PVL 24 C

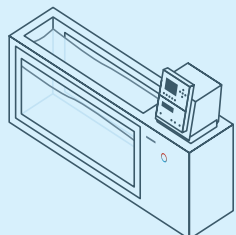

PV 36 C

646 mm



PV 15
PVL 15

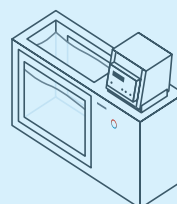

PV 24
PVL 24

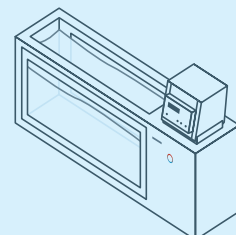

PV 36

646 mm

LAUDA Heating thermostats

Function overview

Operating element	Alpha	ECO S	ECO G	PRO Base	PRO Command Touch	Proline Master	Proline Command
Display	7-Segment	LCD mono	TFT	OLED	TFT	7-Segment	LCD mono
Mode of operation	3-button	3-button softkey	Cursor softkey	Cursor softkey	Multi-touch	4-button	Cursor softkey
Removable control	-	-	-	✓	✓	-	✓
User management	-	-	-	-	✓	-	-
Data logging, export to USB stick	-	-	-	-	✓	-	-
1-point calibration	✓	✓	✓	✓	✓	✓	✓
2-point calibration	-	-	-	✓	✓	-	-
Programmer, programs/segments	-	1 / 20	5 / 150	1 / 20	100 / 5000	-	5 / 150
Programmer, tolerance range function	-	✓	✓	✓	✓	-	✓
Ramp function	-	-	-	-	✓	-	✓
Timer function	-	-	-	-	✓	-	✓
Countdown function	✓	-	-	-	✓	-	✓
Graphic temperature profile display	-	-	✓	-	✓	-	✓
Adjustable bypass	-	-	-	-	-	✓	✓
Level indicator (digital)	-	-	-	✓	✓	✓	✓
Standby timer	-	✓	✓	✓	✓	✓	✓
Low-level alarm	✓	✓	✓	✓	✓	✓	✓
Drain tap	-	✓	✓	✓	✓	✓	✓
Drain screw	✓	-	-	-	-	-	-

LAUDA Heating thermostats

Technical data according to DIN 12876 standard

Device type	Working temperature range °C	Working temperature range with water cooling °C	Operating temperature range °C	Temperature stability ±K	Safety fittings	Heater power max. kW	Pump type	Pump pressure max. bar	Pump suction max. bar	Pump flow max. pressure L./min	Pump flow max. suction L./min	Pump connection thread mm	Nipples Øe	Bath volume min. L
LAUDA Alpha / Page 36														
A	25 ... 100	20 ... 100	-25 ... 100	0.05	I, NFL	1.5	D	0.2	-	15.0	-	N/A	-	-
A 6	25 ... 100	20 ... 100	-25 ... 100	0.05	I, NFL	1.5	D	0.2	-	15.0	-	N/A	-	2.5
A 12	25 ... 100	20 ... 100	-25 ... 100	0.05	I, NFL	1.5	D	0.2	-	15.0	-	N/A	-	8.0
A 24	25 ... 100	20 ... 100	-25 ... 100	0.05	I, NFL	1.5	D	0.2	-	15.0	-	N/A	-	18.0
LAUDA ECO / Page 38														
Silver	20 ... 200	20 ... 200	-20 ... 200	0.01	III, FL	2.0	V	0.55	-	22.0	-	N/A	-	-
ET 6 S	20 ... 100	20 ... 100	-20 ... 100	0.01	III, FL	2.0	V	0.55	-	22.0	-	N/A	-	5.0
ET 12 S	20 ... 100	20 ... 100	-20 ... 100	0.01	III, FL	2.0	V	0.55	-	22.0	-	N/A	-	9.5
ET 15 S	20 ... 100	20 ... 100	-20 ... 100	0.01	III, FL	2.0	V	0.55	-	22.0	-	N/A	13	13.5
ET 20 S	20 ... 100	20 ... 100	-20 ... 100	0.01	III, FL	2.0	V	0.55	-	22.0	-	N/A	-	15.0
E 4 S	20 ... 200	20 ... 200	-20 ... 200	0.01	III, FL	2.0	V	0.55	-	22.0	-	N/A	13	3.0
E 10 S	20 ... 200	20 ... 200	-20 ... 200	0.01	III, FL	2.0	V	0.55	-	22.0	-	N/A	-	7.5
E 20 S	20 ... 200	20 ... 200	-20 ... 200	0.01	III, FL	2.0	V	0.55	-	22.0	-	N/A	-	13.0
E 25 S	20 ... 200	20 ... 200	-20 ... 200	0.01	III, FL	2.0	V	0.55	-	22.0	-	N/A	-	16.0
E 40 S	20 ... 200	20 ... 200	-20 ... 200	0.01	III, FL	2.0	V	0.55	-	22.0	-	N/A	-	32.0
Gold	20 ... 200	20 ... 200	-20 ... 200	0.01	III, FL	2.6	V	0.55	-	22.0	-	N/A	-	-
ET 6 G	20 ... 100	20 ... 100	-20 ... 100	0.01	III, FL	2.6	V	0.55	-	22.0	-	N/A	-	5.0
ET 12 G	20 ... 100	20 ... 100	-20 ... 100	0.01	III, FL	2.6	V	0.55	-	22.0	-	N/A	-	9.5
ET 15 G	20 ... 100	20 ... 100	-20 ... 100	0.01	III, FL	2.6	V	0.55	-	22.0	-	M16×1	-	13.5
ET 20 G	20 ... 100	20 ... 100	-20 ... 100	0.01	III, FL	2.6	V	0.55	-	22.0	-	N/A	-	15.0
E 4 G	20 ... 200	20 ... 200	-20 ... 200	0.01	III, FL	2.6	V	0.55	-	22.0	-	M16×1	-	3.0
E 10 G	20 ... 200	20 ... 200	-20 ... 200	0.01	III, FL	2.6	V	0.55	-	22.0	-	N/A	-	7.5
E 20 G	20 ... 200	20 ... 200	-20 ... 200	0.01	III, FL	2.6	V	0.55	-	22.0	-	N/A	-	13.0
E 25 G	20 ... 200	20 ... 200	-20 ... 200	0.01	III, FL	2.6	V	0.55	-	22.0	-	N/A	-	16.0
E 40 G	20 ... 200	20 ... 200	-20 ... 200	0.01	III, FL	2.6	V	0.55	-	22.0	-	N/A	-	32.0

* D: Pressure pump (for circulation of the heat transfer liquid)
V: Variopump (pressure pump, with different performance levels)

Bath volume max. L	Bath opening (W x D) mm	Bath depth mm	Usable depth mm	Height top of bath mm	Dimensions (W x D x H) mm	Weight kg	Power supply V; Hz	Loading max. kW	Part Number	Device type
50.0	-	150	100	-	125×150×300	3.6	230 V; 50 Hz & 220 V; 60 Hz	1.5	L000618	A
5.5	145×161	150	130	212	181×332×370	6.5	230 V; 50 Hz & 220 V; 60 Hz	1.5	L000619	A 6
12.0	235×161	200	180	262	270×332×420	7.7	230 V; 50 Hz & 220 V; 60 Hz	1.5	L000620	A 12
25.0	295×374	200	180	262	332×535×420	10.5	230 V; 50 Hz & 220 V; 60 Hz	1.5	L000621	A 24
-	-	150	-	-	130×135×325	3.2	230 V; 50/60 Hz	2.1	L001076	SILVER
6.0	130×285	160	140	169	143×433×349	4.5	230 V; 50/60 Hz	2.1	L001096	ET 6 S
12.0	300×175	160	140	208	322×331×389	7.1	230 V; 50/60 Hz	2.1	L001097	ET 12 S
15.0	275×130	310	290	356	428×148×532	6.5	230 V; 50/60 Hz	2.1	L001098	ET 15 S
20.0	300×350	160	140	208	322×506×389	9.5	230 V; 50/60 Hz	2.1	L001099	ET 20 S
3.5	135×105	150	130	196	168×272×376	6.5	230 V; 50/60 Hz	2.1	L001084	E 4 S
11.0	300×190	150	130	196	331×361×376	8.5	230 V; 50/60 Hz	2.1	L001085	E 10 S
19.0	300×365	150	130	196	331×537×376	10.0	230 V; 50/60 Hz	2.1	L001087	E 20 S
25.0	300×365	200	180	246	331×537×426	13.5	230 V; 50/60 Hz	2.1	L001088	E 25 S
40.0	300×613	200	180	248	350×803×428	25.5	230 V; 50/60 Hz	2.1	L001089	E 40 S
-	-	150	-	-	130×135×325	3.4	230 V; 50/60 Hz	2.7	L001077	GOLD
6.0	130×285	160	140	169	143×433×349	5.0	230 V; 50/60 Hz	2.7	L001100	ET 6 G
12.0	300×175	160	140	208	322×331×389	8.0	230 V; 50/60 Hz	2.7	L001101	ET 12 G
15.0	275×130	310	290	356	428×148×532	6.7	230 V; 50/60 Hz	2.7	L001102	ET 15 G
20.0	300×350	160	140	208	322×506×389	10.0	230 V; 50/60 Hz	2.7	L001103	ET 20 G
3.5	135×105	150	130	196	168×272×376	6.5	230 V; 50/60 Hz	2.7	L001090	E 4 G
11.0	300×190	150	130	196	331×361×376	9.0	230 V; 50/60 Hz	2.7	L001091	E 10 G
19.0	300×365	150	130	196	331×537×376	10.0	230 V; 50/60 Hz	2.7	L001093	E 20 G
25.0	300×365	200	180	246	331×537×426	12.5	230 V; 50/60 Hz	2.7	L001094	E 25 G
40.0	300×613	200	180	248	350×803×428	19.5	230 V; 50/60 Hz	2.7	L001095	E 40 G

LAUDA Heating thermostats

Technical data according to DIN 12876 standard

Device type	Working temperature range °C	Working temperature range with water cooling °C	Operating temperature range °C	Temperature stability ±K	Safety fittings	Heater power max. kW	Pump type	Pump pressure max. bar	Pump suction max. bar	Pump flow max. pressure L /min	Pump flow max. suction L/min	Pump connection thread mm	Nipples Øe	Bath volume min. L
LAUDA PRO / Page 40														
P 10	40 ... 250	20 ... 250	-30 ... 250	0.01	III, FL	3.6	V	-	-	-	-	N/A	-	5.0
P 20	35 ... 250	20 ... 250	-30 ... 250	0.01	III, FL	3.6	V	-	-	-	-	N/A	-	11.0
P 30	30 ... 250	20 ... 250	-30 ... 250	0.01	III, FL	3.6	V	-	-	-	-	N/A	-	15.0
P 10 C	40 ... 250	20 ... 250	-30 ... 250	0.01	III, FL	3.6	V	-	-	-	-	N/A	-	5.0
P 20 C	35 ... 250	20 ... 250	-30 ... 250	0.01	III, FL	3.6	V	-	-	-	-	N/A	-	11.0
P 30 C	30 ... 250	20 ... 250	-30 ... 250	0.01	III, FL	3.6	V	-	-	-	-	N/A	-	15.0
LAUDA Proline Bridge thermostat / Page 42														
PB	30 ... 300	20 ... 300	-30 ... 300	0.01	III, FL	3.6	VF	0.7	0.4	25.0	23	M16×1	13	0.0
PBD	30 ... 300	20 ... 300	-30 ... 300	0.01	III, FL	3.6	V	1.1	-	32.0	-	M16×1	13	0.0
PB C	30 ... 300	20 ... 300	-30 ... 300	0.01	III, FL	3.6	VF	0.7	0.4	25.0	23	M16×1	13	0.0
PBDC	30 ... 300	20 ... 300	-30 ... 300	0.01	III, FL	3.6	V	1.1	-	32.0	-	M16×1	13	0.0
LAUDA Proline Clear-view thermostat / Page 44														
PV 15	30 ... 230	20 ... 230	0 ... 230	0.01	III, FL	3.6	V	0.8	-	25.0	-	M16×1	13	11.0
PV 24	30 ... 230	20 ... 230	0 ... 230	0.01	III, FL	3.6	V	0.8	-	25.0	-	M16×1	13	19.0
PV 36	30 ... 230	20 ... 230	0 ... 230	0.01	III, FL	3.6	V	0.8	-	25.0	-	M16×1	13	28.0
PVL 15	30 ... 100	20 ... 100	-60 ... 100	0.01	III, FL	3.6	V	0.8	-	25.0	-	M16×1	13	11.0
PVL 24	30 ... 100	20 ... 100	-60 ... 100	0.01	III, FL	3.6	V	0.8	-	25.0	-	M16×1	13	19.0
PV 15 C	30 ... 230	20 ... 230	0 ... 230	0.01	III, FL	3.6	V	0.8	-	25.0	-	M16×1	13	11.0
PV 24 C	30 ... 230	20 ... 230	0 ... 230	0.01	III, FL	3.6	V	0.8	-	25.0	-	M16×1	13	19.0
PV 36 C	30 ... 230	20 ... 230	0 ... 230	0.01	III, FL	3.6	V	0.8	-	25.0	-	M16×1	13	28.0
PVL 15 C	30 ... 100	20 ... 100	-60 ... 100	0.01	III, FL	3.6	V	0.8	-	25.0	-	M16×1	13	11.0
PVL 24 C	30 ... 100	20 ... 100	-60 ... 100	0.01	III, FL	3.6	V	0.8	-	25.0	-	M16×1	13	19.0

* V: Variopump (pressure pump, with different performance levels)

VF: Varioflex pump (pressure-suction pump with 8 pump levels)

Bath volume max. L	Bath opening (W x D) mm	Bath depth mm	Usable depth mm	Height top of bath mm	Dimensions (W x D x H) mm	Weight kg	Power supply V; Hz	Loading max. kW	Part Number	Device type
10.0	240 x 150	200	180	250	310 x 335 x 365	14.5	200-230 V; 50/60 Hz	3.7	L000001	P 10
20.0	300 x 290	200	180	250	350 x 475 x 365	19.0	200-230 V; 50/60 Hz	3.7	L000002	P 20
28.5	340 x 385	200	180	250	400 x 600 x 365	25.0	200-230 V; 50/60 Hz	3.7	L000003	P 30
10.0	240 x 150	200	180	250	310 x 335 x 415	15.0	200-230 V; 50/60 Hz	3.7	L000004	P 10 C
20.0	300 x 290	200	180	250	350 x 475 x 415	19.5	200-230 V; 50/60 Hz	3.7	L000005	P 20 C
28.5	340 x 385	200	180	250	400 x 600 x 415	24.0	200-230 V; 50/60 Hz	3.7	L000006	P 30 C
80.0	-	200	-	-	320 x 185 x 400	8.0	230 V; 50/60 Hz	3.7	L001542	PB
80.0	-	320	-	-	320 x 185 x 400	8.0	230 V; 50/60 Hz	3.7	L001544	PBD
80.0	-	200	-	-	320 x 185 x 576	8.0	230 V; 50/60 Hz	3.7	L001543	PB C
80.0	-	320	-	-	320 x 185 x 576	8.0	230 V; 50/60 Hz	3.7	L001545	PBD C
15.0	230 x 135	320	285	390	506 x 282 x 590	26.0	230 V; 50/60 Hz	3.7	L001532	PV 15
24.0	405 x 135	320	285	390	740 x 282 x 590	36.0	230 V; 50/60 Hz	3.7	L001533	PV 24
36.0	585 x 135	320	285	390	1040 x 282 x 590	44.0	230 V; 50/60 Hz	3.7	L001534	PV 36
15.0	230 x 135	320	285	390	506 x 282 x 590	28.0	230 V; 50/60 Hz	3.7	L001538	PVL 15
24.0	405 x 135	320	285	390	740 x 282 x 590	39.0	230 V; 50/60 Hz	3.7	L001539	PVL 24
15.0	230 x 135	320	285	390	506 x 282 x 646	26.0	230 V; 50/60 Hz	3.7	L001535	PV 15 C
24.0	405 x 135	320	285	390	740 x 282 x 646	36.0	230 V; 50/60 Hz	3.7	L001536	PV 24 C
36.0	585 x 135	320	285	390	1040 x 282 x 646	44.0	230 V; 50/60 Hz	3.7	L001537	PV 36 C
15.0	230 x 135	320	285	390	506 x 282 x 646	28.0	230 V; 50/60 Hz	3.7	L001540	PVL 15 C
24.0	405 x 135	320	285	390	740 x 282 x 646	39.0	230 V; 50/60 Hz	3.7	L001541	PVL 24 C

LAUDA Heating thermostats

Power supply variants

Device type	Power supply V; Hz	Heater power max. kW	Loading max. kW	Plug code*	Part Number	Device type	Power supply V; Hz	Heater power max. kW	Loading max. kW	Plug code*	Part Number
LAUDA Alpha / Page 36											
A	100 V; 50/60 Hz	1.0	1.0	14	L000634	A 12	115 V; 60 Hz	1.2	1.2	14	L000632
A	115 V; 60 Hz	1.2	1.2	14	L000630	A 24	115 V; 60 Hz	1.2	1.2	14	L000633
A 6	100 V; 50/60 Hz	1.0	1.0	14	L000635						
A 6	115 V; 60 Hz	1.2	1.2	14	L000631						
LAUDA ECO / Page 38											
Silver	100 V; 50/60 Hz	1.0	1.1	14	L001082	E 40 S	100 V; 50/60 Hz	1.0	1.1	14	L001225
Silver	115 V; 60 Hz	1.3	1.4	14	L001080	E 40 S	115 V; 60 Hz	1.3	1.4	14	L001196
Silver	220 V; 60 Hz	1.9	2.0	3	L001078	E 40 S	220 V; 60 Hz	1.8	2.1	3	L001176
ET 6 S	100 V; 50/60 Hz	1.0	1.1	14	L001232	Gold	100 V; 50/60 Hz	1.0	1.1	14	L001083
ET 6 S	115 V; 60 Hz	1.3	1.4	14	L001203	Gold	115 V; 60 Hz	1.3	1.4	14	L001081
ET 6 S	220 V; 60 Hz	1.8	2.0	3	L001183	Gold	220 V; 60 Hz	2.4	2.5	3	L001079
ET 12 S	100 V; 50/60 Hz	1.0	1.1	14	L001233	ET 6 G	100 V; 50/60 Hz	1.0	1.1	14	L001236
ET 12 S	115 V; 60 Hz	1.3	1.4	14	L001204	ET 6 G	115 V; 60 Hz	1.3	1.4	14	L001207
ET 12 S	220 V; 60 Hz	1.8	2.7	3	L001184	ET 6 G	220 V; 60 Hz	2.4	2.5	3	L001187
ET 15 S	100 V; 50/60 Hz	1.0	1.1	14	L001234	ET 12 G	100 V; 50/60 Hz	1.0	1.1	14	L001237
ET 15 S	115 V; 60 Hz	1.3	1.4	14	L001205	ET 12 G	115 V; 60 Hz	1.3	1.4	14	L001208
ET 15 S	220 V; 60 Hz	1.8	2.7	3	L001185	ET 12 G	220 V; 60 Hz	2.4	2.5	3	L001188
ET 20 S	100 V; 50/60 Hz	1.0	1.1	14	L001235	ET 15 G	100 V; 50/60 Hz	1.0	1.1	14	L001238
ET 20 S	115 V; 60 Hz	1.3	1.4	14	L001206	ET 15 G	115 V; 60 Hz	1.3	1.4	14	L001209
ET 20 S	220 V; 60 Hz	1.8	2.7	3	L001186	ET 15 G	220 V; 60 Hz	2.4	2.5	3	L001189
E 4 S	100 V; 50/60 Hz	1.0	1.1	14	L001220	ET 20 G	100 V; 50/60 Hz	1.0	1.1	14	L001239
E 4 S	115 V; 60 Hz	1.3	1.4	14	L001191	ET 20 G	115 V; 60 Hz	1.3	1.4	14	L001210
E 4 S	220 V; 60 Hz	1.8	2.1	3	L001171	ET 20 G	220 V; 60 Hz	2.4	2.5	3	L001190
E 10 S	100 V; 50/60 Hz	1.0	1.1	14	L001221	E 4 G	100 V; 50/60 Hz	1.0	1.1	14	L001226
E 10 S	115 V; 60 Hz	1.3	1.4	14	L001192	E 4 G	115 V; 60 Hz	1.3	1.4	14	L001197
E 10 S	220 V; 60 Hz	1.8	2.1	3	L001172	E 4 G	220 V; 60 Hz	2.4	2.5	3	L001177
E 20 S	100 V; 50/60 Hz	1.0	1.1	14	L001223	E 10 G	100 V; 50/60 Hz	1.0	1.1	14	L001227
E 20 S	115 V; 60 Hz	1.3	1.4	14	L001194	E 10 G	115 V; 60 Hz	1.3	1.4	14	L001198
E 20 S	220 V; 60 Hz	1.8	2.1	3	L001174	E 10 G	220 V; 60 Hz	2.4	2.5	3	L001178
E 25 S	100 V; 50/60 Hz	1.0	1.1	14	L001224	E 10 G	100 V; 50/60 Hz	1.0	1.1	14	L001227
E 25 S	115 V; 60 Hz	1.3	1.4	14	L001195	E 10 G	115 V; 60 Hz	1.3	1.4	14	L001198
E 25 S	220 V; 60 Hz	1.8	2.1	3	L001175	E 10 G	220 V; 60 Hz	2.4	2.5	3	L001178

Device type	Power supply V; Hz	Heater power max. kW	Loading max. kW	Plug code*	Part Number	Device type	Power supply V; Hz	Heater power max. kW	Loading max. kW	Plug code*	Part Number
LAUDA ECO / Page 38											
E 20 G	100 V; 50/60 Hz	1.0	1.1	14	L001229	E 40 G	100 V; 50/60 Hz	1.0	1.1	14	L001231
E 20 G	115 V; 60 Hz	1.3	1.4	14	L001200	E 40 G	115 V; 60 Hz	1.3	1.4	14	L001202
E 20 G	220 V; 60 Hz	2.4	2.5	3	L001180	E 40 G	220 V; 60 Hz	2.4	2.5	3	L001182
E 25 G	100 V; 50/60 Hz	1.0	1.1	14	L001230						
E 25 G	115 V; 60 Hz	1.3	1.4	14	L001201						
E 25 G	220 V; 60 Hz	2.4	2.5	3	L001181						
LAUDA PRO / Page 40											
P 10	100-120 V; 50/60 Hz	1.9	1.9	32	L000554	P 10 C	100-120 V; 50/60 Hz	1.9	1.9	4	L000550
P 10	100-120 V; 50/60 Hz	1.9	1.9	4	L000546	P 10 C	100-120 V; 50/60 Hz	1.9	1.9	32	L000558
P 20	100-120 V; 50/60 Hz	1.9	1.9	4	L000547	P 20 C	100-120 V; 50/60 Hz	1.9	1.9	32	L000559
P 20	100-120 V; 50/60 Hz	1.9	1.9	32	L000555	P 20 C	100-120 V; 50/60 Hz	1.9	1.9	4	L000551
P 30	100-120 V; 50/60 Hz	1.9	1.9	4	L000548	P 30 C	100-120 V; 50/60 Hz	1.9	1.9	32	L000560
P 30	100-120 V; 50/60 Hz	1.9	1.9	32	L000556	P 30 C	100-120 V; 50/60 Hz	1.9	1.9	4	L000552
LAUDA Proline Bridge thermostat / Page 42											
PB	100 V; 50/60 Hz	1.3	1.5	4	L001590	PB C	100 V; 50/60 Hz	1.3	1.5	4	L001591
PB	115 V; 60 Hz	1.7	1.9	4	L001580	PB C	115 V; 60 Hz	1.7	1.9	4	L001581
PBD	100 V; 50/60 Hz	1.3	1.5	4	L001592	PBD C	100 V; 50/60 Hz	1.3	1.5	4	L001593
PBD	115 V; 60 Hz	1.7	1.9	4	L001582	PBD C	115 V; 60 Hz	1.7	1.9	4	L001583
LAUDA Proline Clear-view thermostat / Page 44											
PV 15	100 V; 50/60 Hz	1.3	1.5	4	L001584	PV 15 C	100 V; 50/60 Hz	1.3	1.5	4	L001585
PV 15	115 V; 60 Hz	1.7	1.9	4	L001574	PV 15 C	115 V; 60 Hz	1.7	1.9	4	L001575
PV 24	200 V; 50/60 Hz	2.7	2.9	3	L001594	PV 24 C	200 V; 50/60 Hz	2.7	2.9	3	L001596
PV 24	208-220 V; 60 Hz	3.3	3.5	3	L001598	PV 24 C	208-220 V; 60 Hz	3.3	3.5	3	L001600
PV 36	200 V; 50/60 Hz	2.7	2.9	3	L001595	PV 36 C	200 V; 50/60 Hz	2.7	2.9	3	L001597
PV 36	208-220 V; 60 Hz	3.3	3.5	3	L001599	PV 36 C	208-220 V; 60 Hz	3.3	3.5	3	L001601
PVL 15	100 V; 50/60 Hz	1.3	1.5	4	L001586	PVL 15 C	100 V; 50/60 Hz	1.3	1.5	4	L001588
PVL 15	115 V; 60 Hz	1.7	1.9	4	L001576	PVL 15 C	115 V; 60 Hz	1.7	1.9	4	L001578
PVL 24	100 V; 50/60 Hz	1.3	1.5	4	L001587	PVL 24 C	100 V; 50/60 Hz	1.3	1.5	4	L001589
PVL 24	115 V; 60 Hz	1.7	1.9	4	L001577	PVL 24 C	115 V; 60 Hz	1.7	1.9	4	L001579

*All data for the plug codes can be found on page 162

LAUDA Heating thermostats

More characteristics

LAUDA Alpha / Page 36

PUMP CHARACTERISTIC Water

Pressure bar

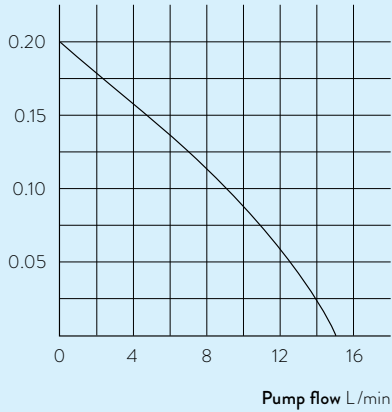

LAUDA ECO / Page 38

HEATING PERFORMANCE Heat transfer liquid: Therm 240, bath closed

Bath temperature °C

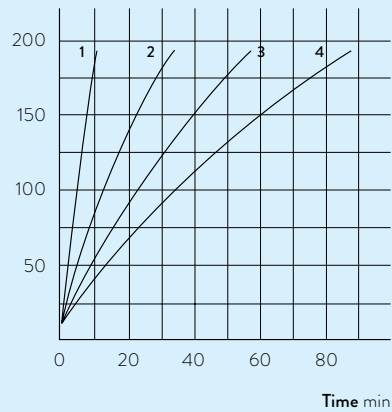

- 1 E 4 S
- 2 E 10 S
- 3 E 20 S
- 4 E 25 S

HEATING PERFORMANCE Heat transfer liquid: Water, bath closed

Bath temperature °C

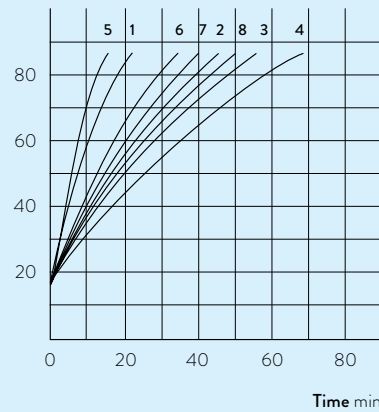

- 1 ET 12 S
- 2 ET 15 S
- 3 ET 20 S
- 4 ET 25 S
- 5 ET 6 G
- 6 ET 12 G
- 7 ET 15 G
- 8 ET 20 G

PUMP CHARACTERISTIC Water

Pressure bar

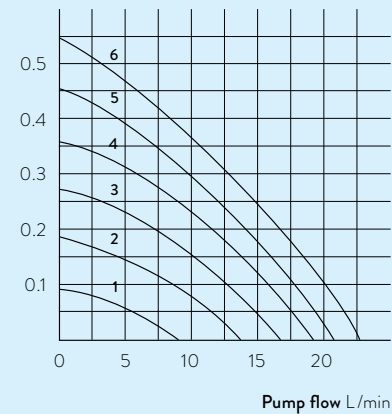

- 1 Step 1
- 2 Step 2
- 3 Step 3
- 4 Step 4
- 5 Step 5
- 6 Step 6

PUMP CHARACTERISTIC for PB and PBC, Water

Pressure bar

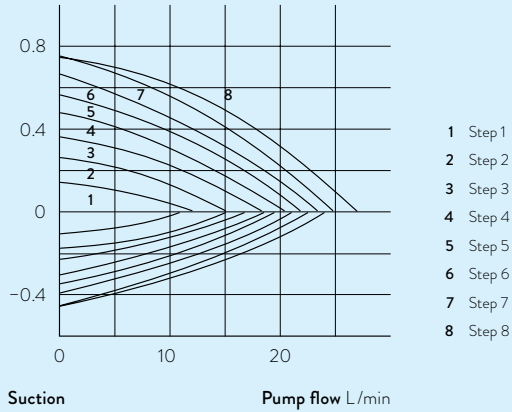

Suction

Pump flow L/min

PUMP CHARACTERISTIC for PBD and PBD C, Water

Pressure bar

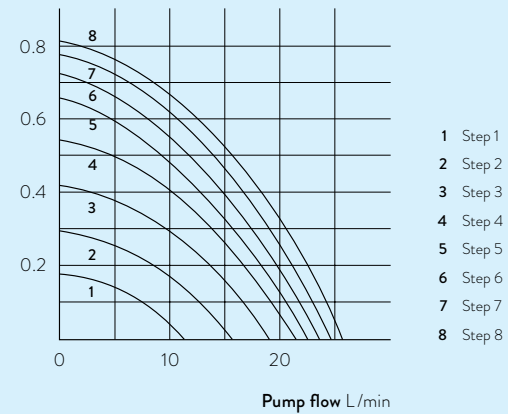

Pump flow L/min

LAUDA

COOLING THERMOSTATS

°LAUDA



Specific application examples

- Sample preparation in chemistry and pharmacy
- Functional testing of electronic components
- Test of slide bearings
- Valve testing
- Stress test
- Notch bending test
- Expansion testing
- Brookfield test
- Semi-conductor coating



LAUDA Alpha

Affordable cooling thermostats for maintaining temperatures from -25 to 100 °C in the lab

-25 °C  100 °C

The cost-efficient choice for high-quality LAUDA thermostats

LAUDA Alpha offers reliable technology for temperature ranges from -25 to 100 °C. This line of devices is suitable for internal and external temperature control thermostating with non-flammable liquids (water and water/glycol). The thermostats are the perfect solution for most basic temperature control applications in the lab. Optimized down to the most essential functions, this affordable product line will win you over with its reliability and user-friendliness.

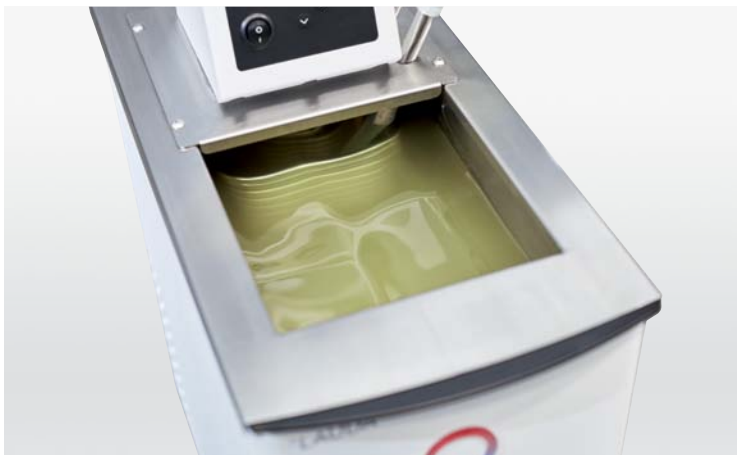

Cost savings through automatic compressor control: Cooling capacity is only provided when it is needed



Easy cleaning of the cooling air inlet enabled by simple removal of front cover without tools

COOLING PERFORMANCE Heat transfer liquid: Ethanol, bath closed

Bath temperature °C

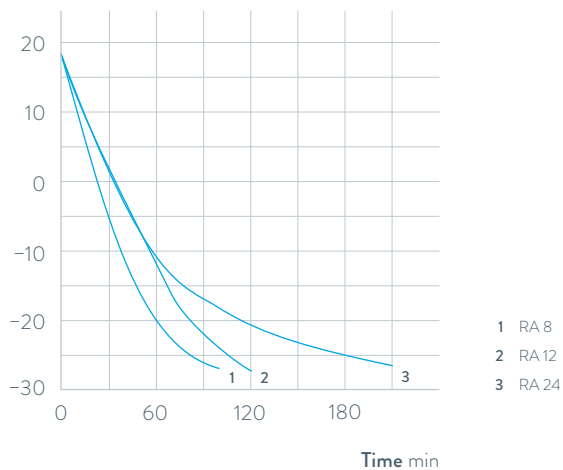

Important functions

- Stainless steel bath vessels
- Drain connection at the rear

Included accessories

Pump circulation set, bath cover, pump link for pump connections

Further accessories

Racks, tubing

All technical data and power supply variants can be found in the ›Technical data‹ section.

More at www.lauda.de/1736



LAUDA Alpha

The cooling thermostats RA 8, RA 12 and RA 24, including standard-issue bath covers and pump connections, facilitate cooling across the entire temperature range from -25 to 100 °C. Automatic compressor control extends the service life of the compressor and offers savings on operation costs.



LAUDA ECO

From -50 to 200 °C: Cooling thermostats for economic temperature control in the lab



Impressive range of capabilities coupled with easy operation

The ECO thermostats are available in Silver (LCD) or Gold (color TFT display) models with a large number of interface modules as accessories. The circulation pump can be adjusted to six levels. The comprehensive model portfolio offers devices with cooling capacities of 180 to 700 watts and minimum temperatures of -15 to -50 °C. The devices of the LAUDA ECO series with the highest performance work with an energy-saving LAUDA SmartCool system, which automatically adjusts the cooling capacity to the required operating status.

The low-temperature thermostats are also available with natural refrigerants as standard for extra environmentally-friendly operation.



Plain text menu guidance on a monochrome LCD (Silver) or color TFT display (Gold) for easy and intuitive operation



Standard pump connections for temperature control of external applications

COOLING PERFORMANCE Heat transfer liquid: Ethanol, bath closed

Bath temperature °C

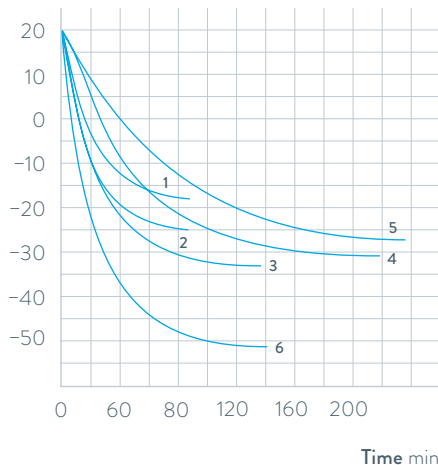

- 1 RE 415 G
- 2 RE 420 G
- 3 RE 630 G
- 4 RE 1225 G
- 5 RE 2025 G
- 6 RE 1050 G

Important functions

- Integrated programmer for automating temperature profiles
- Adjustment of flow rate switch for internal/external circulation, can be actuated from exterior during operation
- USB interface as standard

Included accessories

Bath cover, pump connections, closing plugs

Further accessories

Tubing, interface modules (P. 69)

All technical data and power supply variants can be found in the ›Technical data‹ section.

More at www.lauda.de/1738



LAUDA ECO

The cooling thermostats come with a bath cover and pump connections as standard. A drain tap on the back side of the device makes changing the heat transfer liquid easy and safe.



LAUDA PRO

Cooling bath thermostats for professional temperature control from -100 to 200 °C



Flexible operation, outstanding performance

With LAUDA PRO, customers gain access to a cutting-edge product line with an outstanding overall concept. There are two operating units available: Base or Command Touch. These can be removed from the thermostat for very high levels of flexibility. On the one hand, this permits remote control of the devices and on the other hand, this considerably reduces the height of the devices. In addition, they are also equipped with a hybrid cooling system as standard. This enables additional cooling of the refrigerating machine with water.



Low device height and 360° accessibility of the bath thanks to detachable remote control

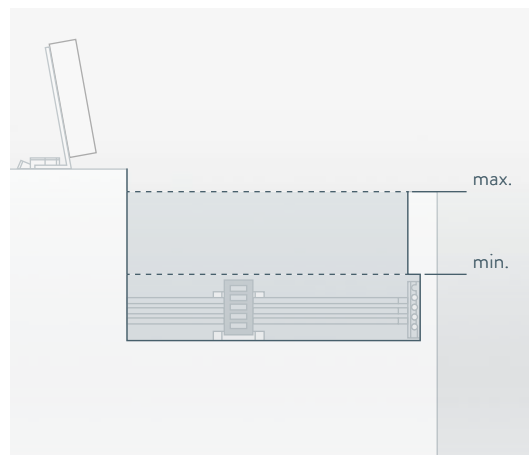

Full functionality of the bath with low minimum fill height

COOLING PERFORMANCE Heat transfer liquid: Ethanol, bath closed

Bath temperature °C

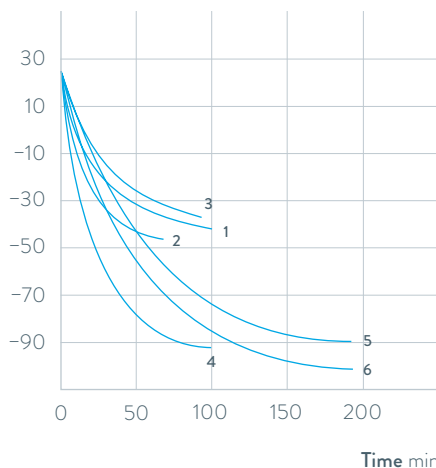

- 1 RP 2040 C
- 2 RP 2045 C
- 3 RP 3035 C
- 4 RP 1090 C
- 5 RP 2090 C
- 6 RP 10100 C

Important functions

- Internal LAUDA Vario Pump with 8 selectable output levels
- Hybrid cooling of the refrigerating machine permits cooling using ambient air or, in addition, using cooling water
- Standard bath edge heating on all types prevents the formation of ice on the surface of the bath cover
- Ethernet, USB and Pt100 as standard

Included accessories

Bath cover, tubing nipples with screw caps for the cooling coil

Further accessories

External pump, interface modules

All technical data and power supply variants can be found in the [Technical data](#) section.

More at www.lauda.de/1740



LAUDA PRO

The PRO cooling bath thermostats for internal bath applications offer a working temperature range from -100 to 200 °C. An incrementally adjustable pump ensures excellent homogeneity of the bath. With their bath sizes from 10 to 30 liters and cooling capacity from 0.4 to 1.5 kW, the thermostats are suitable for a wide range of applications.



LAUDA Proline Kryomats

High-performance cooling thermostats from -90 to 200°C for use in process technology and material testing



High cooling performance and compact design

The Proline Kryomats are cooling thermostats that feature the latest technology with high efficiency and an excellent price-performance ratio. The pressure pump is optimized for internal circulation and can be set to four levels – the standard-issue LAUDA Command remote control also makes it especially user-friendly. Furthermore, integrated bath edge and bath bridge heating prevent the formation of condensation caused by air humidity at low temperatures.

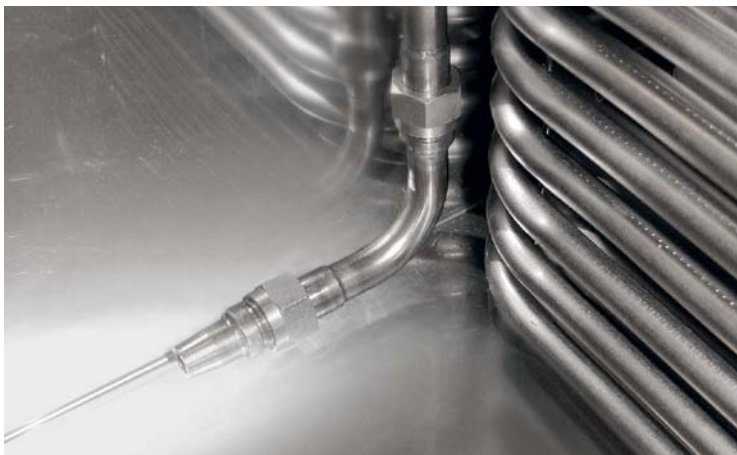

Optimal circulation and temperature distribution throughout the entire bath thanks to an adjustable pump nozzle



Spacious baths and large bath openings – ideal for bulky test specimens and effective throughput

COOLING PERFORMANCE Heat transfer liquid: Ethanol, bath closed

Bath temperature $^{\circ}\text{C}$

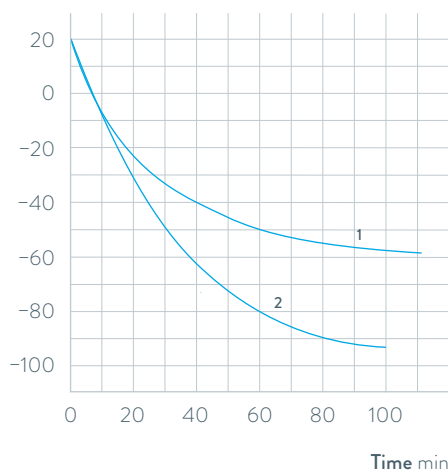

1 RP 4050 C
2 RP 4090 C

Important functions

- Removable Command operating unit with high-resolution, graphic LCD screen and individually selectable display functions
- Programmer with 150 temperature/time segments, can be divided into 5 programs
- Pump connections on side and rear, integrated bypass

Included accessories

Bath cover, tubing nipples

Further accessories

Inset baskets, interface modules

All technical data and power supply variants can be found in the [Technical data](#) section.

More at www.lauda.de/1742



LAUDA Proline Kryomats

The air and water-cooled versions of the Proline Kryomats are available with large bath openings and volumes of 30 and 40 liters.



LAUDA Cooling thermostats

Device type overview

LAUDA Alpha / Page 60

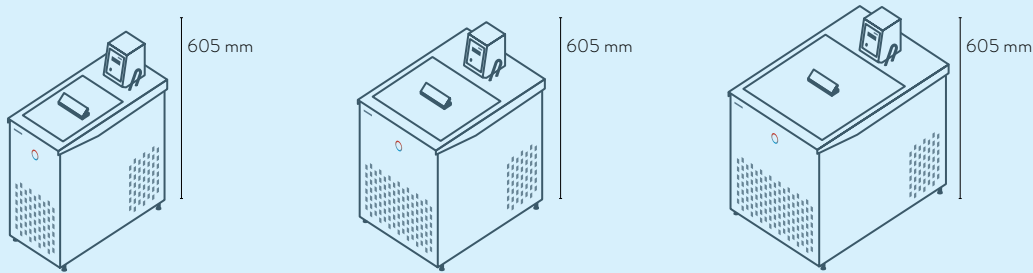

RA 8

RA 12

RA 24

LAUDA ECO / Page 62

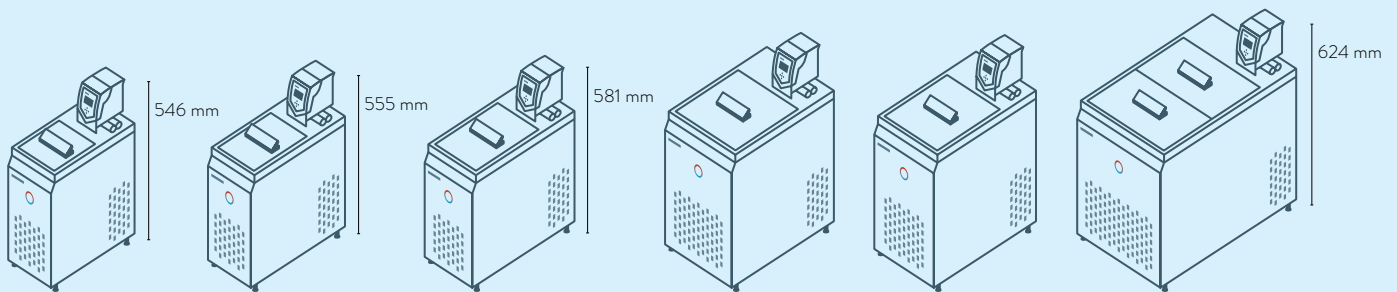

RE 415 S
RE 415 G

RE 420 S
RE 420 G

RE 630 S
RE 630 G

RE 1050 S
RE 1050 G

RE 1225 S
RE 1225 G

RE 2025 S
RE 2025 G

LAUDA PRO / Page 64

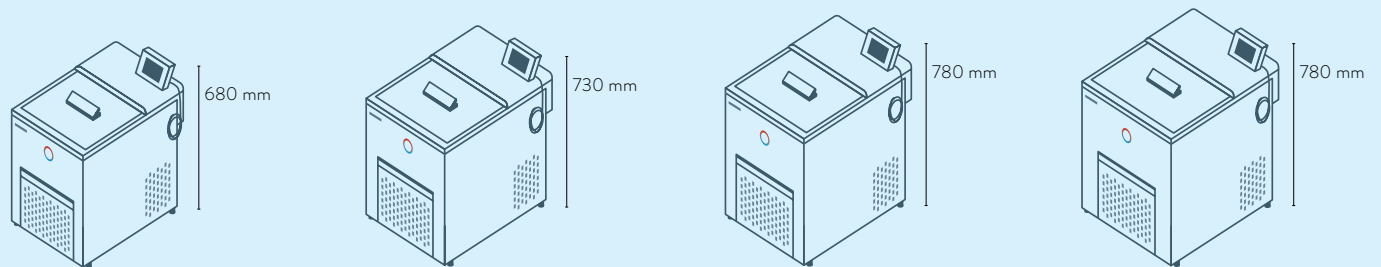

RP 2040 C
RP 2045 C

RP 3035 C

RP 1090 C

RP 2090 C
RP 10100 C

LAUDA Proline Kryomats / Page 66

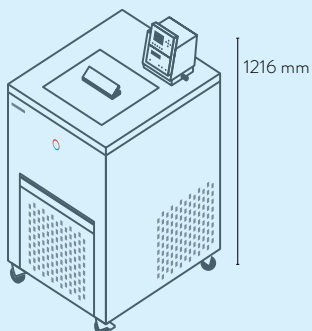

RP 4050 C / RP 4050 CW
RP 4090 C / RP 4090 CW

LAUDA Cooling thermostats

Interfaces

	Pt 100 (1)	Pt 100 (2)	USB	Ethernet	RS 232 / 485	Analog	Namur contact	D-Sub contact	PROFIBUS	EtherCAT M8	EtherCAT RJ 45	Number of module slots, large	Number of module slots, small
LAUDA Alpha / Page 60	-	-	-	-	-	-	-	-	-	-	-	-	-
LAUDA ECO / Page 62	Z	-	S	Z	Z	Z	Z	Z	Z	Z	Z	1	1
LAUDA PRO / Page 64	S	-	S	S	Z	Z	Z	Z	Z	Z	Z	1	-
LAUDA Proline Kryomat / Page 66	S	-	-	Z	S	Z	Z	Z	Z	Z	Z	2	-

S = Series standard

Z = Available as an accessory



LRZ 912
Analog module



LRZ 913
RS 232/485
interface



LRZ 914
Contact module with single input
and single output (NAMUR)



LRZ 915
Contact module with
3 inputs and 3 outputs



LRZ 917
Profibus module



LRZ 918
Pt100/Li bus module,
small cover



LRZ 921
Ethernet module



LRZ 922
EtherCAT module
with M8 connection

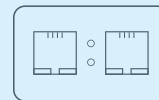

LRZ 923
EtherCAT module
with RJ45 connection



LRZ 925
External Pt100/LiBus-
module, large cover

LAUDA Cooling thermostats

Function overview

Operating element	Alpha	ECO S	ECO G	PRO Base	PRO Command Touch	Proline Kryomats
Display	7-Segment	LCD mono	TFT	OLED	TFT	LCD mono
Mode of operation	3-button	3-button softkey	Cursor softkey	Cursor softkey	Multi-touch	Cursor softkey
Removable control	-	-	-	✓	✓	✓
User management	-	-	-	-	✓	-
Data logging, export to USB stick	-	-	-	-	✓	-
1-point calibration	✓	✓	✓	✓	✓	✓
2-point calibration	-	-	-	✓	✓	-
Programmer, programs/segments	-	1 / 20	5 / 150	1 / 20	100 / 5000	5 / 150
Programmer, tolerance range function	-	✓	✓	✓	✓	✓
Ramp function	-	-	-	-	✓	✓
Timer function	-	-	-	-	✓	✓
Countdown function	✓	-	-	-	✓	✓
Graphic temperature profile display	-	-	✓	-	✓	✓
Adjustable bypass	-	-	-	-	-	✓
Level indicator (digital)	-	-	-	✓	✓	✓
Standby timer	-	✓	✓	✓	✓	✓
Low-level alarm	✓	✓	✓	✓	✓	✓
Drain tap	-	✓	✓	✓	✓	✓
Drain screw	✓	-	-	-	-	-

LAUDA Cooling thermostats

Technical data according to DIN 12876 standard

Device type	Working temperature range °C	Temperature stability ±K	Safety fittings	Heater power max. kW	Cooling output kW														Pump type	Pump pressure max. bar
					20 °C	10 °C	0 °C	-10 °C	-20 °C	-25 °C	-30 °C	-40 °C	-50 °C	-60 °C	-70 °C	-80 °C	-90 °C	-100 °C		
LAUDA Alpha / Page 60																				
RA 8	-25 ... 100	0.05	I, NFL	1.5	0.23	-	0.16	-	0.08	-	-	-	-	-	-	-	-	D	0.2	
RA 12	-25 ... 100	0.05	I, NFL	1.5	0.33	-	0.26	-	0.08	-	-	-	-	-	-	-	-	D	0.2	
RA 24	-25 ... 100	0.05	I, NFL	1.5	0.43	-	0.33	-	0.08	-	-	-	-	-	-	-	-	D	0.2	
LAUDA ECO / Page 62																				
RE 415 S	-15 ... 200	0.02	III, FL	2.0	0.18 ¹	-	0.12 ¹	-	-	-	-	-	-	-	-	-	-	V	0.55	
RE 420 S	-20 ... 200	0.02	III, FL	2.0	0.20 ¹	-	0.15 ¹	-	0.03 ¹	-	-	-	-	-	-	-	-	V	0.55	
RE 630 S	-30 ... 200	0.02	III, FL	2.0	0.30 ¹	-	0.24 ¹	-	0.10 ¹	-	0.02 ¹	-	-	-	-	-	-	V	0.55	
RE 1050 S	-50 ... 200	0.02	III, FL	2.0	0.70 ¹	-	0.60 ¹	-	0.35 ¹	-	0.19 ¹	0.10 ¹	0.02 ¹	-	-	-	-	V	0.55	
RE 1225 S	-25 ... 200	0.02	III, FL	2.0	0.30 ¹	-	0.24 ¹	-	0.09 ¹	0.04 ¹	-	-	-	-	-	-	-	V	0.55	
RE 2025 S	-25 ... 200	0.02	III, FL	2.0	0.30 ¹	-	0.23 ¹	-	0.06 ¹	0.03 ¹	-	-	-	-	-	-	-	V	0.55	
RE 415 G	-15 ... 200	0.02	III, FL	2.6	0.18 ¹	-	0.12 ¹	-	-	-	-	-	-	-	-	-	-	V	0.55	
RE 420 G	-20 ... 200	0.02	III, FL	2.6	0.20 ¹	-	0.15 ¹	-	0.03 ¹	-	-	-	-	-	-	-	-	V	0.55	
RE 630 G	-30 ... 200	0.02	III, FL	2.6	0.30 ¹	-	0.24 ¹	-	0.10 ¹	-	0.02 ¹	-	-	-	-	-	-	V	0.55	
RE 1050 G	-50 ... 200	0.02	III, FL	2.6	0.70 ¹	-	0.60 ¹	-	0.35 ¹	-	0.19 ¹	0.10 ¹	0.02 ¹	-	-	-	-	V	0.55	
RE 1225 G	-25 ... 200	0.02	III, FL	2.6	0.30 ¹	-	0.24 ¹	-	0.09 ¹	0.04 ¹	-	-	-	-	-	-	-	V	0.55	
RE 2025 G	-25 ... 200	0.02	III, FL	2.6	0.30 ¹	-	0.23 ¹	-	0.06 ¹	0.03 ¹	-	-	-	-	-	-	-	V	0.55	

¹Pump output step 2

Pump flow max. pressure L/min	Pump connection thread mm	Nipples Øe	Bath volume min. L	Bath volume max. L	Bath opening (W x D) mm	Bath depth mm	Usable depth mm	Height top of bath mm	Dimensions (W x D x H) mm	Weight kg	Power supply V; Hz	Loading max. kW	Part Number	Device type
15.0	N/A	13	5.0	7.5	165×177	160	140	450	235×500×605	29.0	230 V; 50 Hz & 220 V; 60 Hz	1.8	L000638	RA 8
15.0	N/A	13	9.5	14.5	300×203	160	140	450	365×500×605	37.0	230 V; 50 Hz & 220 V; 60 Hz	1.8	L000639	RA 12
15.0	N/A	13	14.0	22.0	350×277	160	140	450	415×605×605	43.0	230 V; 50 Hz & 220 V; 60 Hz	1.8	L000640	RA 24
22.0	-	13	3.3	4.0	130×105	160	140	365	180×350×546	20.0	230 V; 50 Hz	2.2	L002815	RE 415 S
22.0	-	13	3.3	4.0	130×105	160	140	374	180×396×555	22.0	230 V; 50 Hz	2.2	L001333	RE 420 S
22.0	-	13	4.6	5.7	150×130	160	140	400	200×430×581	27.0	230 V; 50 Hz	2.3	L001335	RE 630 S
22.0	-	13	8.0	10.0	200×200	160	140	443	280×440×624	34.0	230 V; 50 Hz	2.5	L001336	RE 1050 S
22.0	-	13	9.3	12.0	200×200	200	180	443	250×435×624	31.0	230 V; 50 Hz	2.3	L001337	RE 1225 S
22.0	-	13	14.0	20.0	300×350	160	140	443	350×570×624	38.0	230 V; 50 Hz	2.3	L001338	RE 2025 S
22.0	M16×1	13	3.3	4.0	130×105	160	140	365	180×350×546	21.0	230 V; 50 Hz	2.8	L002816	RE 415 G
22.0	M16×1	13	3.3	4.0	130×105	160	140	374	180×396×555	22.0	230 V; 50 Hz	2.8	L001339	RE 420 G
22.0	M16×1	13	4.6	5.7	150×130	160	140	400	200×430×581	24.0	230 V; 50 Hz	2.9	L001341	RE 630 G
22.0	M16×1	13	8.0	10.0	200×200	160	140	443	280×440×624	34.0	230 V; 50 Hz	3.1	L001342	RE 1050 G
22.0	M16×1	13	9.3	12.0	200×200	200	180	443	250×435×624	31.0	230 V; 50 Hz	2.9	L001343	RE 1225 G
22.0	M16×1	13	14.0	20.0	300×350	160	140	443	350×570×624	40.0	230 V; 50 Hz	2.9	L001344	RE 2025 G

LAUDA Cooling thermostats

Technical data according to DIN 12876 standard

Device type	Working temperature range °C	Temperature stability ±K	Safety fittings	Heater power max. kW	Cooling output kW														Pump type	Pump pressure max. bar
					20 °C	10 °C	0 °C	-10 °C	-20 °C	-25 °C	-30 °C	-40 °C	-50 °C	-60 °C	-70 °C	-80 °C	-90 °C	-100 °C		
LAUDA PRO / Page 64																				
RP 2040	-40 ... 200	0.01	III, FL	3.6	0.80 ³	0.80 ³	0.80 ³	0.60 ³	0.40 ²	-	0.19 ²	0.06 ²	-	-	-	-	-	-	V	-
RP 2045	-45 ... 200	0.01	III, FL	3.6	1.50 ³	1.43 ³	1.17 ³	0.84 ³	0.52 ²	-	0.28 ²	0.13 ²	-	-	-	-	-	-	V	-
RP 3035	-35 ... 200	0.01	III, FL	3.6	0.80 ³	0.80 ³	0.80 ³	0.58 ³	0.35 ²	-	0.16 ²	-	-	-	-	-	-	-	V	-
RP 1090	-90 ... 200	0.01	III, FL	3.6	0.80 ³	0.75 ³	0.72 ³	0.69 ³	0.66 ²	-	0.63 ²	0.60 ²	0.54 ²	0.37 ²	0.24 ²	0.11 ²	0.02 ²	-	V	-
RP 2090	-90 ... 200	0.01	III, FL	3.6	0.80 ³	0.71 ³	0.68 ³	0.65 ³	0.62 ²	-	0.61 ²	0.58 ²	0.52 ²	0.34 ²	0.18 ²	0.07 ²	0.01 ²	-	V	-
RP 10100	-100 ... 200	0.01	III, FL	3.6	0.40 ³	0.40 ³	0.40 ³	0.40 ³	0.40 ²	-	0.39 ²	0.37 ²	0.35 ²	0.32 ²	0.25 ²	0.17 ²	0.06 ²	0.01 ²	V	-
RP 2040 C	-40 ... 200	0.01	III, FL	3.6	0.80 ³	0.80 ³	0.80 ³	0.60 ³	0.40 ²	-	0.19 ²	0.06 ²	-	-	-	-	-	-	V	-
RP 2045 C	-45 ... 200	0.01	III, FL	3.6	1.50 ³	1.43 ³	1.17 ³	0.84 ³	0.52 ²	-	0.28 ²	0.13 ²	-	-	-	-	-	-	V	-
RP 3035 C	-35 ... 200	0.01	III, FL	3.6	0.80 ³	0.80 ³	0.80 ³	0.58 ³	0.35 ²	-	0.16 ²	-	-	-	-	-	-	-	V	-
RP 1090 C	-90 ... 200	0.01	III, FL	3.6	0.80 ³	0.75 ³	0.72 ³	0.69 ³	0.66 ²	-	0.63 ²	0.60 ²	0.54 ²	0.37 ²	0.24 ²	0.11 ²	0.02 ²	-	V	-
RP 2090 C	-90 ... 200	0.01	III, FL	3.6	0.80 ³	0.71 ³	0.68 ³	0.65 ³	0.62 ²	-	0.61 ²	0.58 ²	0.52 ²	0.34 ²	0.18 ²	0.07 ²	0.01 ²	-	V	-
RP 10100 C	-100 ... 200	0.01	III, FL	3.6	0.40 ³	0.40 ³	0.40 ³	0.40 ³	0.40 ²	-	0.39 ²	0.37 ²	0.35 ²	0.32 ²	0.25 ²	0.17 ²	0.06 ²	0.01 ²	V	-
LAUDA Proline Kryomats / Page 66																				
RP 4050 C	-50 ... 200	0.05	III, FL	3.5	5.00 ¹	-	3.00 ¹	-	1.60 ¹	-	1.00 ¹	0.50 ¹	0.25 ¹	-	-	-	-	-	V	0.5
RP 4050 CW	-50 ... 200	0.05	III, FL	3.5	6.00 ¹	-	3.50 ¹	-	1.80 ¹	-	1.10 ¹	0.60 ¹	0.25 ¹	-	-	-	-	-	V	0.5
RP 4090 C	-90 ... 200	0.05	III, FL	3.5	3.00 ¹	-	2.90 ¹	-	2.50 ¹	-	2.30 ¹	2.00 ¹	1.60 ¹	1.30 ¹	0.80 ¹	0.50 ¹	0.15 ¹	-	V	0.5
RP 4090 CW	-90 ... 200	0.05	III, FL	3.5	4.00 ¹	-	3.70 ¹	-	3.10 ¹	-	2.70 ¹	2.00 ¹	1.60 ¹	1.30 ¹	0.80 ¹	0.50 ¹	0.15 ¹	-	V	0.5

¹Pump output step 2 ²Pump output step 4 ³Pump output step 8 All device types with mark »W« are water-cooled

Pump flow max. pressure L/min	Pump connection thread mm	Nipples Øe	Bath volume min. L	Bath volume max. L	Bath opening (W x D) mm	Bath depth mm	Usable depth mm	Height top of bath mm	Dimensions (W x D x H) mm	Weight kg	Power supply V; Hz	Loading max. kW	Part Number	Device type
-	N/A	-	12.5	21.0	300×290	200	180	568	400×565×680	51.0	230 V; 50 Hz	3.7	L000007	RP 2040
-	N/A	-	12.5	21.0	300×290	200	180	568	400×565×680	59.0	230 V; 50 Hz	3.7	L000008	RP 2045
-	N/A	-	17.5	29.5	340×375	200	180	568	440×600×680	54.0	230 V; 50 Hz	3.7	L000009	RP 3035
-	N/A	-	6.5	10.5	240×150	200	180	618	440×600×730	85.0	230 V; 50 Hz	3.7	L000010	RP 1090
-	N/A	-	12.5	21.0	300×290	200	180	618	500×600×730	91.0	230 V; 50 Hz	3.7	L000011	RP 2090
-	N/A	-	6.5	10.5	240×150	200	180	618	500×600×730	86.0	230 V; 50 Hz	3.7	L000012	RP 10100
-	N/A	-	12.5	21.0	300×290	200	180	568	400×565×730	52.0	230 V; 50 Hz	3.7	L000013	RP 2040 C
-	N/A	-	12.5	21.0	300×290	200	180	568	400×565×730	59.0	230 V; 50 Hz	3.7	L000014	RP 2045 C
-	N/A	-	17.5	29.5	340×375	200	180	568	440×600×730	55.0	230 V; 50 Hz	3.7	L000015	RP 3035 C
-	N/A	-	6.5	10.5	240×150	200	180	618	440×600×780	86.0	230 V; 50 Hz	3.7	L000016	RP 1090 C
-	N/A	-	12.5	21.0	300×290	200	180	618	500×600×780	89.0	230 V; 50 Hz	3.7	L000017	RP 2090 C
-	N/A	-	6.5	10.5	240×150	200	180	618	500×600×780	86.0	230 V; 50 Hz	3.7	L000018	RP 10100 C
19.0	M16×1	13	32.0	44.0	350×350	250	230	905	600×700×1216	129.0	400 V; 3/N/PE; 50 Hz	5.0	L001653	RP 4050 C
19.0	M16×1	13	32.0	44.0	350×350	250	230	905	600×700×1216	124.0	400 V; 3/N/PE; 50 Hz	5.0	L001657	RP 4050 CW
19.0	M16×1	13	32.0	44.0	350×350	250	230	905	600×700×1216	161.0	400 V; 3/N/PE; 50 Hz	7.0	L001655	RP 4090 C
19.0	M16×1	13	32.0	44.0	350×350	250	230	905	600×700×1216	160.0	400 V; 3/N/PE; 50 Hz	7.0	L001659	RP 4090 CW

LAUDA Cooling thermostats

Power supply variants

Device type	Power supply V; Hz	Heater power max. kW	Loading max. kW	Plug code*	Part Number	Device type	Power supply V; Hz	Heater power max. kW	Loading max. kW	Plug code*	Part Number
LAUDA Alpha / Page 60											
RA 8	100 V; 50/60 Hz	1.0	1.3	14	L000653	RA 24	115 V; 60 Hz	1.2	1.5	14	L000652
RA 8	115 V; 60 Hz	1.2	1.5	14	L000650	RA 24	230 V; 50 Hz & 220 V; 60 Hz	1.4	1.8	17	L000640
RA 8	230 V; 50 Hz & 220 V; 60 Hz	1.4	1.8	17	L000638						
RA 12	115 V; 60 Hz	1.2	1.5	14	L000651						
RA 12	230 V; 50 Hz & 220 V; 60 Hz	1.4	1.8	17	L000639						
LAUDA ECO / Page 62											
RE 415 S	115 V; 60 Hz	1.3	1.4	14	L001433	RE 1050 S	100 V; 50/60 Hz	1.0	1.5	14	L001465
RE 415 S	220 V; 60 Hz	1.8	2.1	3	L001405	RE 1050 S	115 V; 60 Hz	1.3	1.4	14	L001437
RE 415 S	220 V; 60 Hz	1.8	2.1	2	L002073	RE 1050 S	220 V; 60 Hz	1.8	2.4	3	L001409
RE 415 G	115 V; 60 Hz	1.3	1.4	14	L001440	RE 1050 S	220 V; 60 Hz	1.8	2.4	2	L002077
RE 415 G	220 V; 60 Hz	2.4	2.6	3	L001412	RE 1050 G	100 V; 50/60 Hz	1.0	1.5	14	L001472
RE 415 G	220 V; 60 Hz	2.4	2.6	2	L002080	RE 1050 G	115 V; 60 Hz	1.3	1.4	14	L001444
RE 420 S	100 V; 50/60 Hz	1.0	1.2	14	L001462	RE 1050 G	220 V; 60 Hz	2.4	2.9	3	L001416
RE 420 S	115 V; 60 Hz	1.3	1.4	14	L001434	RE 1225 S	100 V; 50/60 Hz	1.0	1.3	14	L001466
RE 420 S	220 V; 60 Hz	1.8	2.1	3	L001406	RE 1225 S	115 V; 60 Hz	1.3	1.4	14	L001438
RE 420 S	220 V; 60 Hz	1.8	2.1	2	L002074	RE 1225 S	220 V; 60 Hz	1.8	2.1	2	L002078
RE 420 G	100 V; 50/60 Hz	1.0	1.2	14	L001469	RE 1225 S	220 V; 60 Hz	1.8	2.1	3	L001410
RE 420 G	115 V; 60 Hz	1.3	1.4	14	L001441	RE 1225 G	100 V; 50/60 Hz	1.0	1.3	14	L001473
RE 420 G	220 V; 60 Hz	2.4	2.6	3	L001413	RE 1225 G	115 V; 60 Hz	1.3	1.4	14	L001445
RE 630 S	100 V; 50/60 Hz	1.0	1.3	14	L001464	RE 1225 G	220 V; 60 Hz	2.4	2.7	3	L001417
RE 630 S	115 V; 60 Hz	1.3	1.4	14	L001436	RE 2025 S	100 V; 50/60 Hz	1.0	1.3	14	L001467
RE 630 S	220 V; 60 Hz	1.8	2.1	3	L001408	RE 2025 S	115 V; 60 Hz	1.3	1.4	14	L001439
RE 630 S	220 V; 60 Hz	1.8	2.1	2	L002076	RE 2025 S	220 V; 60 Hz	1.8	2.1	2	L002079
RE 630 G	100 V; 50/60 Hz	1.0	1.3	14	L001471	RE 2025 S	220 V; 60 Hz	1.8	2.1	3	L001411
RE 630 G	115 V; 60 Hz	1.3	1.4	14	L001443	RE 2025 G	100 V; 50/60 Hz	1.0	1.3	14	L001474
RE 630 G	220 V; 60 Hz	2.4	2.7	2	L002083	RE 2025 G	115 V; 60 Hz	1.3	1.4	14	L001446
RE 630 G	220 V; 60 Hz	2.4	2.7	3	L001415	RE 2025 G	220 V; 60 Hz	2.4	2.7	3	L001418

*All data for the plug codes can be found on page 162

LAUDA Cooling thermostats

Power supply variants

Device type	Power supply V; Hz	Heater power max. kW	Loading max. kW	Plug code*	Part Number	Device type	Power supply V; Hz	Heater power max. kW	Loading max. kW	Plug code*	Part Number
LAUDA PRO / Page 64											
RP 2040	100 V; 50/60 Hz	1.3	1.6	32	L000538	RP 2045 C	200 V; 50/60 Hz	2.7	3.2	2	L000475
RP 2040	100 V; 50/60 Hz	1.3	1.5	14	L000530	RP 2045 C	200 V; 50/60 Hz	2.7	3.2	3	L000491
RP 2040	120 V; 60 Hz	1.9	1.9	32	L000458	RP 2045 C	200 V; 50/60 Hz	2.7	3.2	32	L000523
RP 2040	120 V; 60 Hz	1.9	1.9	4	L000450	RP 2045 C	200 V; 50/60 Hz	2.7	3.2	31	L000507
RP 2040	200 V; 50/60 Hz	2.7	3.2	31	L000498	RP 2045 C	208-220 V; 60 Hz	3.3	3.5	2	L000573
RP 2040	200 V; 50/60 Hz	2.7	3.2	32	L000514	RP 2045 C	208-220 V; 60 Hz	3.3	3.5	31	L000427
RP 2040	200 V; 50/60 Hz	2.7	3.2	3	L000482	RP 2045 C	208-220 V; 60 Hz	3.3	3.5	3	L000315
RP 2040	200 V; 50/60 Hz	2.7	3.2	2	L000466	RP 2045 C	208-220 V; 60 Hz	3.3	3.5	32	L000443
RP 2040	208-220 V; 60 Hz	3.3	3.5	32	L000434	RP 3035	100 V; 50/60 Hz	1.3	1.6	32	L000539
RP 2040	208-220 V; 60 Hz	3.3	3.5	2	L000564	RP 3035	100 V; 50/60 Hz	1.3	1.5	14	L000531
RP 2040	208-220 V; 60 Hz	3.3	3.5	31	L000418	RP 3035	120 V; 60 Hz	1.9	1.9	32	L000459
RP 2040	208-220 V; 60 Hz	3.3	3.5	3	L000306	RP 3035	120 V; 60 Hz	1.9	1.9	4	L000451
RP 2040 C	100 V; 50/60 Hz	1.3	1.5	14	L000534	RP 3035	200 V; 50/60 Hz	2.7	3.2	31	L000500
RP 2040 C	100 V; 50/60 Hz	1.3	1.6	32	L000542	RP 3035	200 V; 50/60 Hz	2.7	3.2	32	L000516
RP 2040 C	120 V; 60 Hz	1.9	1.9	32	L000462	RP 3035	200 V; 50/60 Hz	2.7	3.2	2	L000468
RP 2040 C	120 V; 60 Hz	1.9	1.9	4	L000454	RP 3035	200 V; 50/60 Hz	2.7	3.2	3	L000484
RP 2040 C	200 V; 50/60 Hz	2.7	3.2	3	L000490	RP 3035	208-220 V; 60 Hz	3.3	3.5	31	L000420
RP 2040 C	200 V; 50/60 Hz	2.7	3.2	31	L000506	RP 3035	208-220 V; 60 Hz	3.3	3.5	3	L000308
RP 2040 C	200 V; 50/60 Hz	2.7	3.2	32	L000522	RP 3035	208-220 V; 60 Hz	3.3	3.5	2	L000566
RP 2040 C	200 V; 50/60 Hz	2.7	3.2	2	L000474	RP 3035	208-220 V; 60 Hz	3.3	3.5	32	L000436
RP 2040 C	208-220 V; 60 Hz	3.3	3.5	3	L000314	RP 3035 C	100 V; 50/60 Hz	1.3	1.5	14	L000535
RP 2040 C	208-220 V; 60 Hz	3.3	3.5	32	L000442	RP 3035 C	100 V; 50/60 Hz	1.3	1.6	32	L000543
RP 2040 C	208-220 V; 60 Hz	3.3	3.5	31	L000426	RP 3035 C	120 V; 60 Hz	1.9	1.9	4	L000455
RP 2040 C	208-220 V; 60 Hz	3.3	3.5	2	L000572	RP 3035 C	120 V; 60 Hz	1.9	1.9	32	L000463
RP 2045	200 V; 50/60 Hz	2.7	3.2	31	L000499	RP 3035 C	200 V; 50/60 Hz	2.7	3.2	2	L000476
RP 2045	200 V; 50/60 Hz	2.7	3.2	3	L000483	RP 3035 C	200 V; 50/60 Hz	2.7	3.2	32	L000524
RP 2045	200 V; 50/60 Hz	2.7	3.2	2	L000467	RP 3035 C	200 V; 50/60 Hz	2.7	3.2	31	L000508
RP 2045	200 V; 50/60 Hz	2.7	3.2	32	L000515	RP 3035 C	200 V; 50/60 Hz	2.7	3.2	3	L000492
RP 2045	208-220 V; 60 Hz	3.3	3.5	2	L000565	RP 3035 C	208-220 V; 60 Hz	3.3	3.5	31	L000428
RP 2045	208-220 V; 60 Hz	3.3	3.5	31	L000419	RP 3035 C	208-220 V; 60 Hz	3.3	3.5	3	L000316
RP 2045	208-220 V; 60 Hz	3.3	3.5	32	L000435	RP 3035 C	208-220 V; 60 Hz	3.3	3.5	2	L000574
RP 2045	208-220 V; 60 Hz	3.3	3.5	3	L000307	RP 3035 C	208-220 V; 60 Hz	3.3	3.5	32	L000444

Device type	Power supply V; Hz	Heater power max. kW	Loading max. kW	Plug code*	Part Number	Device type	Power supply V; Hz	Heater power max. kW	Loading max. kW	Plug code*	Part Number
LAUDA PRO / Page 64											
RP 1090	200 V; 50/60 Hz	2.7	3.2	3	L000485	RP 2090 C	200 V; 50/60 Hz	2.7	3.2	2	L000478
RP 1090	200 V; 50/60 Hz	2.7	3.2	32	L000517	RP 2090 C	200 V; 50/60 Hz	2.7	3.2	3	L000494
RP 1090	200 V; 50/60 Hz	2.7	3.2	2	L000469	RP 2090 C	200 V; 50/60 Hz	2.7	3.2	32	L000526
RP 1090	200 V; 50/60 Hz	2.7	3.2	31	L000501	RP 2090 C	200 V; 50/60 Hz	2.7	3.2	31	L000510
RP 1090	208-220 V; 60 Hz	3.3	3.5	32	L000437	RP 2090 C	208-220 V; 60 Hz	3.3	3.5	3	L000318
RP 1090	208-220 V; 60 Hz	3.3	3.5	3	L000309	RP 2090 C	208-220 V; 60 Hz	3.3	3.5	32	L000446
RP 1090	208-220 V; 60 Hz	3.3	3.5	2	L000567	RP 2090 C	208-220 V; 60 Hz	3.3	3.5	31	L000430
RP 1090	208-220 V; 60 Hz	3.3	3.5	31	L000421	RP 2090 C	208-220 V; 60 Hz	3.3	3.5	2	L000576
RP 1090 C	200 V; 50/60 Hz	2.7	3.2	32	L000525	RP 10100	200 V; 50/60 Hz	2.7	3.2	32	L000519
RP 1090 C	200 V; 50/60 Hz	2.7	3.2	2	L000477	RP 10100	200 V; 50/60 Hz	2.7	3.2	31	L000503
RP 1090 C	200 V; 50/60 Hz	2.7	3.2	31	L000509	RP 10100	200 V; 50/60 Hz	2.7	3.2	2	L000471
RP 1090 C	200 V; 50/60 Hz	2.7	3.2	3	L000493	RP 10100	200 V; 50/60 Hz	2.7	3.2	3	L000487
RP 1090 C	208-220 V; 60 Hz	3.3	3.5	31	L000429	RP 10100	208-220 V; 60 Hz	3.3	3.5	32	L000439
RP 1090 C	208-220 V; 60 Hz	3.3	3.5	2	L000575	RP 10100	208-220 V; 60 Hz	3.3	3.5	31	L000423
RP 1090 C	208-220 V; 60 Hz	3.3	3.5	32	L000445	RP 10100	208-220 V; 60 Hz	3.3	3.5	2	L000569
RP 1090 C	208-220 V; 60 Hz	3.3	3.5	3	L000317	RP 10100	208-220 V; 60 Hz	3.3	3.5	3	L000311
RP 2090	200 V; 50/60 Hz	2.7	3.2	2	L000470	RP 10100 C	200 V; 50/60 Hz	2.7	3.2	32	L000527
RP 2090	200 V; 50/60 Hz	2.7	3.2	32	L000518	RP 10100 C	200 V; 50/60 Hz	2.7	3.2	31	L000511
RP 2090	200 V; 50/60 Hz	2.7	3.2	31	L000502	RP 10100 C	200 V; 50/60 Hz	2.7	3.2	3	L000495
RP 2090	200 V; 50/60 Hz	2.7	3.2	3	L000486	RP 10100 C	200 V; 50/60 Hz	2.7	3.2	2	L000479
RP 2090	208-220 V; 60 Hz	3.3	3.5	32	L000438	RP 10100 C	208-220 V; 60 Hz	3.3	3.5	3	L000319
RP 2090	208-220 V; 60 Hz	3.3	3.5	2	L000568	RP 10100 C	208-220 V; 60 Hz	3.3	3.5	31	L000431
RP 2090	208-220 V; 60 Hz	3.3	3.5	3	L000310	RP 10100 C	208-220 V; 60 Hz	3.3	3.5	32	L000447
RP 2090	208-220 V; 60 Hz	3.3	3.5	31	L000422	RP 10100 C	208-220 V; 60 Hz	3.3	3.5	2	L000577
LAUDA Proline Kryomats / Page 66											
RP 4050 C	200 V; 3/PE; 50/60 Hz	2.8	5.0	31	L001701	RP 4090 C	200 V; 3/PE; 50/60 Hz	2.8	7.0	31	L001703
RP 4050 C	208 V; 3/PE; 60 Hz	3.0	5.0	31	L001677	RP 4090 C	208 V; 3/PE; 60 Hz	3.0	7.0	31	L001679
RP 4050 CW	200 V; 3/PE; 50/60 Hz	2.8	5.0	31	L001705	RP 4090 CW	200 V; 3/PE; 50/60 Hz	2.8	7.0	31	L001707
RP 4050 CW	208 V; 3/PE; 60 Hz	3.0	5.0	31	L001681	RP 4090 CW	208 V; 3/PE; 60 Hz	3.0	7.0	31	L001683

*All data for the plug codes can be found on page 162. All device types with mark >W< are water-cooled

LAUDA Cooling thermostats

More characteristics

LAUDA Alpha / Page 60

PUMP CHARACTERISTIC Water

Pressure bar

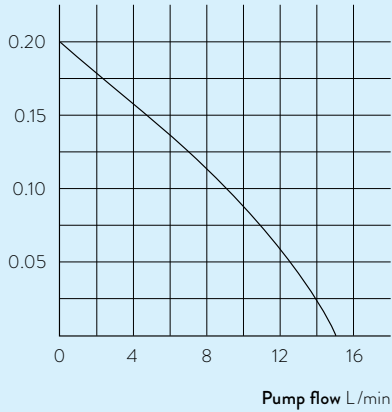

LAUDA ECO / Page 62

COOLING PERFORMANCE According to DIN 12876

Bath temperature °C

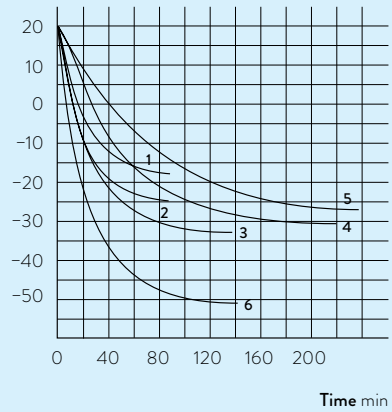

- 1 RE 415 S
- 2 RE 420 S
- 3 RE 630 S
- 4 RE 1225 S
- 5 RE 2025 S
- 6 RE 1050 S

PUMP CHARACTERISTIC Water

Pressure bar

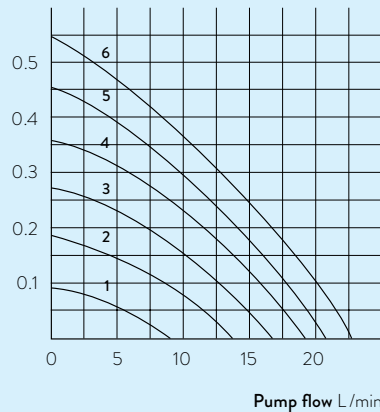

- 1 Step 1
- 2 Step 2
- 3 Step 3
- 4 Step 4
- 5 Step 5
- 6 Step 6

LAUDA Proline Kryomats / Page 66

COOLING PERFORMANCE According to DIN 12876

Bath temperature °C

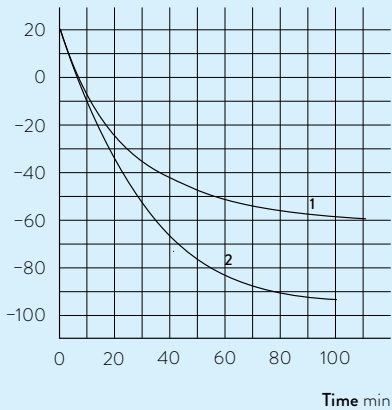

- 1 RP 4050 CW
- 2 RP 4090 CW

LAUDA CIRCULATION AND PROCESS THERMOSTATS

°LAUDA

Specific application examples

- Refractometer
- Polarimeter
- Single-use bioreactors
- Extruder for food production
- Micro reactors
- Responsive control in chemical/pharmaceutical surroundings
- Climate chambers
- Space simulation
- Electric mobility; battery testing
- Test rigs
- Stress test
- Crystallization regulation
- Freeze-drying
- Micro structures
- Coating plants



°LAUDA

Tset -5,00 °C

Tint 19,42

Einstellungen
Stufe 4
Messung 6



LAUDA LOOP

The compact, lightweight circulation thermostat for external applications from 4 to 80 °C

4°C  80°C

Extremely versatile, flexibly usable thermo-electric circulation thermostat

The LAUDA LOOP circulation thermostat is sure to impress with its constant temperature range between 4 and 80 °C. Its compact construction and low weight, as well as wide voltage input range of 100 to 240 volts, make it possible to put it to use flexibly and spontaneously anywhere in the world – the ›Plug and Play‹ setup with quick-fit couplings makes it especially easy to use. The intuitive three-button softkey operation and simple menu navigation in five available languages via the well-lit, high-contrast OLED display make using the device a breeze.



Simple three-button controls with OLED display



Standard-issue RS 232 interface for system integration into processes

PUMP CHARACTERISTIC Water

Pressure bar

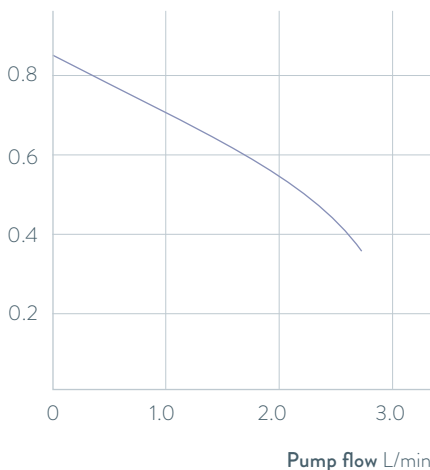

Important functions

- Pump connections with quick-fit couplings for easy consumer changes
- Can be operated with non-flammable liquids (water, water/glycol)
- Cooling technology free of coolant ensures silent, low-vibration operation

Included accessories

Hose nozzles for pump connections

Further accessories

Tubing

All technical data and power supply variants can be found in the ›Technical data‹ section.

More at www.lauda.de/1748



LAUDA LOOP

The L100 and L250 air-cooled device types achieve a cooling capacity of 120 and 250 watt. The devices are primarily for use at constant temperatures with low power requirements. Both device types are especially energy-efficient and silent in partial-load operation.



LAUDA PRO

Compact circulation thermostats for professional temperature control from -90 to 250 °C



Flexible operation, outstanding performance characteristics

LAUDA PRO is the cutting-edge product line with an outstanding overall concept: The circulation thermostats with small, active volumes of liquid enable rapid temperature changes in external applications. The innovative Base or Command Touch operating units can be detached and used as a remote control. The cooling thermostats come equipped with hybrid cooling as standard, which allows for additional cooling of the refrigerating machine with water.



Many basic functions with the economic Base variant

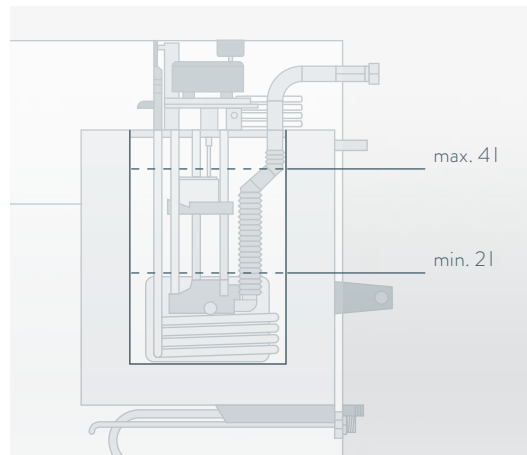

The small filling volume and powerful vario flex pump offer fast temperature changes with low operating costs and material consumption

PUMP CHARACTERISTICS Water

Pressure bar

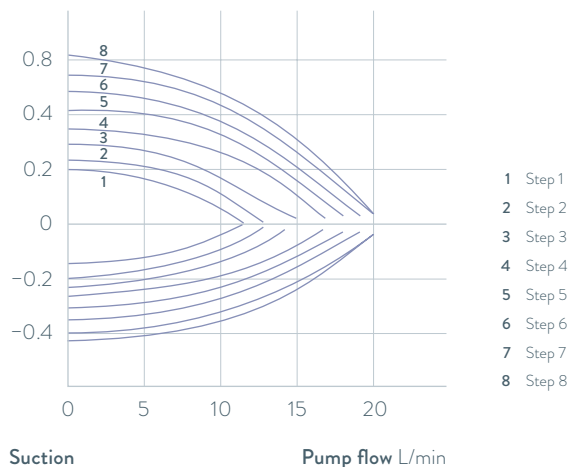

Suction

Pump flow L/min

Important functions

- Tower design for small footprint
- LAUDA Vario Flex Pump with 8 available output levels, pump connections at rear
- SmartCool system for digital, energy-saving cooling control including automatic compressor control

Included accessories

Tubing nipples for pumps and cooling water connection

Further accessories

Tubing, interface modules

All technical data and power supply variants can be found in the ›Technical data‹ section.

More at www.lauda.de/1750



LAUDA PRO

The PRO heating circulation thermostats are designed for external applications up to 250 °C. The compact construction permits space-saving installation of the thermostats. An integrated cooling coil, fitted as standard, provides cooling. The PRO cooling circulation thermostats are ideal for external applications where rapid temperature changes are required. The cooling output of 0.6 and 0.8 kW or 1.5 kW, combined with a very low filling volume permit these rapid temperature changes.



LAUDA Integral T

Process thermostats for professional external temperature control in the temperature range of -30 to 150 °C



LAUDA Integral T process thermostats are optimally suited to the effective monitoring of external temperature control processes in temperatures ranging from -30 to 150 °C. Integral T process thermostats enable fast temperature changes thanks to tailored heating outputs and cooling capacities with small internal volumes.

The open hydraulic system means that the device vents quickly without any impairment of function, and is thus ideal for temperature controlling processes with frequent changes of consumer or user.

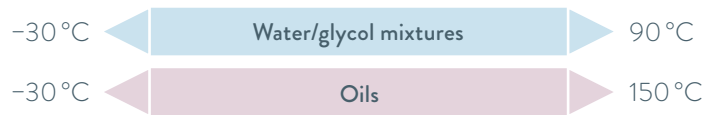

Three different housing sizes, depending on the output power



Ethernet, USB, malfunction contact and Pt100 as standard, two module slots for additional interfaces

INTEGRAL T HYDRAULIC DIAGRAM

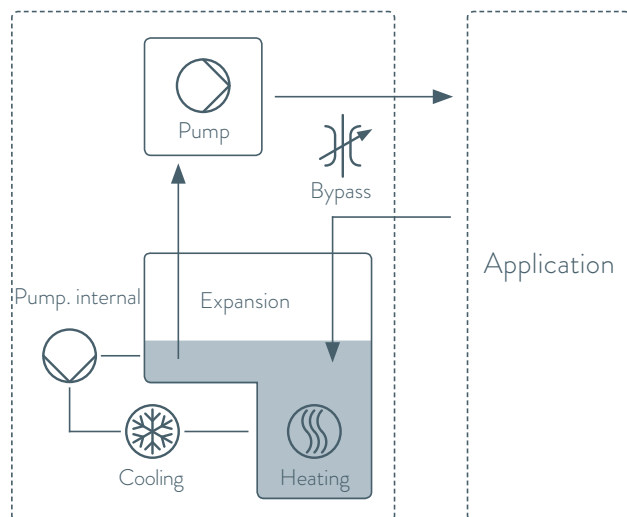

Important functions

- Compact, open bath system with large expansion volume
- Programmer with 150 temperature/time segments
- Self-adaption of the controller for optimized temperature control
- Adjustable bypass for pressure limitation
- Filling from above, drainage from the side
- Electronic level monitoring
- Operation in internal LAN possible on web server via PC or tablet/smartphone
- Remote monitoring and maintenance via LAUDA.LIVE

Included accessories

Nipples for pump connections

Further accessories

Tubing, 4-port manifold

All technical data and power supply variants can be found in the ›Technical data‹ section.

More at www.lauda.de/1752



LAUDA Integral T

The bypass in the Integral T reduces the linear pump characteristics when it opens. Pressure-sensitive applications can therefore be protected by reducing the discharge pressure. The digital pressure indication in the Integral T display facilitates manual adjustment of the discharge pressure by means of a bypass. The robust and powerful immersion pressure pump ensures reliable, leak-free and safe operation. The independent internal circulation of the heat transfer liquid ensures maximum heating and cooling capacity.



LAUDA Integral XT

High-performance process thermostats from 1.5 to 25 kW for temperature control from -90 to 320 °C



LAUDA Integral XT process thermostats operate according to the flow principle with a cold oil overlay which enables the utilization of temperature control media over a significantly larger temperature range—optimal for dynamic temperature control tasks.

The electronically controlled, magnetically coupled pump can set the flow rate optimally both for the requirements of pressure-sensitive consumers and for applications with high hydraulic resistance.



TFT display with different screens or temperature profiles



Bypass included as standard. For increased internal flow rates in applications requiring pressure limitations

INTEGRAL XT HYDRAULIC DIAGRAM

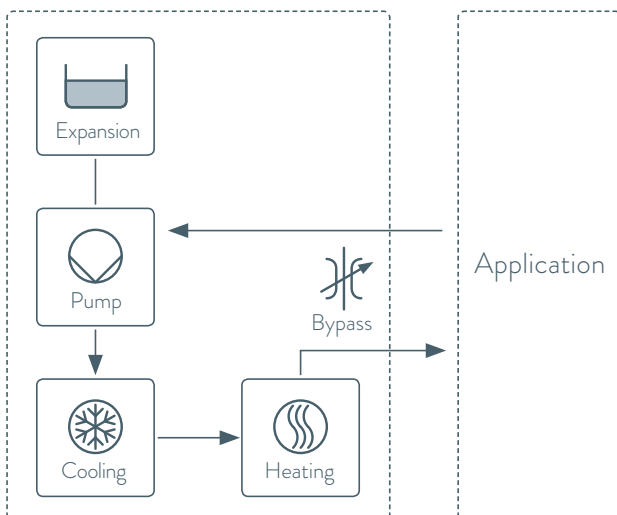

Important functions

- High-performance LAUDA Vario Pump (pressure pump) with 8 selectable output levels or flow pressure control
- Programmer with 150 temperature/time segments, can be divided into five programs
- Two additional interface modules available for retrofit
- Operation in internal LAN possible on web server via PC or tablet/smartphone
- Remote monitoring and maintenance via LAUDA.LIVE

Standard equipment

Ethernet and USB interfaces, Pt-100 and malfunction contact

Additional accessories

Hoses, adapters, through-flow control systems

All technical data and power supply variants can be found in the ›Technical data‹ section.

More at www.lauda.de/1754



LAUDA Integral XT

The Integral XT uses an eight-stage, robust and magnetically coupled Vario pump with selectable characteristics to ensure a reliable supply to the consumer, even with high flow resistance. The menu-driven selection of the pump level enables optimum thermal connection of the application with the required pressure and volume flow rate.

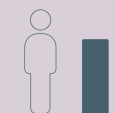

LAUDA Integral P

High-performance process thermostats from 20 to 25 kW for temperature control from -40 to 140 °C



The new **LAUDA Integral P** process thermostats function according to the flow principle, with a pressure overlay of up to 4 bar. This allows non-flammable water/glycol mixtures to be used in a temperature range of -40 to 140 °C.

Thanks to the electronically controlled, magnetically coupled pump, optimized flow rates can be set for different applications.

-40 °C ◀ Water/glycol mixtures ▶ 140 °C

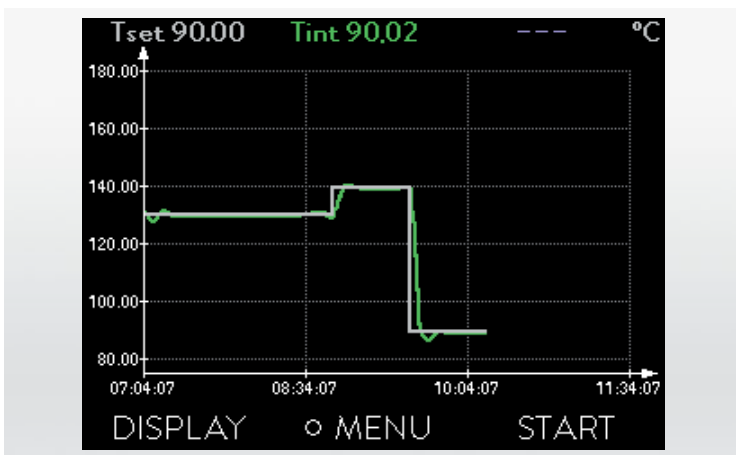

TFT display with different screens or temperature profiles



Bypass included as standard. For increased internal flow rates in applications requiring pressure limitations

INTEGRAL P HYDRAULIC DIAGRAM

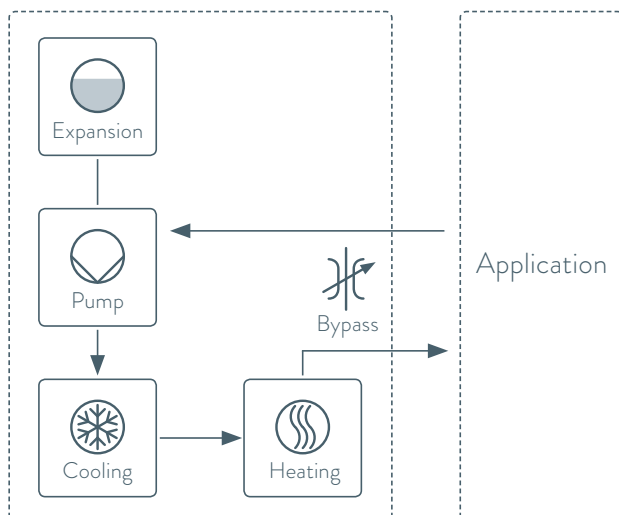

Important functions

- High-performance LAUDA Vario Pump (pressure pump) with 8 selectable output levels or flow pressure control
- Programmer with 150 temperature/time segments, can be divided into five programs
- Two additional interface modules available for retrofit
- Operation in internal LAN possible on web server via PC or tablet/smartphone
- Venturi element for vacuum filling
- Remote monitoring and maintenance via LAUDA.LIVE

Standard equipment

Ethernet and USB interfaces, Pt-100 and malfunction contact

Additional accessories

Hoses, adapters, through-flow control systems

All technical data and power supply variants can be found in the ›Technical data‹ section.

More at www.lauda.de/1754

NEW

LAUDA.LIVE
ready



LAUDA Integral P

The new LAUDA Integral P process thermostats function according to the flow principle, with a pressure overlay of up to 4 bar. This allows non-flammable water/glycol mixtures to be used in a temperature range of -40 to 140 °C. Thanks to the electronically controlled, magnetically coupled pump, optimized flow rates can be set for different applications.



Circulation and process thermostats

Circulation chillers

Calibration thermostats

Deep-freezers

Shakers

Stills

Accessories

LAUDA Variocool

Process thermostats from -20 to 80 °C
with cooling capacities up to 10 kW and powerful pumps



Powerful and flexible in use

A comprehensive performance spectrum enables the LAUDA Variocool to deal with sophisticated process temperature control in the moderate temperature range. Equipment incorporating various pumps and individual expansion with interface modules, including the option of external temperature control, allow optimized adaptation to changing requirements in the process environment.



Malfunction contact included as standard. A Pt100 module for external temperature control and interfaces for analog and digital communication can also be added.



Analog pressure indication for operational control, can be adjusted via the bypass on the back of the device

PUMP CHARACTERISTIC Water

Pressure bar

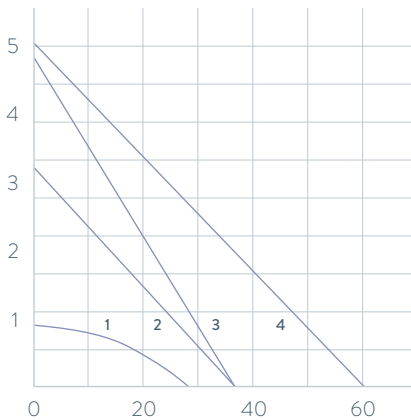

- 1 0,9 bar, 28 L/min
- 2 3,2 bar, 37 L/min
- 3 4,8 bar, 37 L/min
- 4 5,0 bar, 60 L/min

Pump flow L/min

Important functions

- Adjustable bypass for pressure limitation
- Filling opening at the top, drain tap at the rear
- Integrated programmer with 150 segments, can be divided into 5 programs
- Electronic level indicator and low-level alarm
- SmartCool system for digital, energy-saving cooling control, including automatic compressor control

Included accessories

Nipples, screw caps

Further accessories

Hoses, interface modules

All technical data and power supply variants can be found in the ›Technical data‹ section.

More at www.lauda.de/1756



LAUDA Variocool

All models are available in air and water-cooled versions (W) and fitted with moveable as well as fixable castors. High-performance process thermostats in a tower design starting from the VC 5000 model are available with sound insulation.



LAUDA Semistat

Thermo-electric process thermostats
for the semiconductor industry from -20 to 90°C



Fast and precise temperature control for demanding processes

The thermoelectric Semistat temperature control system offers reproducible temperature control for plasma etching applications. This system dynamically controls the temperature of the electrostatic wafer chuck (ESC) and can be used in all types of etching processes. The LAUDA Semistat thermoelectric temperature control systems are based on established principles of heat transfer used for Peltier elements. These elements allow quick and precise temperature control required for complex processes involved in the manufacture of components progressively getting smaller and smaller in size.



The Power Supply Controller (PSC) meets industry-specific SEMI S2 and F47 standards

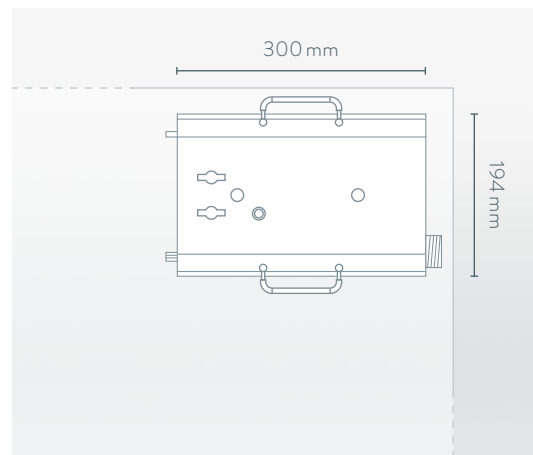

Small footprint

COOLING POWER dependent on process temperature and flow rate of cooling water

Effective cooling power kW

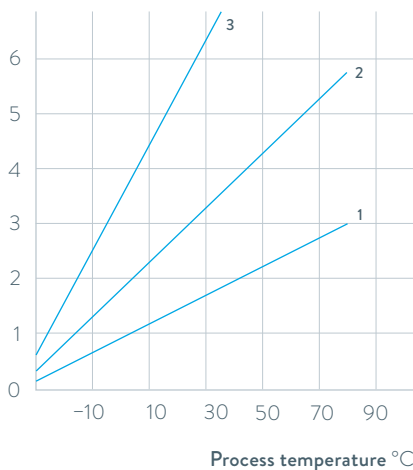

3 S 4400
2 S 2400
1 S 1200

Important functions

- Compressor and refrigerant-free system with low energy consumption
- Smallest footprint in the industry, ideally suited for underfloor installation
- Extremely low volume of heat transfer fluid

Available accessories

Communications modules with remote control function (RS-485 protocol)

All technical data and power supply variants can be found in the ›Technical data‹ section.

More at www.lauda.de/1760



LAUDA Semistat

Semistat temperature control systems can reduce energy consumption by up to 90% compared to compressor-based systems.

Minimal space requirements with the option of underfloor installation at the point of use minimizes cleanroom use.



LAUDA Circulation and process thermostats

Device type overview

LAUDA LOOP / Page 84

LAUDA PRO / Page 86

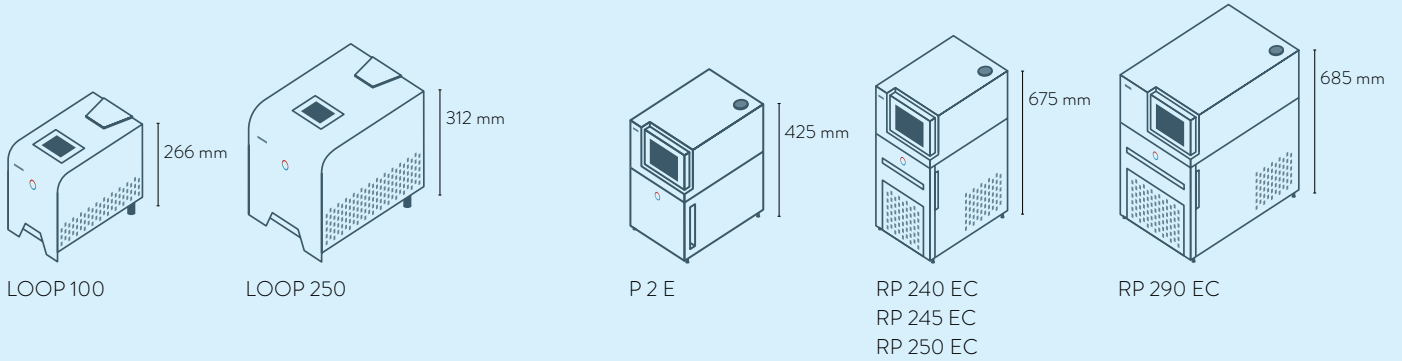

LAUDA Integral T / Page 88

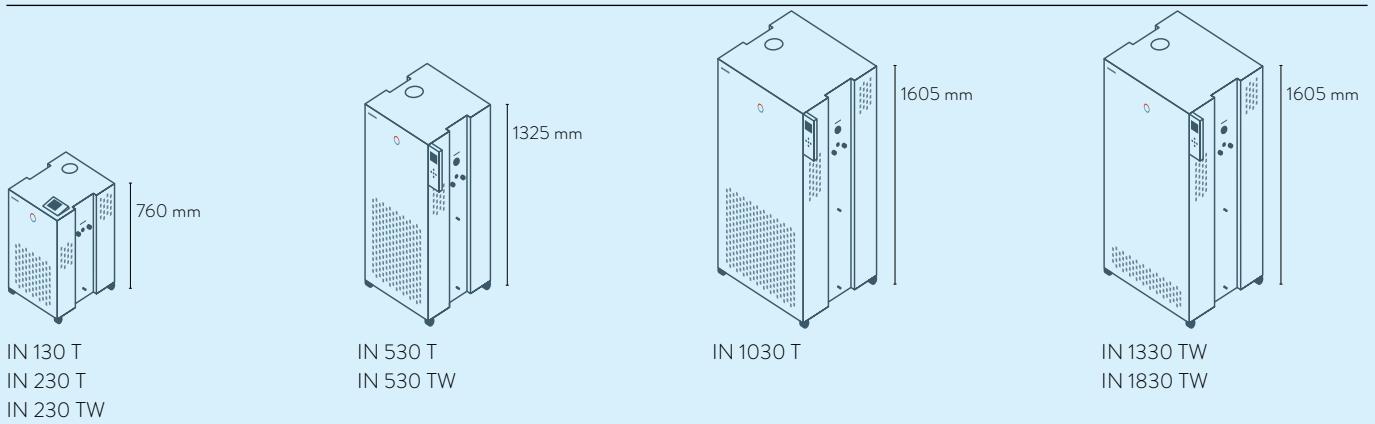

LAUDA Integral XT / Page 90

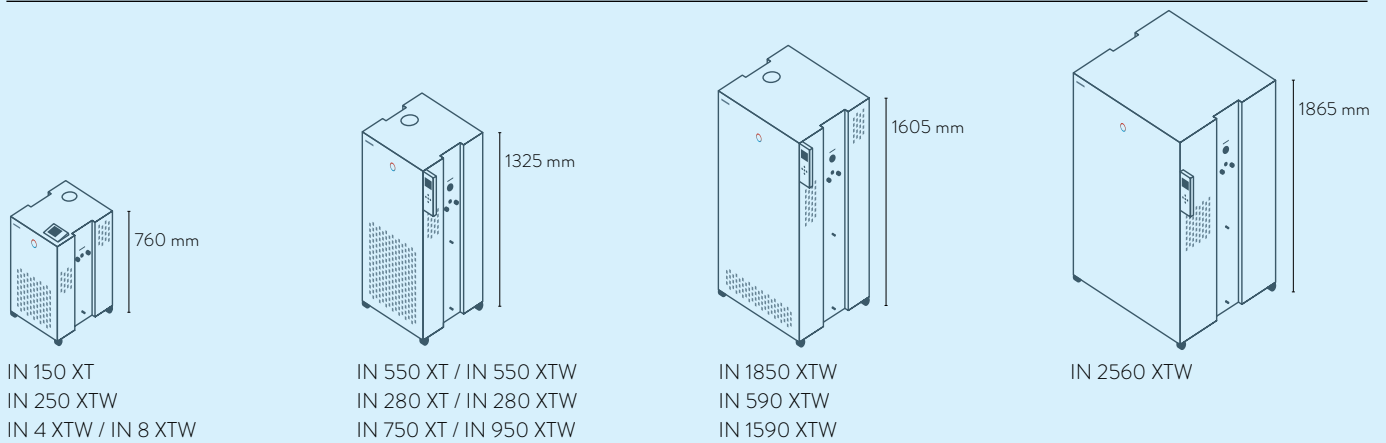

LAUDA Integral P / Page 92

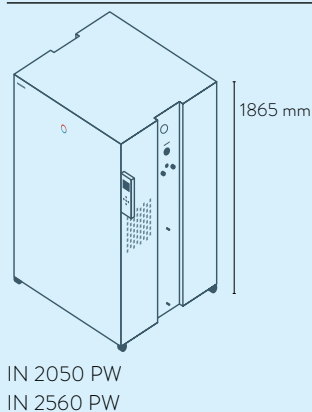

IN 2050 PW
IN 2560 PW

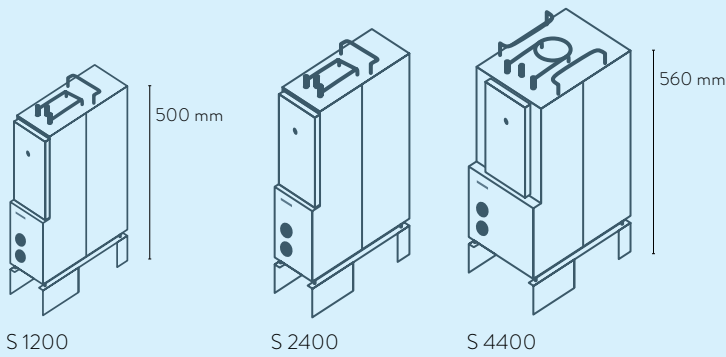
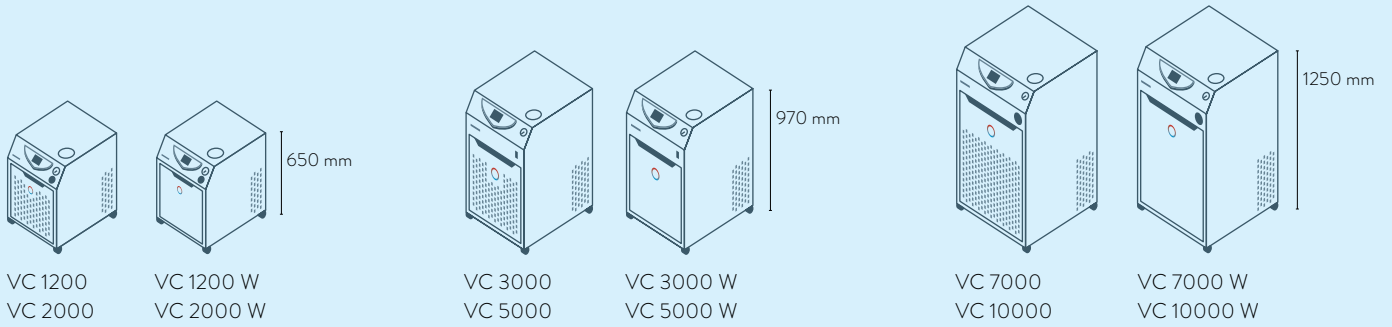

LAUDA Circulation and process thermostats

Interfaces

	Pt 100 (1)	Pt 100 (2)	USB	Ethernet	RS 232 / 485	Analog	Namur contact	D-Sub contact	PROFIBUS	EtherCAT M8	EtherCAT RJ 45	Malfunction contact	Number of module slots, large	Number of module slots, small	RS232/485 module Advanced	Contact module NAMUR Advanced	Contact module D-Sub Advanced	Profibus module Advanced	Ethernet module Advanced	Profinet module Advanced	CAN module Advanced
LAUDA LOOP / Page 84	-	-	-	-	S	-	-	-	-	-	-	-	-	-	-	-	-	-	-	-	-
LAUDA PRO / Page 86	S	-	S	S	Z	Z	Z	Z	Z	Z	Z	-	1	-	Z	Z	Z	Z	-	Z	Z
LAUDA Integral T / Page 88	S	Z	S	S	Z	Z	Z	Z	Z	Z	Z	S	2	-	Z	Z	Z	Z	S	Z	Z
LAUDA Integral XT / Page 90	S	Z	S	S	Z	Z	Z	Z	Z	Z	Z	S	2	-	Z	Z	Z	Z	S	Z	Z
LAUDA Integral P / Page 92	S	Z	S	S	Z	Z	Z	Z	Z	Z	Z	S	2	-	Z	Z	Z	Z	S	Z	Z
LAUDA Variocool / Page 94	Z	-	S	Z	Z	Z	Z	Z	Z	Z	Z	S	1	1	Z	Z	Z	Z	Z	Z	Z

S = Series standard

Z = Available as an accessory

LAUDA interfaces



LRZ 912
Analog module



LRZ 913
RS 232/485 interface



LRZ 914
Contact module, 1 input, 1 output (NAMUR)



LRZ 915
Contact module, 3 inputs, 3 outputs



LRZ 917
Profibus module

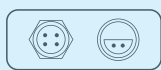

LRZ 918
Pt100/LiBus-Modul, small cover



LRZ 921
Ethernet module

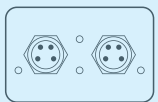

LRZ 922
EtherCAT module with M8 connection

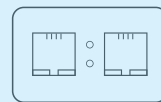

LRZ 923
EtherCAT module with RJ45 connection



LRZ 925
External Pt100/LiBus-module, large cover

LAUDA interfaces Advanced* (Modules available as accessories from Q3 / 2022)



LRZ 926
RS232/485 module Advanced, D-Sub 9-pin



LRZ 927
Contact module NAMUR Advanced, 1 input, 1 output



LRZ 928
Contact module D-Sub Advanced, 3 inputs, 3 outputs



LRZ 929
Profibus module Advanced, D-Sub 9-pin

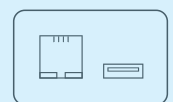

LRZ 930
Ethernet module Advanced, RJ45

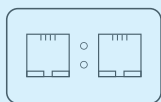

LRZ 932
Profinet module Advanced, RJ45



LRZ 933
CAN module Advanced, D-Sub 9-pin

* Interfaces of the Advanced generation replace modules in the process thermostats of the same name as per the above selection table

LAUDA Circulation and process thermostats

Function overview

Operating element	Circulation thermostats		Process thermostats		Calibration thermostats		Deep-freezers	
	LOOP	PROE	PROEC	Integral T	Integral XT	Integral P	Integral P	Variocool
Display	OLED	OLED	TFT	TFT	TFT	TFT	TFT	TFT
Mode of operation	3-button softkey	Cursor softkey	Multi-touch	Cursor softkey	Cursor softkey	Cursor softkey	Cursor softkey	Cursor softkey
Removable control	-	✓	✓	Z	Z	Z	Z	-
User management	-	-	✓	Operator / Viewer	Operator / Viewer	Operator / Viewer	Operator / Viewer	-
Data logging, export to USB stick	-	-	✓	✓	✓	✓	✓	-
1-point calibration	✓	✓	✓	✓	✓	✓	✓	✓
2-point calibration	✓	✓	✓	✓	✓	✓	✓	-
Self-adaptation controller	-	-	✓	✓	✓	✓	✓	-
Safety mode	-	✓	✓	✓	✓	✓	✓	-
Programmer, programs/segments	-	1 / 20	100 / 5000	5 / 146	5 / 146	5 / 146	5 / 146	5 / 146
Programmer, tolerance range function	-	✓	✓	✓	✓	✓	✓	✓
Ramp function	-	-	✓	Z	Z	Z	Z	-
Timer function	-	-	✓	✓	✓	✓	✓	-
Countdown function	-	-	✓	-	-	-	-	-
Graphic temperature profile display	-	-	✓	✓	✓	✓	✓	✓
Pump pressure display (digital)	-	-	-	✓	✓	✓	✓	-
Adjustable bypass	-	-	-	✓	✓	✓	✓	✓
Level indicator (digital)	-	✓	✓	✓	✓	✓	✓	✓
Standby timer	✓	✓	✓	✓	✓	✓	✓	✓
Flow control instrument	-	-	-	-	-	-	-	Z
Flow pressure control	-	-	-	-	✓	✓	✓	-
Flow measurement + control	-	-	-	-	Z	Z	Z	-
Overflow	-	✓	✓	✓	✓	✓	✓	-
Low-level alarm	✓	✓	✓	✓	✓	✓	✓	✓
Drain tap	-	✓	✓	✓	✓	✓	✓	✓

Z = Available as an accessory

LAUDA Circulation and process thermostats

Technical data according to DIN 12876 standard

Device type	Working temperature range °C	Temperature stability ±K	Cooling of the refrigerating machine	Heater power max. kW	Cooling output kW													
					200 °C	100 °C	20 °C	10 °C	0 °C	-10 °C	-20 °C	-30 °C	-40 °C	-50 °C	-60 °C	-70 °C	-80 °C	-90 °C

LAUDA LOOP / Page 84

LOOP 100	4 ... 80	0.10	Air	0.2	-	-	0.12	0.06	-	-	-	-	-	-	-	-	-	-
LOOP 250	4 ... 80	0.10	Air	0.4	-	-	0.25	0.13	-	-	-	-	-	-	-	-	-	-

LAUDA PRO / Page 86

P 2 E	80 ... 250	0.05	Water	2.5	-	-	-	-	-	-	-	-	-	-	-	-	-	-
P 2 EC	80 ... 250	0.05	Water	2.5	-	-	-	-	-	-	-	-	-	-	-	-	-	-
RP 240 E	-40 ... 200	0.05	Hybrid	2.5	-	-	0.60 ³	0.60 ³	0.60 ³	0.41 ³	0.24 ²	0.12 ²	0.02 ¹	-	-	-	-	-
RP 240 EC	-40 ... 200	0.05	Hybrid	2.5	-	-	0.60 ³	0.60 ³	0.60 ³	0.41 ³	0.24 ²	0.12 ²	0.02 ¹	-	-	-	-	-
RP 245 E	-45 ... 200	0.05	Hybrid	2.5	-	-	0.80 ³	0.80 ³	0.80 ³	0.53 ³	0.34 ²	0.15 ²	0.04 ²	-	-	-	-	-
RP 245 EC	-45 ... 200	0.05	Hybrid	2.5	-	-	0.80 ³	0.80 ³	0.80 ³	0.53 ³	0.34 ²	0.15 ²	0.04 ²	-	-	-	-	-
RP 250 E	-50 ... 200	0.05	Hybrid	2.5	-	-	1.50 ³	1.44 ³	1.20 ³	0.84 ³	0.54 ²	0.29 ²	0.11 ²	0.02 ¹	-	-	-	-
RP 250 EC	-50 ... 200	0.05	Hybrid	2.5	-	-	1.50 ³	1.44 ³	1.20 ³	0.84 ³	0.54 ²	0.29 ²	0.11 ²	0.02 ¹	-	-	-	-
RP 290 E	-90 ... 200	0.05	Hybrid	2.5	-	-	0.80 ³	0.77 ³	0.74 ³	0.72 ³	0.70 ²	0.68 ²	0.64 ²	0.56 ²	0.39 ²	0.21 ²	0.09 ²	0.01 ¹
RP 290 EC	-90 ... 200	0.05	Hybrid	2.5	-	-	0.80 ³	0.77 ³	0.74 ³	0.72 ³	0.70 ²	0.68 ²	0.64 ²	0.56 ²	0.39 ²	0.21 ²	0.09 ²	0.01 ¹

LAUDA Integral T / Page 88

IN 130 T	-30 ... 120	0.05	Air	2.7	-	1.40	1.40	1.35	1.20	0.80	0.40	0.10	-	-	-	-	-	-
IN 230 T	-30 ... 120	0.05	Air	2.7	-	2.20	2.20	1.90	1.50	1.00	0.60	0.15	-	-	-	-	-	-
IN 230 TW	-30 ... 120	0.05	Water	2.7	-	2.30	2.30	2.30	1.90	1.30	0.75	0.35	-	-	-	-	-	-
IN 530 T	-30 ... 120	0.05	Air	8.0	-	5.00	5.00	4.50	3.80	2.60	1.50	0.60	-	-	-	-	-	-
IN 530 TW	-30 ... 120	0.05	Water	8.0	-	6.00	6.00	5.50	4.50	3.00	1.60	0.70	-	-	-	-	-	-
IN 1030 T	-30 ... 150	0.10	Air	8.0	-	11.00	11.00	9.50	7.10	4.90	3.00	1.60	-	-	-	-	-	-
IN 1330 TW	-30 ... 150	0.10	Water	16.0	-	13.00	13.00	10.00	7.60	5.40	3.40	1.70	-	-	-	-	-	-
IN 1830 TW	-30 ... 150	0.10	Water	16.0	-	19.00	19.00	15.00	11.50	7.50	5.00	2.70	-	-	-	-	-	-

¹Pump output step 2 ²Pump output step 4 ³Pump output step 8

Pump pressure max. bar	Pump flow max. pressure L/min	Pump connection thread mm	Bath volume min. L	Bath volume max. L	Dimensions (W x D x H) mm	Protection Rating	Noise level dB (A)	Weight kg	Loading max. kW	Power supply V; Hz	Part Number	Device type
0.8	2.6	Quick C. 1/4"	0.26	0.28	175×301×266	IP 21	57	7	0.2	100-240 V; 50/60 Hz	L000027	LOOP 100
0.8	2.6	Quick C. 1/4"	0.30	0.32	261×368×312	IP 21	57	12	0.4	100-240 V; 50/60 Hz	L000580	LOOP 250
0.68	22	M16×1	2.4	4.4	250×365×425	IP 21	47	16.5	2.7	200-230 V; 50/60 Hz	L000019	P 2 E
0.68	22	M16×1	2.4	4.4	250×365×425	IP 21	47	17.0	2.7	200-230 V; 50/60 Hz	L000020	P 2 EC
0.68	22	M16×1	2.4	4.4	300×430×675	IP 21	54	41.5	3.7	230 V; 50 Hz	L000021	RP 240 E
0.68	22	M16×1	2.4	4.4	300×430×675	IP 21	54	41.5	3.7	230 V; 50 Hz	L000023	RP 240 EC
0.68	22	M16×1	2.4	4.4	300×430×675	IP 21	54	38.5	3.7	230 V; 50 Hz	L000022	RP 245 E
0.68	22	M16×1	2.4	4.4	300×430×675	IP 21	54	40.0	3.7	230 V; 50 Hz	L000024	RP 245 EC
0.68	22	M16×1	2.4	4.4	300×430×675	IP 21	57	46.5	3.7	230 V; 50 Hz	L002494	RP 250 E
0.68	22	M16×1	2.4	4.4	300×430×675	IP 21	57	47.5	3.7	230 V; 50 Hz	L002495	RP 250 EC
0.68	22	M16×1	2.4	4.4	390×600×685	IP 21	56	76.5	3.7	230 V; 50 Hz	L002502	RP 290 E
0.68	22	M16×1	2.4	4.4	390×600×685	IP 21	56	78.5	3.7	230 V; 50 Hz	L002503	RP 290 EC
3.5	40	G 3/4	3.6	8.7	430×550×760	IP 21	61	79	3.7	230 V; 50 Hz	L002663	IN 130 T
3.5	40	G 3/4	3.6	8.7	430×550×760	IP 21	63	84	3.7	230 V; 50 Hz	L002664	IN 230 T
3.5	40	G 3/4	3.6	8.7	430×550×760	IP 21	60	85	3.7	230 V; 50 Hz	L002665	IN 230 TW
3.5	40	G 3/4	7.2	20.5	560×550×1325	IP 21	66	149	11.0	400 V; 3/PE; 50 Hz & 460 V; 3/PE; 60 Hz	L002666	IN 530 T
3.5	40	G 3/4	7.2	20.5	560×550×1325	IP 21	62	150	11.0	400 V; 3/PE; 50 Hz & 460 V; 3/PE; 60 Hz	L002667	IN 530 TW
5.5	60	M38×1.5	9.7	25.5	760×650×1605	IP 21	70	223	11.0	400 V; 3/PE; 50 Hz & 460 V; 3/PE; 60 Hz	L002668	IN 1030 T
5.5	60	M38×1.5	9.7	25.5	760×650×1605	IP 21	62	225	18.0	400 V; 3/PE; 50 Hz & 460 V; 3/PE; 60 Hz	L002669	IN 1330 TW
5.5	60	M38×1.5	9.7	25.5	760×650×1605	IP 21	67	244	18.0	400 V; 3/PE; 50 Hz & 460 V; 3/PE; 60 Hz	L002670	IN 1830 TW

LAUDA Circulation and process thermostats

Technical data according to DIN 12876 standard

Device type	Working temperature range °C	Temperature stability ±K	Cooling of the refrigerating machine	Heater power max. kW	Cooling output kW													
					200 °C	100 °C	20 °C	10 °C	0 °C	-10 °C	-20 °C	-30 °C	-40 °C	-50 °C	-60 °C	-70 °C	-80 °C	-90 °C
LAUDA Integral XT / Page 90																		
IN 150 XT	-45 ... 220	0.05	Air	3.5	1.50 ³	1.50 ³	1.50 ³	1.50 ³	1.30 ³	1.00 ³	0.70 ²	0.30 ²	0.06 ²	-	-	-	-	-
IN 250 XTW	-45 ... 220	0.05	Water	3.5	2.20 ³	2.20 ³	2.10 ³	2.00 ³	1.80 ³	1.40 ³	1.00 ²	0.55 ²	0.20 ²	-	-	-	-	-
IN 550 XT	-50 ... 220	0.05	Air	8.0	5.00 ³	5.00 ³	5.00 ³	4.80 ³	4.60 ³	3.30 ³	2.30 ²	1.20 ²	0.50 ²	0.10 ¹	-	-	-	-
IN 550 XTW	-50 ... 220	0.05	Water	8.0	5.80 ³	5.80 ³	5.80 ³	5.80 ³	5.40 ³	4.00 ³	2.60 ²	1.45 ²	0.55 ²	0.12 ¹	-	-	-	-
IN 750 XT	-45 ... 220	0.05	Air	8.0	7.00 ³	7.00 ³	7.00 ³	7.00 ³	5.40 ³	3.60 ³	2.60 ²	1.60 ²	0.80 ²	-	-	-	-	-
IN 950 XTW	-50 ... 220	0.05	Water	8.0	9.50 ³	9.50 ³	9.50 ³	8.50 ³	6.20 ³	4.30 ³	3.00 ²	1.70 ²	0.90 ²	0.35 ¹	-	-	-	-
IN 1850 XTW	-50 ... 220	0.05	Water	16.0	20.00 ³	20.00 ³	20.00 ³	15.00 ³	11.50 ³	8.50 ³	6.10 ²	3.60 ²	1.90 ²	1.10 ¹	-	-	-	-
IN 2560 XTW	-60 ... 220	0.10	Water	24.0	25.00 ³	25.00 ³	25.00 ³	24.50 ³	22.50 ³	22.00 ³	18.50 ²	12.50 ²	8.70 ²	5.00 ¹	3.00 ²	-	-	-
IN 280 XT	-80 ... 220	0.05	Air	4.0	1.60 ³	1.60 ³	1.60 ³	1.55 ³	1.50 ³	1.50 ³	1.70 ²	1.70 ²	1.65 ²	1.40 ²	0.85 ²	0.35 ²	0.15 ²	-
IN 280 XTW	-80 ... 220	0.05	Water	4.0	1.70 ³	1.70 ³	1.70 ³	1.65 ³	1.60 ³	1.60 ³	1.80 ²	1.80 ²	1.80 ²	1.50 ²	0.90 ²	0.45 ²	0.18 ²	-
IN 590 XTW	-90 ... 220	0.05	Water	8.0	4.50 ³	4.50 ³	4.50 ³	4.45 ³	4.40 ³	4.40 ³	4.60 ²	4.60 ²	4.50 ²	4.20 ²	2.70 ²	1.40 ²	0.60 ²	0.20 ¹
IN 1590 XTW	-90 ... 220	0.05	Water	12.0	18.50 ³	18.50 ³	18.50 ³	15.00 ³	11.50 ³	8.70 ³	8.50 ²	8.50 ²	7.50 ²	6.00 ²	4.00 ²	2.20 ²	0.90 ²	0.35 ¹
IN 4 XTW*	25 ... 320	0.10	Water	3.5	17.00 ³	10.00 ²	-	-	-	-	-	-	-	-	-	-	-	-
IN 8 XTW*	25 ... 320	0.10	Water	8.0	17.00 ³	10.00 ²	-	-	-	-	-	-	-	-	-	-	-	-

LAUDA Integral P / Page 92

IN 2050 PW	-40 ... 140	0.05	Water	16.0	-	20.00 ³	20.00 ³	15.00 ³	10.80 ³	7.80 ³	4.80 ²	3.00 ²	1.60 ²	-	-	-	-	-
IN 2560 PW	-40 ... 140	0.10	Water	24.0	-	25.00 ³	25.00 ³	25.00 ³	24.50 ³	24.00 ³	17.70 ³	11.00 ³	7.50 ³	-	-	-	-	-

*Cooling water supply must be provided for operation

¹Pump output step 2 ²Pump output step 4 ³Pump output step 8

Pump pressure max. bar	Pump flow max. pressure L/min	Pump connection thread mm	Bath volume min. L	Bath volume max. L	Dimensions (W x D x H) mm	Protection Rating	Noise level dB (A)	Weight kg	Loading max. kW	Power supply V; Hz	Part Number	Device type
3.1	65	M30×1.5	2.5	8.7	430×550×760	IP 21	60	103	3.7	230 V; 50 Hz	L002673	IN 150 XT
3.1	65	M30×1.5	2.5	8.7	430×550×760	IP 21	57	106	3.7	230 V; 50 Hz	L002674	IN 250 XTW
3.1	65	M30×1.5	4.8	17.2	560×550×1325	IP 21	65	177	10.5	400 V; 3/PE; 50 Hz & 460 V; 3/PE; 60 Hz	L002675	IN 550 XT
3.1	65	M30×1.5	4.8	17.2	560×550×1325	IP 21	64	177	10.5	400 V; 3/PE; 50 Hz & 460 V; 3/PE; 60 Hz	L002676	IN 550 XTW
3.1	65	M30×1.5	4.8	17.2	560×550×1325	IP 21	68	176	11.0	400 V; 3/PE; 50 Hz & 460 V; 3/PE; 60 Hz	L002677	IN 750 XT
3.1	65	M30×1.5	4.8	17.2	560×550×1325	IP 21	69	176	11.0	400 V; 3/PE; 50 Hz & 460 V; 3/PE; 60 Hz	L002678	IN 950 XTW
6.0	120	M38×1.5	8.0	28.6	760×650×1605	IP 21	62	288	18.0	400 V; 3/PE; 50 Hz & 460 V; 3/PE; 60 Hz	L002680	IN 1850 XTW
6.0	100	M38×1.5	12.6	34.4	1100×895×1865	IP 21	74	613	37.0	400 V; 3/PE; 50 Hz & 460 V; 3/PE; 60 Hz	L002681	IN 2560 XTW
3.1	65	M30×1.5	4.8	17.2	560×550×1325	IP 21	63	198	9.0	400 V; 3/PE; 50 Hz & 460 V; 3/PE; 60 Hz	L002684	IN 280 XT
3.1	65	M30×1.5	4.8	17.2	560×550×1325	IP 21	62	195	9.0	400 V; 3/PE; 50 Hz & 460 V; 3/PE; 60 Hz	L002685	IN 280 XTW
3.1	65	M30×1.5	8.0	28.6	760×650×1605	IP 21	64	279	11.0	400 V; 3/PE; 50 Hz & 460 V; 3/PE; 60 Hz	L002687	IN 590 XTW
3.1	65	M38×1.5	10.0	30.6	760×650×1605	IP 21	65	356	19.0	400 V; 3/PE; 50 Hz & 460 V; 3/PE; 60 Hz	L002689	IN 1590 XTW
3.1	60	M30×1.5	3.3	9.5	430×550×760	IP 21	52	52	3.7	230 V; 50 Hz	L002682	IN 4 XTW
3.1	60	M30×1.5	3.6	9.8	430×550×760	IP 21	52	86	9.0	400 V; 3/PE; 50 Hz & 460 V; 3/PE; 60 Hz	L002683	IN 8 XTW
6.0	120	M38×1.5	11.1	36.3	1100×895×1865	IP 21	58	382	18.0	400 V; 3/PE; 50 Hz & 460 V; 3/PE; 60 Hz	L003214	IN 2050 PW
6.0	100	M38×1.5	12.1	48.1	1100×895×1865	IP 21	74	647	37.0	400 V; 3/PE; 50 Hz & 460 V; 3/PE; 60 Hz	L003308	IN 2560 PW

LAUDA Circulation and process thermostats

Technical data according to DIN 12876 standard

Device type	Working temperature range °C	Temperature stability ±K	Cooling of the refrigerating machine	Heater power max. kW	Cooling output kW													
					200 °C	100 °C	20 °C	10 °C	0 °C	-10 °C	-20 °C	-30 °C	-40 °C	-50 °C	-60 °C	-70 °C	-80 °C	-90 °C

LAUDA Variocool / Page 94

VC 1200	-20 ... 80	0.05	Air	2.3	-	-	1.20	1.00	0.70	0.40	0.14	-	-	-	-	-	-	-
VC 1200	-20 ... 80	0.05	Air	2.3	-	-	1.12	0.92	0.62	0.32	0.06	-	-	-	-	-	-	-
VC 1200 W	-20 ... 80	0.05	Water	2.3	-	-	1.20	1.00	0.70	0.40	0.14	-	-	-	-	-	-	-
VC 1200 W	-20 ... 80	0.05	Water	2.3	-	-	1.12	0.92	0.62	0.32	0.06	-	-	-	-	-	-	-
VC 2000	-20 ... 80	0.05	Air	2.2	-	-	2.00	1.50	1.06	0.68	0.38	-	-	-	-	-	-	-
VC 2000	-20 ... 80	0.05	Air	2.2	-	-	1.92	1.42	0.98	0.60	0.30	-	-	-	-	-	-	-
VC 2000 W	-20 ... 80	0.05	Water	2.2	-	-	2.00	1.50	1.06	0.68	0.38	-	-	-	-	-	-	-
VC 2000 W	-20 ... 80	0.05	Water	2.2	-	-	1.92	1.42	0.98	0.60	0.30	-	-	-	-	-	-	-
VC 3000	-20 ... 80	0.05	Air	1.5	-	-	3.00	2.40	1.68	0.95	0.45	-	-	-	-	-	-	-
VC 3000	-20 ... 80	0.05	Air	1.5	-	-	2.80	2.20	1.48	0.75	0.25	-	-	-	-	-	-	-
VC 3000 W	-20 ... 80	0.05	Water	1.5	-	-	3.00	2.40	1.68	0.95	0.45	-	-	-	-	-	-	-
VC 3000 W	-20 ... 80	0.05	Water	1.5	-	-	2.80	2.20	1.48	0.75	0.25	-	-	-	-	-	-	-
VC 5000	-20 ... 80	0.05	Air	4.5	-	-	5.00	3.90	2.75	1.70	0.90	-	-	-	-	-	-	-
VC 5000	-20 ... 80	0.05	Air	4.5	-	-	4.65	3.55	2.40	1.35	0.55	-	-	-	-	-	-	-
VC 5000 W	-20 ... 80	0.05	Water	4.5	-	-	5.00	3.90	2.75	1.70	0.90	-	-	-	-	-	-	-
VC 5000 W	-20 ... 80	0.05	Water	4.5	-	-	4.65	3.55	2.40	1.35	0.55	-	-	-	-	-	-	-
VC 7000	-20 ... 80	0.10	Air	4.5	-	-	7.00	5.30	3.70	2.40	1.30	-	-	-	-	-	-	-
VC 7000	-20 ... 80	0.10	Air	4.5	-	-	6.65	4.95	3.35	2.05	0.95	-	-	-	-	-	-	-
VC 7000 W	-20 ... 80	0.10	Water	4.5	-	-	7.00	5.30	3.70	2.40	1.30	-	-	-	-	-	-	-
VC 7000 W	-20 ... 80	0.10	Water	4.5	-	-	6.65	4.95	3.35	2.05	0.95	-	-	-	-	-	-	-
VC 10000	-20 ... 80	0.10	Air	7.5	-	-	10.00	7.60	5.30	3.50	2.00	-	-	-	-	-	-	-
VC 10000	-20 ... 80	0.10	Air	7.5	-	-	9.65	7.25	4.95	3.15	1.65	-	-	-	-	-	-	-
VC 10000 W	-20 ... 80	0.10	Water	7.5	-	-	10.00	7.60	5.30	3.50	2.00	-	-	-	-	-	-	-
VC 10000 W	-20 ... 80	0.10	Water	7.5	-	-	9.65	7.25	4.95	3.15	1.65	-	-	-	-	-	-	-

LAUDA Semistat / Page 96

S 1200	-20 ... 90	0.10	Water	3.0	-	-	1.20	0.90	0.60	0.35	0.08	-	-	-	-	-	-	-
S 2400	-20 ... 90	0.10	Water	6.0	-	-	2.45	1.93	1.40	0.88	0.20	-	-	-	-	-	-	-
S 4400	-20 ... 90	0.10	Water	12.0	-	-	4.40	3.50	2.60	1.65	0.70	-	-	-	-	-	-	-

Pump pressure max. bar	Pump flow max. pressure L/min	Pump connection thread mm	Bath volume min. L	Bath volume max. L	Dimensions (W x D x H) mm	Protection Rating	Noise level dB (A)	Weight kg	Loading max. kW	Power supply V; Hz	Part Number	Device type
0.9	28	G 3/4	8	15	450×550×650	IP 32	51	51	3.3	230 V; 50 Hz	L000712	VC 1200
3.2	37	G 3/4	8	15	450×550×790	IP 32	53	51	3.3	230 V; 50 Hz	L000923	VC 1200
0.9	28	G 3/4	8	15	450×550×650	IP 32	50	50	3.3	230 V; 50 Hz	L000732	VC 1200 W
3.2	37	G 3/4	8	15	450×550×790	IP 32	52	50	3.3	230 V; 50 Hz	L000956	VC 1200 W
0.9	28	G 3/4	8	15	450×550×650	IP 32	52	63	3.3	230 V; 50 Hz	L000714	VC 2000
3.2	37	G 3/4	8	15	450×550×790	IP 32	56	63	3.3	230 V; 50 Hz	L000927	VC 2000
0.9	28	G 3/4	8	15	450×550×650	IP 32	50	58	3.3	230 V; 50 Hz	L000734	VC 2000 W
3.2	37	G 3/4	8	15	450×550×790	IP 32	53	64	3.3	230 V; 50 Hz	L000960	VC 2000 W
3.2	37	G 3/4	20	33	550×650×970	IP 32	57	89	2.6	230 V; 50 Hz	L000715	VC 3000
4.8	37	G 3/4	20	33	550×650×970	IP 32	61	89	2.6	230 V; 50 Hz	L000929	VC 3000
3.2	37	G 3/4	20	33	550×650×970	IP 32	55	88	2.6	230 V; 50 Hz	L000735	VC 3000 W
4.8	37	G 3/4	20	33	550×650×970	IP 32	59	88	2.6	230 V; 50 Hz	L000962	VC 3000 W
3.2	37	G 3/4	20	33	550×650×970	IP 32	65	97	7.8	400 V; 3/N/PE; 50 Hz	L000728	VC 5000
5.0	60	G 3/4	20	33	550×650×970	IP 32	69	97	7.8	400 V; 3/N/PE; 50 Hz	L000949	VC 5000
3.2	37	G 3/4	20	33	550×650×970	IP 32	64	97	7.8	400 V; 3/N/PE; 50 Hz	L000746	VC 5000 W
5.0	60	G 3/4	20	33	550×650×970	IP 32	68	97	7.8	400 V; 3/N/PE; 50 Hz	L001995	VC 5000 W
3.2	37	G 1 1/4	48	64	650×670×1250	IP 32	66	124	8.8	400 V; 3/N/PE; 50 Hz	L000729	VC 7000
5.0	60	G 1 1/4	48	64	650×670×1250	IP 32	69	124	8.8	400 V; 3/N/PE; 50 Hz	L000951	VC 7000
3.2	37	G 1 1/4	48	64	650×670×1250	IP 32	60	122	8.8	400 V; 3/N/PE; 50 Hz	L000747	VC 7000 W
5.0	60	G 1 1/4	48	64	650×670×1250	IP 32	64	133	8.8	400 V; 3/N/PE; 50 Hz	L000983	VC 7000 W
3.2	37	G 1 1/4	48	64	650×670×1250	IP 32	67	137	11.1	400 V; 3/N/PE; 50 Hz	L000730	VC 10000
5.0	60	G 1 1/4	48	64	650×670×1250	IP 32	70	137	11.1	400 V; 3/N/PE; 50 Hz	L000953	VC 10000
3.2	37	G 1 1/4	48	64	650×670×1250	IP 32	61	131	11.1	400 V; 3/N/PE; 50 Hz	L000748	VC 10000 W
5.0	60	G 1 1/4	48	64	650×670×1250	IP 32	65	131	11.1	400 V; 3/N/PE; 50 Hz	L000985	VC 10000 W
2.8	22	1/2"	1.00	1.30	116×232×470	-	-	15	-	-	L003276	S 1200
2.8	22	1/2"	1.25	1.60	116×300×560	-	-	25	-	-	L003277	S 2400
2.8	27	1/2"	2.50	2.80	194×300×560	-	-	38	-	-	L003278	S 4400

LAUDA Circulation and process thermostats

Power supply variants

Device type	Power supply V; Hz	Heater power max. kW	Pump pressure max. 60 Hz bar	Pump flow max. pressure 60 Hz L/min	Loading max. kW	Plug code*	Part Number	Device type	Power supply V; Hz	Heater power max. kW	Pump pressure max. 60 Hz bar	Pump flow max. pressure 60 Hz L/min	Loading max. kW	Plug code*	Part Number
P 2 E	100-120 V; 50/60 Hz	1.8	0.7	22.0	1.9	32	L000557	RP 245 E	120 V; 60 Hz	1.8	0.7	22.0	1.9	32	L000461
P 2 E	100-120 V; 50/60 Hz	1.8	0.7	22.0	1.9	4	L000549	RP 245 E	120 V; 60 Hz	1.8	0.7	22.0	1.9	4	L000453
P 2 EC	100-120 V; 50/60 Hz	1.8	0.7	22.0	1.9	32	L000561	RP 245 E	200 V; 50/60 Hz	1.9	0.7	22.0	3.2	32	L000521
P 2 EC	100-120 V; 50/60 Hz	1.8	0.7	22.0	1.9	4	L000553	RP 245 E	200 V; 50/60 Hz	1.9	0.7	22.0	3.2	31	L000505
RP 240 E	100 V; 50/60 Hz	1.3	0.7	22.0	1.6	32	L000540	RP 245 E	200 V; 50/60 Hz	1.9	0.7	22.0	3.2	3	L000489
RP 240 E	100 V; 50/60 Hz	1.3	0.7	22.0	1.5	14	L000532	RP 245 E	208-220 V; 60 Hz	2.3	0.7	22.0	3.5	31	L000425
RP 240 E	120 V; 60 Hz	1.8	0.7	22.0	1.9	32	L000460	RP 245 E	208-220 V; 60 Hz	2.3	0.7	22.0	3.5	3	L000313
RP 240 E	120 V; 60 Hz	1.8	0.7	22.0	1.9	4	L000452	RP 245 E	208-220 V; 60 Hz	2.3	0.7	22.0	3.5	32	L000441
RP 240 E	200 V; 50/60 Hz	1.9	0.7	22.0	3.2	3	L000488	RP 245 EC	100 V; 50/60 Hz	1.3	0.7	22.0	1.6	32	L000545
RP 240 E	200 V; 50/60 Hz	1.9	0.7	22.0	3.2	32	L000520	RP 245 EC	100 V; 50/60 Hz	1.3	0.7	22.0	1.5	14	L000537
RP 240 E	200 V; 50/60 Hz	1.9	0.7	22.0	3.2	31	L000504	RP 245 EC	120 V; 60 Hz	1.8	0.7	22.0	1.9	4	L000457
RP 240 E	208-220 V; 60 Hz	2.3	0.7	22.0	3.5	32	L000440	RP 245 EC	120 V; 60 Hz	1.8	0.7	22.0	1.9	32	L000465
RP 240 E	208-220 V; 60 Hz	2.3	0.7	22.0	3.5	3	L000312	RP 245 EC	200 V; 50/60 Hz	1.9	0.7	22.0	3.2	32	L000529
RP 240 E	208-220 V; 60 Hz	2.3	0.7	22.0	3.5	31	L000424	RP 245 EC	200 V; 50/60 Hz	1.9	0.7	22.0	3.2	31	L000513
RP 240 EC	100 V; 50/60 Hz	1.3	0.7	22.0	1.6	32	L000544	RP 245 EC	200 V; 50/60 Hz	1.9	0.7	22.0	3.2	3	L000497
RP 240 EC	100 V; 50/60 Hz	1.3	0.7	22.0	1.5	14	L000536	RP 245 EC	208-220 V; 60 Hz	2.3	0.7	22.0	3.5	3	L000321
RP 240 EC	120 V; 60 Hz	1.8	0.7	22.0	1.9	32	L000464	RP 245 EC	208-220 V; 60 Hz	2.3	0.7	22.0	3.5	32	L000449
RP 240 EC	120 V; 60 Hz	1.8	0.7	22.0	1.9	4	L000456	RP 245 EC	208-220 V; 60 Hz	2.3	0.7	22.0	3.5	31	L000433
RP 240 EC	200 V; 50/60 Hz	1.9	0.7	22.0	3.2	31	L000512	RP 250 E	200 V; 50/60 Hz	1.9	0.7	22.0	3.2	3	L002498
RP 240 EC	200 V; 50/60 Hz	1.9	0.7	22.0	3.2	3	L000496	RP 250 EC	200 V; 50/60 Hz	1.9	0.7	22.0	3.2	3	L002499
RP 240 EC	200 V; 50/60 Hz	1.9	0.7	22.0	3.2	32	L000528	RP 250 E	208-220 V; 60 Hz	2.3	0.7	22.0	3.5	3	L002657
RP 240 EC	208-220 V; 60 Hz	2.3	0.7	22.0	3.5	32	L000448	RP 250 EC	208-220 V; 60 Hz	2.3	0.7	22.0	3.5	3	L002658
RP 240 EC	208-220 V; 60 Hz	2.3	0.7	22.0	3.5	3	L000320	RP 290 E	200 V; 50/60 Hz	1.9	0.7	22.0	3.2	3	L002506
RP 240 EC	208-220 V; 60 Hz	2.3	0.7	22.0	3.5	31	L000432	RP 290 EC	200 V; 50/60 Hz	1.9	0.7	22.0	3.2	3	L002507
RP 245 E	100 V; 50/60 Hz	1.3	0.7	22.0	1.6	32	L000541	RP 290 E	208-220 V; 60 Hz	2.3	0.7	22.0	3.5	3	L002659
RP 245 E	100 V; 50/60 Hz	1.3	0.7	22.0	1.5	14	L000533	RP 290 EC	208-220 V; 60 Hz	2.3	0.7	22.0	3.5	3	L002660

*All data for the plug codes can be found on page 162

Device type	Power supply V; Hz	Heater power max. kW	Pump pressure max. 60 Hz bar	Pump flow max. pressure 60 Hz L/min	Loading max. kW	Plug code*	Part Number	Device type	Power supply V; Hz	Heater power max. kW	Pump pressure max. 60 Hz bar	Pump flow max. pressure 60 Hz L/min	Loading max. kW	Plug code*	Part Number
-------------	--------------------	----------------------	------------------------------	-------------------------------------	-----------------	------------	-------------	-------------	--------------------	----------------------	------------------------------	-------------------------------------	-----------------	------------	-------------

LAUDA Integral T / Page 88

IN 130 T	200 V; 50/60 Hz	2.2	4.5	45	3.2	3	L002787	IN 230 TW	200 V; 50/60 Hz	2.2	4.5	45	3.2	3	L002790
IN 130 T	208-220 V; 60 Hz	2.7	4.5	45	3.5	3	L002788	IN 530 T	400 V; 3/PE; 50 Hz & 460 V; 3/PE; 60 Hz	8.0	4.6	65	11.0	34	L002883
IN 230 T	208-220 V; 60 Hz	2.7	4.5	45	3.5	2	L003302	IN 530 TW	400 V; 3/PE; 50 Hz & 460 V; 3/PE; 60 Hz	8.0	4.6	65	11.0	34	L002884
IN 230 T	208-220 V; 60 Hz	2.7	4.5	45	3.5	3	L002791	IN 1030 T	400 V; 3/PE; 50 Hz & 460 V; 3/PE; 60 Hz	8.0	7.0	70	11.0	34	L002885
IN 230 T	200 V; 50/60 Hz	2.2	4.5	45	3.2	3	L002789	IN 1330 TW	400 V; 3/PE; 50 Hz & 460 V; 3/PE; 60 Hz	16.0	7.0	70	18.0	33	L002886
IN 230 TW	208-220 V; 60 Hz	2.7	4.5	45	3.5	2	L003303	IN 1830 TW	400 V; 3/PE; 50 Hz & 460 V; 3/PE; 60 Hz	16.0	7.0	70	18.0	33	L003274
IN 230 TW	208-220 V; 60 Hz	2.7	4.5	45	3.5	3	L002792								

LAUDA Integral XT / Page 90

IN 150 XT	208-220 V; 60 Hz	3.3	3.1	65	3.5	3	L002794	IN 950 XTW	400 V; 3/PE; 50 Hz & 460 V; 3/PE; 60 Hz	8.0	3.1	65	11.0	34	L002890
IN 150 XT	200 V; 50/60 Hz	3.0	3.1	65	3.2	3	L002793	IN 1850 XTW	400 V; 3/PE; 50 Hz & 460 V; 3/PE; 60 Hz	16.0	6.0	120	18.0	33	L002895
IN 150 XT	208-220 V; 60 Hz	3.3	3.1	65	3.5	2	L003304	IN 280 XT	400 V; 3/PE; 50 Hz & 460 V; 3/PE; 60 Hz	4.0	3.1	65	9.0	34	L002892
IN 250 XTW	208-220 V; 60 Hz	3.4	3.1	65	3.5	2	L003305	IN 280 XTW	400 V; 3/PE; 50 Hz & 460 V; 3/PE; 60 Hz	4.0	3.1	65	9.0	34	L002893
IN 250 XTW	208-220 V; 60 Hz	3.4	3.1	65	3.5	3	L002796	IN 590 XTW	400 V; 3/PE; 50 Hz & 460 V; 3/PE; 60 Hz	8.0	3.1	65	11.0	34	L002897
IN 250 XTW	200 V; 50/60 Hz	3.1	3.1	65	3.2	3	L002795	IN 1590 XTW	400 V; 3/PE; 50 Hz & 460 V; 3/PE; 60 Hz	12.0	3.1	65	19.0	33	L002898
IN 550 XT	400 V; 3/PE; 50 Hz & 460 V; 3/PE; 60 Hz	8.0	3.1	65	10.5	34	L002887	IN 4 XTW	200 V; 50/60 Hz	2.9	3.1	60	3.2	3	L002799
IN 550 XTW	400 V; 3/PE; 50 Hz & 460 V; 3/PE; 60 Hz	8.0	3.1	65	10.5	34	L002888	IN 4 XTW	208-220 V; 60 Hz	3.3	3.1	60	3.5	3	L002800
IN 750 XT	400 V; 3/PE; 50 Hz & 460 V; 3/PE; 60 Hz	8.0	3.1	65	11.0	34	L002889	IN 8 XTW	400 V; 3/PE; 50 Hz & 460 V; 3/PE; 60 Hz	8.0	3.1	60	9.0	34	L002891

LAUDA Integral P / Page 92

IN 2050 PW	400 V; 3/PE; 50 Hz & 460 V; 3/PE; 60 Hz	16.0	6.0	120	18.0	33	L003319								
------------	---	------	-----	-----	------	----	---------	--	--	--	--	--	--	--	--

LAUDA Circulation and process thermostats

Power supply variants

Device type	Power supply V; Hz	Heater power max. kW	Pump pressure max. 60 Hz ^{bar}	Pump flow max. pressure 60 Hz L /min	Loading max. kW	Plug code*	Part Number	Device type	Power supply V; Hz	Heater power max. kW	Pump pressure max. 60 Hz ^{bar}	Pump flow max. pressure 60 Hz L /min	Loading max. kW	Plug code*	Part Number
LAUDA Variocool / Page 94															
VC 1200	200 V; 50/60 Hz	1.7	0.9	28	2.9	3	L000769	VC 5000 W	200 V; 3/PE; 50/60 Hz	3.4	3.2	37	4.3	34	L000781
VC 1200	200 V; 50/60 Hz	1.1	0.9	28	2.3	3	L000768	VC 5000 W	200 V; 3/PE; 50/60 Hz	3.4	4.3	60	4.3	34	L001041
VC 1200	208-220 V; 60 Hz	2.1	0.9	28	3.1	3	L000752	VC 5000 W	208-220 V; 3/PE; 60 Hz	4.1	3.2	37	4.5	34	L000764
VC 1200 W	200 V; 50/60 Hz	1.7	0.9	28	2.9	3	L000777	VC 5000 W	208-220 V; 3/PE; 60 Hz	4.1	5.0	60	4.5	34	L001011
VC 1200 W	208-220 V; 60 Hz	2.1	0.9	28	3.1	3	L000760	VC 7000	200 V; 3/PE; 50/60 Hz	3.4	3.2	37	5.4	33	L000774
VC 2000	200 V; 50/60 Hz	1.7	0.9	28	2.9	3	L000771	VC 7000	200 V; 3/PE; 50/60 Hz	3.4	4.3	60	5.4	33	L001028
VC 2000	208-220 V; 60 Hz	2.1	0.9	28	3.2	3	L000754	VC 7000	208-220 V; 3/PE; 60 Hz	4.1	3.2	37	5.7	33	L000757
VC 2000 W	200 V; 50/60 Hz	1.7	0.9	28	2.9	3	L000779	VC 7000	208-220 V; 3/PE; 60 Hz	4.1	5.0	60	5.7	33	L000998
VC 2000 W	208-220 V; 60 Hz	2.1	0.9	28	3.2	3	L000762	VC 7000 W	200 V; 3/PE; 50/60 Hz	3.4	3.2	37	5.4	33	L000782
VC 3000	200 V; 50/60 Hz	1.0	3.2	37	2.6	3	L000772	VC 7000 W	200 V; 3/PE; 50/60 Hz	3.4	4.3	60	5.4	33	L001043
VC 3000	200 V; 50/60 Hz	1.1	4.8	37	2.6	3	L001024	VC 7000 W	208-220 V; 3/PE; 60 Hz	4.1	3.2	37	5.7	33	L000765
VC 3000	208-220 V; 60 Hz	1.3	3.2	37	2.8	3	L000755	VC 7000 W	208-220 V; 3/PE; 60 Hz	4.1	5.0	60	5.7	33	L001013
VC 3000	208-220 V; 60 Hz	1.3	4.8	37	2.8	3	L000994	VC 10000	200 V; 3/PE; 50/60 Hz	5.7	3.2	37	7.6	33	L000775
VC 3000 W	200 V; 50/60 Hz	1.0	3.2	37	2.6	3	L000780	VC 10000	200 V; 3/PE; 50/60 Hz	5.7	4.3	60	7.6	33	L001030
VC 3000 W	200 V; 50/60 Hz	1.1	4.8	37	2.6	3	L001039	VC 10000	208-220 V; 3/PE; 60 Hz	6.9	3.2	37	7.7	33	L000758
VC 3000 W	208-220 V; 60 Hz	1.3	3.2	37	2.8	3	L000763	VC 10000	208-220 V; 3/PE; 60 Hz	6.9	5.0	60	7.7	33	L001000
VC 3000 W	208-220 V; 60 Hz	1.3	4.8	37	2.8	3	L001009	VC 10000 W	200 V; 3/PE; 50/60 Hz	5.7	3.2	37	7.6	33	L000783
VC 5000	200 V; 3/PE; 50/60 Hz	3.4	3.2	37	4.3	34	L000773	VC 10000 W	200 V; 3/PE; 50/60 Hz	5.7	4.3	60	7.6	33	L001045
VC 5000	200 V; 3/PE; 50/60 Hz	3.4	4.3	60	4.3	34	L001026	VC 10000 W	208-220 V; 3/PE; 60 Hz	6.9	3.2	37	7.7	33	L000766
VC 5000	208-220 V; 3/PE; 60 Hz	4.1	3.2	37	4.5	34	L000756	VC 10000 W	208-220 V; 3/PE; 60 Hz	6.9	5.0	60	7.7	33	L001015
VC 5000	208-220 V; 3/PE; 60 Hz	4.1	5.0	60	4.5	34	L000996								

*All data for the plug codes can be found on page 162

LAUDA Circulation and process thermostats

More characteristics

LAUDA Integral IN 150 XT, 250 XTW, 280 XT, 280 XTW, 590 XT, 590 XTW, 550 XT, 550 XTW, 750 XT, 950 XTW, 1350 XTW, 1590 XTW / Page 90

LAUDA Integral IN 4 XTW, IN 8 XTW / Page 90

PUMP CHARACTERISTICS Liquid: Water

Pressure [bar]

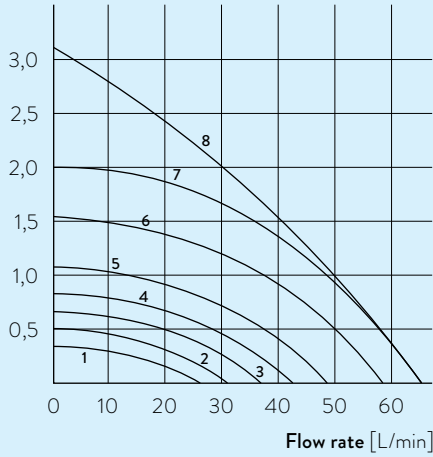

- 1 Stage 1
- 2 Stage 2
- 3 Stage 3
- 4 Stage 4
- 5 Stage 5
- 6 Stage 6
- 7 Stage 7
- 8 Stage 8

PUMP CHARACTERISTICS Liquid: Water

Pressure [bar]

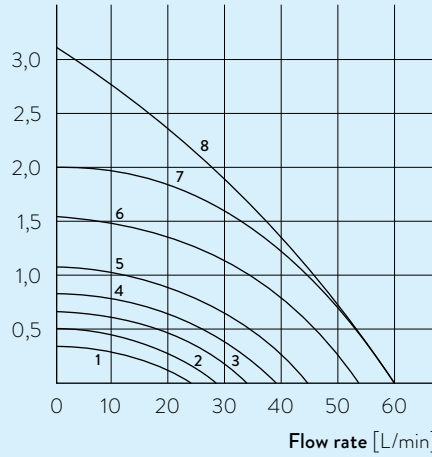

- 1 Stage 1
- 2 Stage 2
- 3 Stage 3
- 4 Stage 4
- 5 Stage 5
- 6 Stage 6
- 7 Stage 7
- 8 Stage 8

LAUDA Integral IN 1850 XTW, IN 2050 PW / Page 90, 92

LAUDA Integral IN 2560 XTW / PW / Page 90, 92

PUMP CHARACTERISTICS Liquid: Water

Pressure [bar]

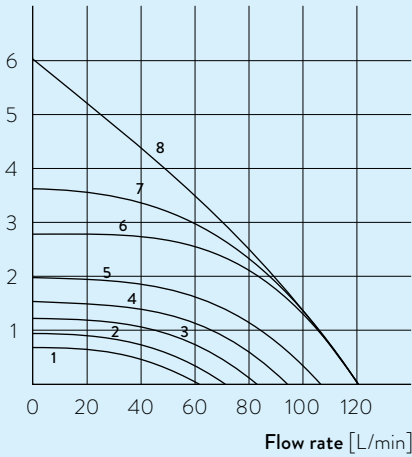

- 1 Stage 1
- 2 Stage 2
- 3 Stage 3
- 4 Stage 4
- 5 Stage 5
- 6 Stage 6
- 7 Stage 7
- 8 Stage 8

PUMP CHARACTERISTICS Liquid: Water

Pressure [bar]

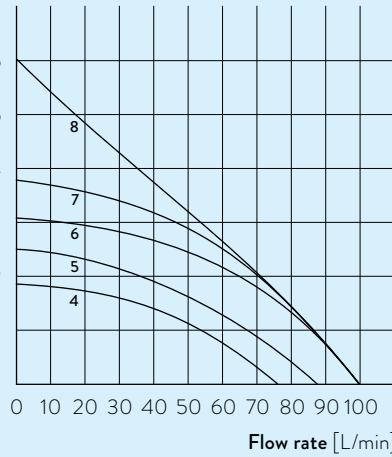

- 4 Stage 4
- 5 Stage 5
- 6 Stage 6
- 7 Stage 7
- 8 Stage 8

LAUDA Integral IN 130 T, IN 230 T, IN 230 TW, IN 530 T, IN 530 TW / Page 88

LAUDA Integral IN 1030 T, IN 1330 TW, IN 1830 TW / Page 88

PUMP CHARACTERISTICS Liquid: Water

Pressure [bar]

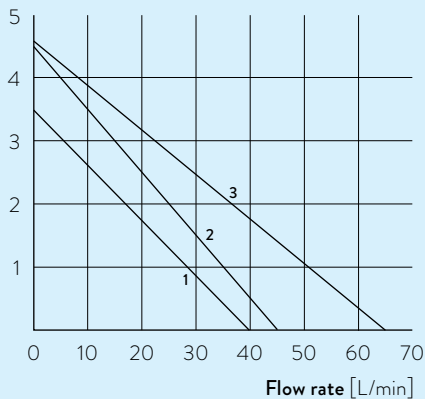

- 1 50 Hz
- 2 60 Hz
(IN 130 T,
IN 230 T,
IN 230 TW)
- 3 60 Hz
(IN 530 T,
IN 530 TW)

PUMP CHARACTERISTICS Liquid: Water

Pressure [bar]

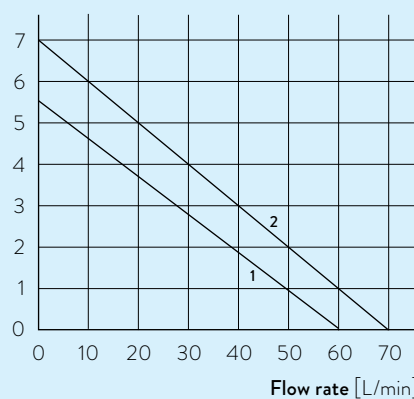

- 1 50 Hz
- 2 60 Hz

PUMP CHARACTERISTIC Water

Pressure bar

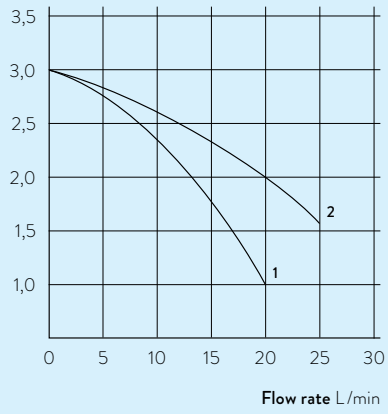

2 S 4400
1 S 1200, S 2400

LAUDA CIRCULATION CHILLERS

Specific application examples

- Rotary evaporators
- Distillation systems
- Spectrometers
- Supply of cooling traps
- Digital printing
- Laser cutting
- Laser sorting
- Point welding
- Injection molding
- Tunnel drilling machines
- Centralized cooling water supply



LAUDA Microcool

Circulation chillers for reliable continuous operation in laboratory and research applications from -10 to 40°C

-10°C  40°C

Compact circulation chillers with outstanding price-performance ratio

The LAUDA Microcool line of user-friendly circulation chillers consists of four compact models with large LED display and membrane keypad, offering cooling capacities of 0.25 to 1.2 kW. The highlight of these devices is the premium quality centrifugal pump with magnetic coupling – unique to this price category: Magnetic coupling of pump and electric motor prevents any kind of seal issue from arising on the pump shaft, eliminating the chance for any fluid to leak.



Illuminated viewing glass enables quick identification of the fill level



Standard-issue RS 232 interface and alarm contact

PUMP CHARACTERISTICS Water

Pressure bar

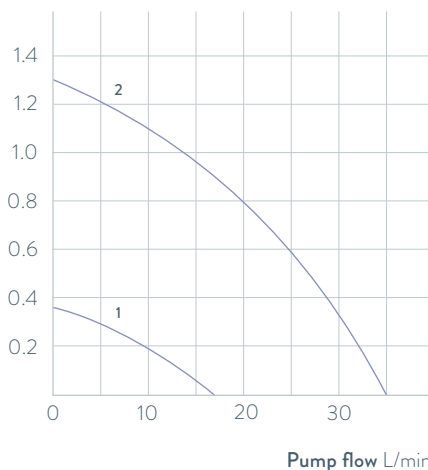

1 MC 250
MC 350
2 MC 600
MC 1200

Important functions

- Auto-start timer and auto shutdown function
- Filling opening at the top, drain connection at the rear
- Cooling capacity adapted via solenoid valve control, including automatic compressor control

Included accessories

Nipples, screw caps

Further accessories

Tubing

All technical data and power supply variants can be found in the ›Technical data‹ section.

More at www.lauda.de/1764



LAUDA Microcool

The compact circulation chillers MC 250 and MC 350 fit effortlessly on a lab bench. Somewhat larger models are also available having 600 and 1200 watts of cooling capacity and which can be positioned on the floor under a lab bench to save space.



LAUDA Ultracool

Energy-efficient process circulation chillers from -10 to 35°C



LAUDA Ultracool circulation chillers with an energy saving of up to 50 percent

Developed with a focus on energy efficiency, the new LAUDA Ultracool circulation chillers make a pivotal contribution to reducing your operating costs. Depending on the operating conditions, the new devices make it possible to reduce energy costs by up to 50 percent, with payback times of less than one year. The innovative operating concept enables the LAUDA Ultracool circulation chillers to be conveniently monitored and controlled from a distance – via a connected remote control or the integrated web server on a PC or laptop or connected to the LAUDA.LIVE Cloud via a 4G wireless gateway. This allows comfortable operation via PC or laptop.



Suitable for outdoor installation (IP 54)



LAUDA Ultracool UC 2/UC 4 in a compact size

PUMP CHARACTERISTIC Standard pumps (3 bar), 50 Hz

Pressure bar

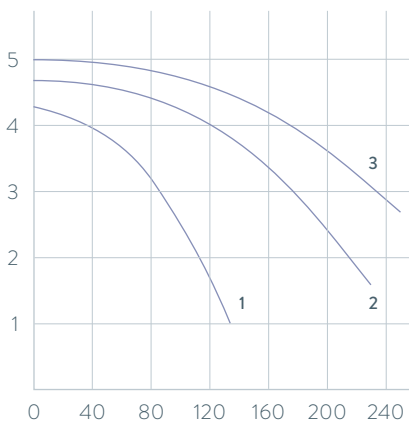

- 3 UC 65
- 2 UC 50
- 1 UC 8, UC 14, UC 24

Important functions

- High energy efficiency results in low operating costs
- Operation via LCD remote control unit or web server
- Increased temperature stability of $\pm 0.5\text{ K}$
- Remote monitoring and maintenance via LAUDA.LIVE

Included accessories

Ethernet interface, remote control unit, stainless steel connections

Further accessories

Hose kits, reverse flow protection, 4G wireless gateway

All technical data and power supply variants can be found in the »Technical data« section.

More at www.lauda.de/de/1778

NEW

LAUDA.LIVE
ready



LAUDA Ultracool

The energy-efficient LAUDA Ultracool circulation chillers comply with the Ecodesign Directive 2009/125/EC. This defines performance requirements with regard to energy efficiency (SEPR indices) that process circulation chillers in this performance class must fulfill. LAUDA Ultracool chillers meet and some even exceed these requirements. Depending on the operating conditions, the new circulation chillers are up to 50 percent more energy-efficient than conventional models.



LAUDA Circulation chillers

Device type overview

LAUDA Microcool / Page 116

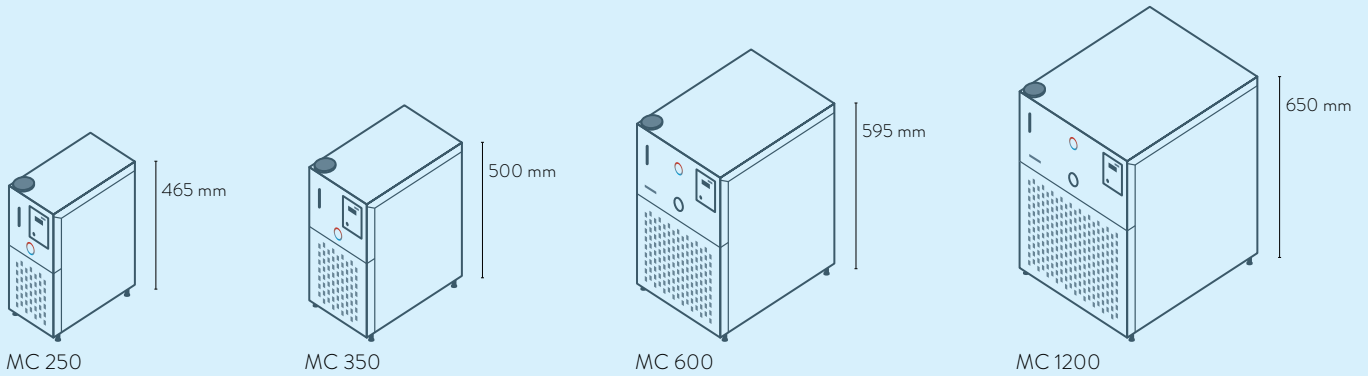

LAUDA Ultracool / Page 118

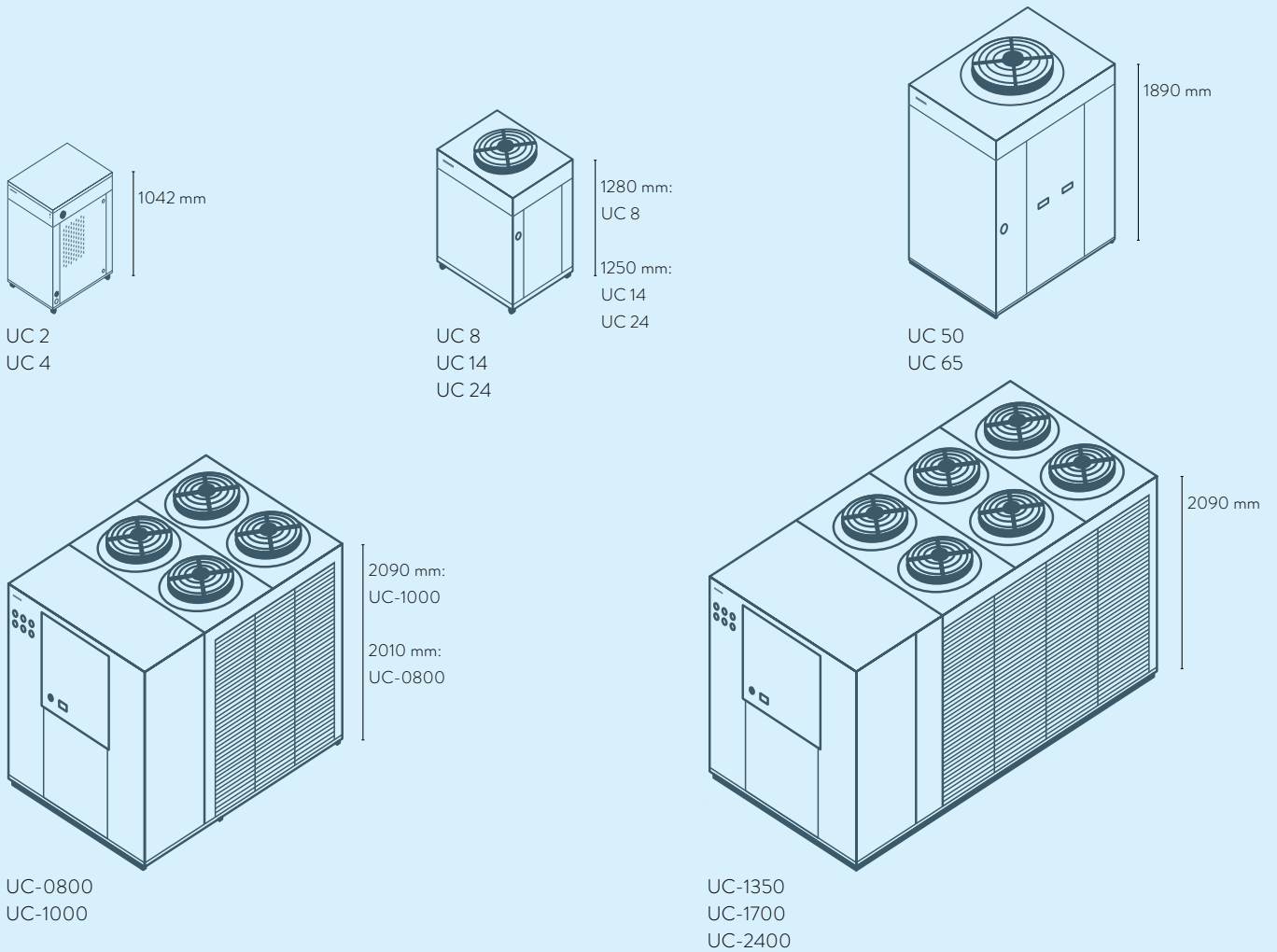

LAUDA Circulation chillers

Interfaces

	Pt 100 (1)	Pt 100 (2)	USB	Ethernet	RS 232 / 485	Analog	Namur contact	D-Sub contact	PROFIBUS	EtherCAT M8	EtherCAT RJ 45	Modbus	Malfunction contact	Number of module slots, large	Number of module slots, small
LAUDA Microcool / Page 116	-	-	-	-	RS 232	-	-	-	-	-	-	-	S	-	-
LAUDA Ultracool / Page 118	-	-	-	S*	-	-	-	-	-	-	-	-	S	-	-

S = Series standard

S* = Ethernet with Modbus TCP/IP protocol

LAUDA Circulation chillers

Function overview

Operating element	Microcool	Ultracool
Display	7-Segment	LCD
Mode of operation	3-button	6-button
1-point calibration	✓	-
Programmer, programs/segments	-	-
Programmer, tolerance range function	-	-
Graphic temperature profile display	-	-
Pump pressure display (analog)	- / ✓	✓
Pump pressure display (digital)	-	✓
Adjustable bypass	-	-
Level indicator (analog)	✓	-
Level indicator (digital)	-	✓
Standby timer	✓	✓
Flow control instrument	-	-
Overflow	✓	-
Low-level alarm	✓	✓
Drain tap	-	✓
Drain screw	✓	-

LAUDA Circulation chillers

Technical data according to DIN 12876 standard

Device type	Working temperature range °C	Temperature stability* ±K	Ambient temperature range °C	Cooling of the refrigerating machine	Heater power max. kW	Cooling output kW					Pump pressure max. bar	Pump flow max. pressure L/min	Pump connection thread mm	Bath volume min. L
						20 °C	10 °C	0 °C	-10 °C	-20 °C				
LAUDA Microcool / Page 116														
MC 250	-10 ... 40	0.50	5 ... 40	Air	-	0.25	0.20	0.15	0.09	-	0.35	16	Ø 10 mm	2.0
MC 350	-10 ... 40	0.50	5 ... 40	Air	-	0.35	0.27	0.20	0.12	-	0.35	16	Ø 10 mm	4.0
MC 600	-10 ... 40	0.50	5 ... 40	Air	-	0.60	0.50	0.36	0.15	-	1.3	35	G 3/4	4.0
MC 1200	-10 ... 40	0.50	5 ... 40	Air	-	1.20	1.05	0.75	0.40	-	1.3	35	G 3/4	7.0

Bath volume max. L	Dimensions (W x D x H) mm	Protection Rating	Noise level dB (A)	Weight kg	Loading max. kW	Power supply V; Hz	Part Number	Device type
4.0	200 x 350 x 465	IP 32	60	25.0	0.2	230 V; 50 Hz & 220 V; 60 Hz	L001046	MC 250
7.0	240 x 400 x 500	IP 32	60	34.0	0.5	230 V; 50 Hz	L001047	MC 350
8.0	350 x 480 x 595	IP 32	57	50.0	0.7	230 V; 50 Hz	L001048	MC 600
14.0	450 x 550 x 650	IP 32	59	63.0	1.2	230 V; 50 Hz	L001049	MC 1200

LAUDA Circulation chillers

Technical data

Device type	Working temperature range °C	Temperature stability ±K	Ambient temperature range °C	Cooling output at water outlet temperature ¹ kW								Number of refrigerant circuits	Motor fan			Max. discharge pressure bar
				35 - 25 °C	20 °C	15 °C	10 °C	5 °C	0 °C	-5 °C	-10 °C		No.	kW	m ³ /h	
LAUDA Ultracool / Page 118																
UC 2	-10...35	0.5	-15...50	3.10	3.10	2.80	2.40	2.00	1.70	1.40	1.20	1	1	0.2	3050	3.4
UC 2	-10...35	0.5	-15...50	3.10	3.10	2.80	2.40	2.00	1.70	1.40	1.20	1	1	0.2	3050	5.5
UC 4	-10...35	0.5	-15...50	6.10	6.10	5.50	4.80	3.90	3.30	2.80	2.40	1	1	0.2	3050	3.4
UC 4	-10...35	0.5	-15...50	6.10	6.10	5.50	4.80	3.90	3.30	2.80	2.40	1	1	0.2	3050	5.5
UC 8	-10...35	0.5	-15...50	13.3	13.3	12.0	10.2	8.5	7.0	5.4	4.4	1	1	0.5	4500	5.6
UC 8	-10...35	0.5	-15...50	13.3	13.3	12.0	10.2	8.5	7.0	5.4	4.4	1	1	0.5	4500	4.2
UC 14	-10...35	0.5	-15...50	22.4	20.3	18.4	15.8	13.4	11.1	9.3	7.6	1	1	1.0	7500	5.6
UC 14	-10...35	0.5	-15...50	22.4	20.3	18.4	15.8	13.4	11.1	9.3	7.6	1	1	1.0	7500	4.2
UC 24	-10...35	0.5	-15...50	34.0	30.9	28.1	24.3	20.8	17.3	14.5	12.0	1	1	1.0	7500	5.8
UC 24	-10...35	0.5	-15...50	34.0	30.9	28.1	24.3	20.8	17.3	14.5	12.0	1	1	1.0	7500	4.2
UC 50	-10...35	0.5	-15...50	67.5	65.6	59.4	51.2	43.7	36.4	30.4	25.2	1	1	2.6	19000	6.5
UC 50	-10...35	0.5	-15...50	67.5	65.6	59.4	51.2	43.7	36.4	30.4	25.2	1	1	2.6	19000	4.6
UC 65	-10...35	0.5	-15...50	87.5	85.2	77.4	66.9	57.3	47.8	40.1	33.3	1	1	2.6	19000	6.9
UC 65	-10...35	0.5	-15...50	87.5	85.2	77.4	66.9	57.3	47.8	40.1	33.3	1	1	2.6	19000	5.0
UC-0800	-5...25	2	-15...45	114.3	114.3	103.0	87.9	72.3	57.8	45.4	-	2	4	2.4	36000	4.6
UC-1000	-5...25	2	-15...45	140.8	140.8	126.1	106.4	85.9	67.0	51.2	-	2	4	2.4	40800	3.7
UC-1350	-5...25	2	-15...45	182.1	182.1	163.7	139.2	113.7	90.0	69.8	-	2	6	3.6	57000	5.5
UC-1700	-5...25	2	-15...45	228.4	228.4	205.9	175.7	144.6	115.6	90.8	-	2	6	3.6	55200	5.2
UC-2400	-5...25	2	-15...45	336.9	336.9	308.8	265.0	223.1	182.8	148.2	-	2	6	7.5	66000	5.2

¹ at 25 °C ambient temperature

² Rp = G = BSP (internal screw thread acc. to British Standard Pipe)

Correction factor ambient temperature; $C_{NOM} = C_{WORK} \times F$

Ambient temperature	25	30	35	40	45
Correction factor F	1	0.9	0.85	0.78	0.66

Note: The values calculated with the correction factors are only approximated values

Pump flow max. L/min	Nominal discharge pressure bar	Pump flow nominal L/min	Pump connection thread ² mm	Volume water tank L	Dimensions (W x D x H) mm	Protection Rating	Noise level ¹ dB (A)	Weight kg	Loading max. kW	Max. fuse A	Power supply V; Hz	SEPR	Part Number	Device type
42	3.3	5.6	Rp 1/2	12	510×680×1042	IP 32	53.5	115	1.0	16	230 V; 50 Hz	6.24	L003509	UC 2
68	5.3	5.6	Rp 1/2	12	510×680×1042	IP 32	53.5	115	1.2	16	230 V; 50 Hz	6.24	L003510	UC 2
42	2.8	13.8	Rp 1/2	12	510×680×1042	IP 32	57.9	115	1.8	16	230 V; 50 Hz	5.23	L003511	UC 4
68	5.0	13.8	Rp 1/2	12	510×680×1042	IP 32	57.9	115	2.0	16	230 V; 50 Hz	5.23	L003512	UC 4
133	5.3	26.6	Rp 1	35	720×910×1280	IP 54	61.0	150	3.8	25	400 V; 3/PE; 50 Hz	6.44	L002944	UC 8
130	4.0	26.6	Rp 1	35	720×910×1280	IP 54	61.0	150	3.4	25	400 V; 3/PE; 50 Hz / 460 V; 3/PE; 60 Hz	6.44	L002853	UC 8
133	5.3	43.8	Rp 1	35	720×910×1250	IP 54	64.7	175	5.4	25	400 V; 3/PE; 50 Hz	6.41	L002946	UC 14
130	3.7	43.8	Rp 1	35	720×910×1250	IP 54	64.7	175	5.1	25	400 V; 3/PE; 50 Hz / 460 V; 3/PE; 60 Hz	6.41	L002854	UC 14
200	4.9	84.1	Rp 1	35	720×910×1250	IP 54	64.7	180	9.5	32	400 V; 3/PE; 50 Hz	5.63	L002947	UC 24
130	2.7	84.1	Rp 1	35	720×910×1250	IP 54	64.7	180	8.0	32	400 V; 3/PE; 50 Hz / 460 V; 3/PE; 60 Hz	5.63	L002855	UC 24
250	5.5	150.0	Rp 1 1/2	210	1040×1435×1890	IP 54	68.7	410	16.5	50	400 V; 3/PE; 50 Hz	5.37	L002948	UC 50
230	3.3	150.0	Rp 1 1/2	210	1040×1435×1890	IP 54	68.7	410	14.8	50	400 V; 3/PE; 50 Hz / 460 V; 3/PE; 60 Hz	5.37	L002856	UC 50
367	6.5	196.0	Rp 1 1/2	210	1040×1435×1890	IP 54	69.5	440	23.6	63	400 V; 3/PE; 50 Hz	5.16	L002949	UC 65
250	3.3	196.0	Rp 1 1/2	210	1040×1435×1890	IP 54	69.5	440	20.4	63	400 V; 3/PE; 50 Hz / 460 V; 3/PE; 60 Hz	5.16	L002857	UC 65
420	3.4	247.0	Rp 2	300	1545×2230×2010	IP 54	58.3	1020	27.5	80	400 V; 3/PE; 50 Hz	-	E6080223	UC-0800
500	3.5	299.0	Rp 2 1/2	500	1660×3400×2090	IP 54	63.1	1460	33.4	100	400 V; 3/PE; 50 Hz	-	E6100221	UC-1000
500	4.5	392.0	Rp 2 1/2	500	1660×3400×2090	IP 54	62.2	1570	43.8	150	400 V; 3/PE; 50 Hz	-	E6135221	UC-1350
670	3.4	494.0	Rp 2 1/2	500	1660×3400×2090	IP 54	61.3	1630	54.9	150	400 V; 3/PE; 50 Hz	-	E6170221	UC-1700
970	3.6	733.0	DIN-2566 DN80	500	1660×3585×2090	IP 54	62.7	1690	71.4	200	400 V; 3/PE; 50 Hz	-	E6240221	UC-2400

LAUDA Circulation chillers

Power supply variants

Device type	Power supply V; Hz	Pump pressure max. bar	Pump flow max. pressure L/min	Loading max. kW	Plug code*	Part Number	Device type	Power supply V; Hz	Pump pressure max. bar	Pump flow max. pressure L/min	Loading max. kW	Plug code*	Part Number
LAUDA Microcool / Page 116													
MC 250	115 V; 60 Hz	0.4	16	0.2	14	L001066	MC 600	115 V; 60 Hz	1.3	35	0.8	14	L001068
MC 250	220 V; 60 Hz	0.4	16	0.2	43	L001061	MC 600	220 V; 60 Hz	1.3	35	0.7	43	L001063
MC 350	100 V; 50/60 Hz	0.4	16	0.5	14	L001072	MC 1200	115 V; 60 Hz	1.3	35	1.1	14	L001069
MC 350	115 V; 60 Hz	0.4	16	0.5	14	L001067	MC 1200	220 V; 60 Hz	1.3	35	1.2	43	L001064
MC 350	220 V; 60 Hz & 230 V; 50 Hz	0.4	16	0.5	42	L001052							
LAUDA Ultracool / Page 118													
UC 2	230 V; 60 Hz	3.5	50	1.1	-	L003513	UC-1000	460 V; 3/PE; 60 Hz	5.2	430	42.1	-	E6100241
UC 2	230 V; 60 Hz	5.0	80	1.3	-	L003533	UC-1350	460 V; 3/PE; 60 Hz	5.4	600	55.3	-	E6135241
UC 4	230 V; 60 Hz	3.5	50	1.9	-	L003514	UC-1700	460 V; 3/PE; 60 Hz	5.4	600	70.2	-	E6170241
UC 4	230 V; 60 Hz	5.0	80	2.1	-	L003534	UC-2400	460 V; 3/PE; 60 Hz	3.7	1170	96.1	-	E6240241
UC-0800	460 V; 3/PE; 60 Hz	4.8	300	35.4	-	E6080241							

*All data for the plug codes can be found on page 162

LAUDA Circulation chillers

More characteristics

LAUDA Ultracool / Page 118

PUMP CHARACTERISTIC Water

Pressure bar

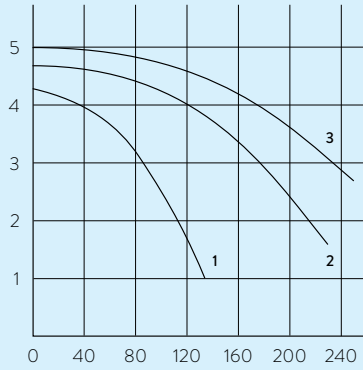

Pump flow L/min

- 3 UC 65
- 2 UC 50
- 1 UC 8, UC 14, UC 24

PUMP CHARACTERISTIC Water

Pressure bar

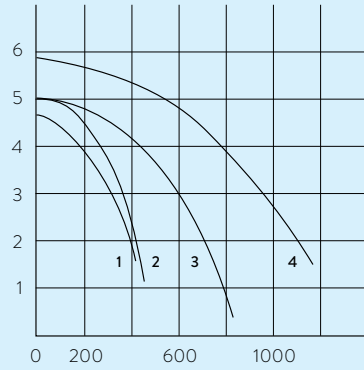

Pump flow L/min

- 1 UC-0800
- 2 UC-1000
- 3 UC-1350
- UC-1700
- 4 UC-2400

PUMP CHARACTERISTIC Water

Pressure bar

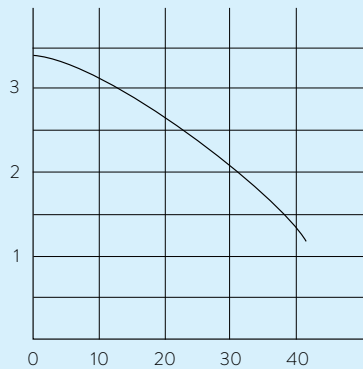

Flow rate L/min

- UC 2, UC 4

LAUDA CALIBRATION THERMOSTATS

Specific application examples

- Calibration of thermometers
- Validation of temperature sensors
- Quality testing heat meter



LAUDA ECO

Calibration and adjustment of temperatures from -25 to 200 °C with LAUDA calibration thermostats



High-performance comprehensive solution for calibration and adjustment

LAUDA calibration thermostats provide constant temperature and homogeneity in calibration and adjustment in the test chamber. Depending on the desired size, bath opening and usable depth, different types are available to choose from – each having variable testing chambers, as well as a comprehensive range of products and accessories. The ability of the thermostat to transfer heat through its heat transfer liquid 40 to 60 times better than through air makes it the perfect solution, especially in comparison to heating cabinets and metal block thermostats.

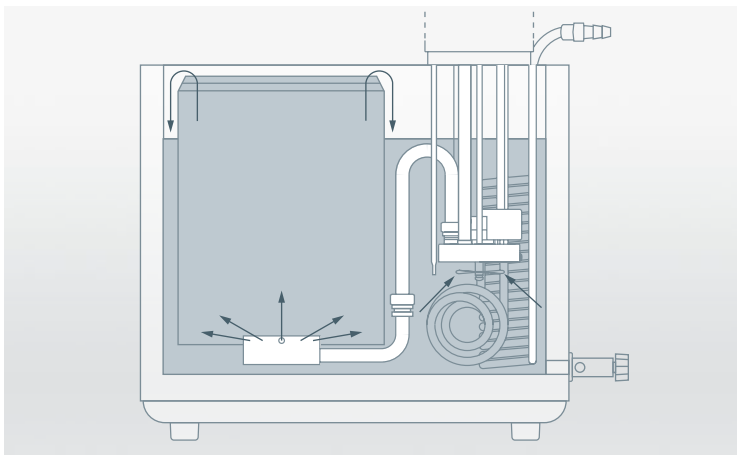

Constant immersion depth thanks to a calibration chamber with overflow principle



Simple operation via TFT display

COOLING PERFORMANCE Heat transfer liquid: Ethanol, bath closed

Bath temperature °C

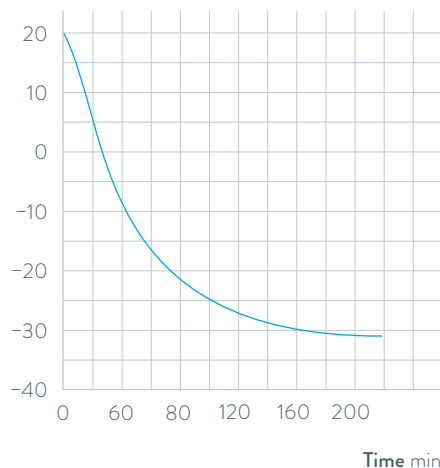

REJ1225 G

Important functions

- LAUDA Vario pump with six selectable output levels
- Vertical adjustment of the temperature chamber possible
- Stainless steel bath vessel (insulated, with handles and drain tap)
- USB interface as standard
- Programmer

Included accessories

Nipples, screw caps, bath cover

Further accessories

Calibration racks

All technical data and power supply variants can be found in the ›Technical data‹ section.

More at www.lauda.de/1772



LAUDA ECO

Temperature stabilities up to $\pm 0.02\text{K}$ at temperatures up to $-25\text{ }^\circ\text{C}$ are achieved with the LAUDA ECO calibration thermostats.



LAUDA Proline

Calibration and adjustment of temperatures from -40°C to 300°C with LAUDA calibration thermostats



High-performance comprehensive solution for calibration and adjustment

LAUDA calibration thermostats provide constant temperature and homogeneity in calibration and adjustment in the test chamber. Depending on the desired size, bath opening and usable depth, different types are available to choose from – each having variable testing chambers, as well as a comprehensive range of products and accessories.

* On request

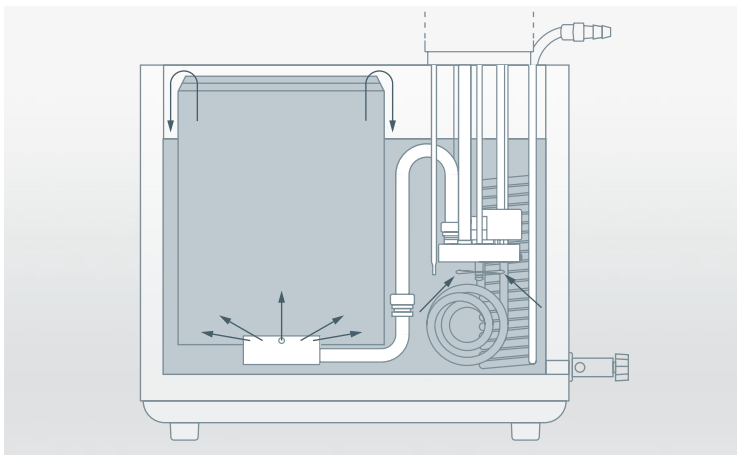

Constant immersion depth thanks to a calibration chamber with overflow principle



Removable remote control ›Command‹ for easy and intuitive operation

HEATING PERFORMANCE Heat transfer liquid: Ultra 240, bath closed

Bath temperature $^{\circ}\text{C}$

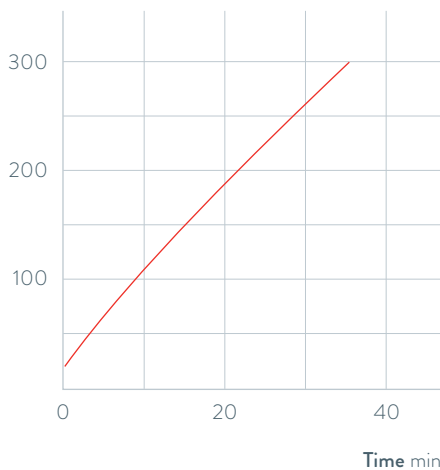

PJ 12/PJ 12 C
(up to 300°C)
PJL 12/PJL 12 C
(up to 200°C)

Important functions

- Stainless steel bath vessel (insulated, with handles and drain tap)
- Selectable Master control head with LED display or detachable Command operating unit with graphic LCD display
- LAUDA Vario Flex pump (pressure pump) with eight selectable output levels
- PowerAdapt system for optimally adapted max. heating output without influencing the mains power supply

Included accessories

Nipples, screw caps, bath cover

Further accessories

Calibration racks

All technical data and power supply variants can be found in the ›Technical data‹ section.

More at www.lauda.de/1774



LAUDA Proline

For maximum temperatures up to 300 °C, the compact models of the LAUDA Proline PJ12 and PJ12 C can be used.



LAUDA Calibration thermostats

Device type overview

LAUDA ECO / Page 132

LAUDA Proline / Page 134

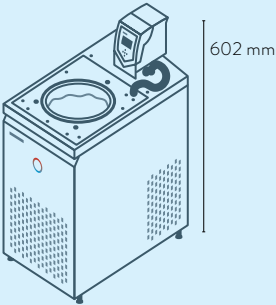

REJ 1225 G

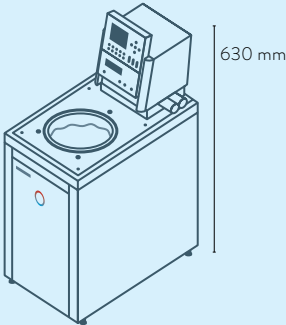

PJ 12 C
PJL 12 C

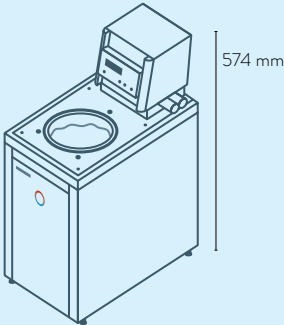

PJ 12
PJL 12

LAUDA Calibration thermostats

Interfaces

	Pt 100 (1)	Pt 100 (2)	USB	Ethernet	RS 232 / 485	Analog	Namur contact	D-Sub contact	PROFIBUS	EtherCAT M8	EtherCAT RJ 45	Malfunction contact	Number of module slots, large	Number of module slots, small
LAUDA ECO REJ 1225 G / Page 132	Z	-	S	Z	Z	Z	Z	-	Z	Z	Z	Z	1	1
LAUDA Proline Master / Page 134	S	-	-	Z	Z	Z	Z	Z	Z	Z	Z	-	2	-
LAUDA Proline Command / Page 134	S	-	-	Z	S	Z	Z	Z	Z	Z	Z	-	2	-

S = Series standard

Z = Available as an accessory



LRZ 912
Analog module



LRZ 913
RS 232/485
interface



LRZ 914
Contact module with single input
and single output (NAMUR)



LRZ 915
Contact module with
3 inputs and 3 outputs



LRZ 917
Profibus module



LRZ 918
Pt100/Li bus module,
small cover



LRZ 921
Ethernet module



LRZ 922
EtherCAT module
with M8 connection

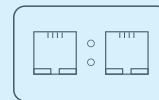

LRZ 923
EtherCAT module
with RJ45 connection



LRZ 925
External Pt100/LiBus-
module, large cover

LAUDA Calibration thermostats

Technical data according to DIN 12876 standard

Device type	Working temperature range °C	Operating temperature range °C	Temperature stability ±K	Safety fittings	Heater power max. kW	Cooling output kW					Pump type	Pump pressure max. bar	Pump flow max. pressure L./min	Pump connection thread mm
						20 °C	10 °C	0 °C	-10 °C	-20 °C				

LAUDA ECO / Page 132

REJ 1225 G	-25 ... 200	-25 ... 200	0.02	III, FL	2.6	0.30 ¹	-	0.24 ¹	-	0.09 ¹	V	0.6	22.0	M16 × 1
------------	-------------	-------------	------	---------	-----	-------------------	---	-------------------	---	-------------------	---	-----	------	---------

LAUDA Proline / Page 134

PJ 12	30 ... 300	0 ... 300	0.01	III, FL	3.6	-	-	-	-	-	V	0.8	25.0	M16 × 1
PJ 12 C	30 ... 300	0 ... 300	0.01	III, FL	3.6	-	-	-	-	-	V	0.8	25.0	M16 × 1
PJL 12	30 ... 200	-40* ... 200	0.01	III, FL	3.6	-	-	-	-	-	V	0.8	25.0	M16 × 1
PJL 12 C	30 ... 200	-40* ... 200	0.01	III, FL	3.6	-	-	-	-	-	V	0.8	25.0	M16 × 1

* On request

LAUDA Calibration thermostats

Power supply variants

Device type	Power supply V; Hz	Heater power max. kW	Loading max. kW	Plug code*	Part Number	Device type	Power supply V; Hz	Heater power max. kW	Loading max. kW	Plug code*	Part Number
-------------	--------------------	----------------------	-----------------	------------	-------------	-------------	--------------------	----------------------	-----------------	------------	-------------

LAUDA ECO / Page 132

REJ 1225 G	100 V; 50/60 Hz	1.0	1.3	14	L002851	REJ 1225 G	220 V; 60 Hz	2.4	2.7	3	L002852
REJ 1225 G	115 V; 60 Hz	1.3	1.4	14	L002849						

LAUDA Proline / Page 134

PJ 12	100 V; 50/60 Hz	1.3	1.5	4	L001947	PJL 12	100 V; 50/60 Hz	1.3	1.5	4	L001949
PJ 12	115 V; 60 Hz	1.7	1.9	4	L001937	PJL 12	115 V; 60 Hz	1.7	1.9	4	L001939
PJ 12	200 V; 50/60 Hz	2.7	2.9	3	L001951	PJL 12	200 V; 50/60 Hz	2.7	2.9	3	L001953
PJ 12	208-220 V; 60 Hz	3.3	3.5	3	L001943	PJL 12	208-220 V; 60 Hz	3.3	3.5	3	L001945
PJ 12 C	100 V; 50/60 Hz	1.3	1.5	4	L001948	PJL 12 C	100 V; 50/60 Hz	1.3	1.5	4	L001950
PJ 12 C	115 V; 60 Hz	1.7	1.9	4	L001938	PJL 12 C	115 V; 60 Hz	1.7	1.9	4	L001940
PJ 12 C	200 V; 50/60 Hz	2.7	2.9	3	L001952	PJL 12 C	200 V; 50/60 Hz	2.7	2.9	3	L001954
PJ 12 C	208-220 V; 60 Hz	3.3	3.5	3	L001944	PJL 12 C	208-220 V; 60 Hz	3.3	3.5	3	L001946

¹Pump output step 3

Nipples \varnothing_e	Bath volume min. L	Bath volume max. L	Bath opening \varnothing mm	Bath depth mm	Usable depth mm	Height top of bath mm	Dimensions (W x D x H) mm	Weight kg	Power supply V; Hz	Loading max. kW	Part Number	Device type
13	9.3	12.0	150	200	180	443	250×435×624	30.4	230 V; 50 Hz	2.9	L002848	REJ 1225 G
13	8.5	13.5	120	320	300	374	220×360×574	17.0	230 V; 50/60 Hz	3.7	L001923	PJ 12
13	8.5	13.5	120	320	300	374	220×360×630	17.0	230 V; 50/60 Hz	3.7	L001924	PJ 12 C
13	8.5	13.5	120	320	300	374	220×360×574	17.0	230 V; 50/60 Hz	3.7	L001925	PJL 12
13	8.5	13.5	120	320	300	374	220×360×630	17.0	230 V; 50/60 Hz	3.7	L001926	PJL 12 C

LAUDA DEEP-FREEZERS



Specific application examples

- Secure storage of organic substances, vaccines or reference strains of microorganisms
- Cold storage of enzymes and test kits in laboratories and hospitals
- Storage in pharmaceutical and chemical facilities
- Storage in pharmaceutical logistics centers



LAUDA Versafreeze

Freezing down to -86°C
with LAUDA freezer cabinets and chest freezers

-86°C  0°C

Tailor-made solutions for long-term and secure storage

Vaccines, organic substances and valuable samples that need to be stored at low temperatures are irreplaceable. Only the highest-quality deep-freezers guarantee long-term stability and availability in these challenging conditions. Based on decades of experience and technical development, LAUDA has optimized its Versafreeze deep-freezers for the extreme conditions of ultra deep-freeze storage and set new standards.



High-performance operating unit with password-protected user management



Flexible loading options for optimum utilization of the usable volume



Insulation (from right to left):
Interior with stainless steel walls, tightly
meshed evaporator, thermal film, vacuum
panels, impermeable foam, appliance front

Powerful insulation technology with high-quality materials

Important functions

- Intuitive operation via touch screen, integrated data logger, password-protected access rights
- The multi-layered high-performance vacuum insulation protects against loss of coldness and minimizes the energy consumption of continuous operation
- Options: CO_2 or LN_2 safety cooling system, water cooling, set of drawers for freezer cabinets, factory certificate

Included accessories

Two feedthroughs $\varnothing 13$ mm, for incorporating additional control or alarm sensors, Ethernet RJ45 connection

Further accessories

Storage system/plug-in units, boxes, grid segmentations, external data logger

All technical data and power supply variants can be found in the ›Technical data‹ section.

More at www.lauda.de/1774



LAUDA Versafreeze

LAUDA Versafreeze appliances offer the greatest possible security for your samples, even in a power cut, thanks to long defrosting times. The integrated accumulator is a standard feature and ensures that the display and alarm functions are maintained for a period of up to 35 hours.



LAUDA Deep-freezers

Device type overview

LAUDA Versafreeze Chest freezers / Page 142

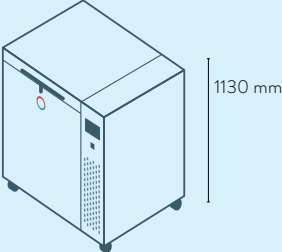

VF 20040
VF 20085

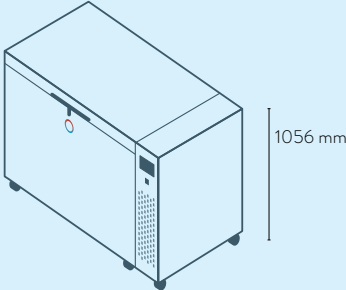

VF 55040
VF 55085

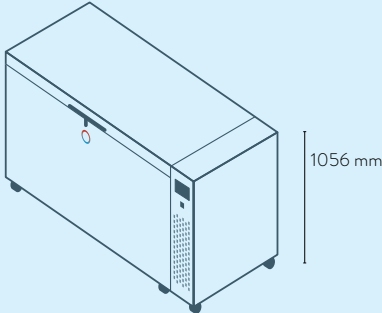

VF 75040
VF 75085

LAUDA Versafreeze Upright freezers / Page 142

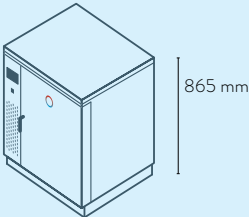

VF 15040
VF 15085

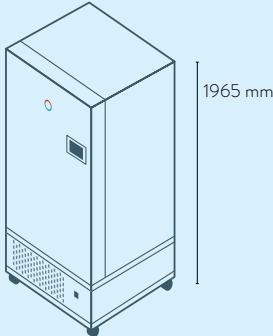

VF 60040
VF 60085

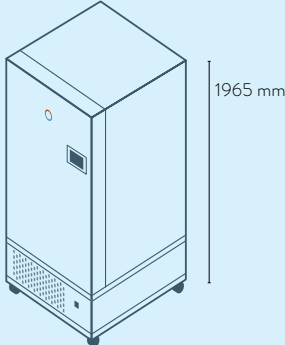

VF 70040
VF 70085

LAUDA Deep-freezers

Technical data

Device type	Usable volume L	Temperature range	Cooling time to -80 °C / -40 °C h (without load)	Warm-up time -80 °C / -40 °C to 0 °C h (without load)	Interior dimensions (W x D x H) mm	External dimensions (W x D x H) mm	Net weight kg	Capacity 50 mm cryoboxes	Part number
Chest freezers / Page 142									
VF 20040 C	205	-40 ... 0 °C	3	6	790×520×500	960×790×1130	188	135	L003335
VF 55040 C	556	-40 ... 0 °C	4	10	1180×620×760	1671×910×1056	260	416	L003336
VF 75040 C	754	-40 ... 0 °C	5	10	1600×620×760	2102×910×1056	310	572	L003337
VF 20085 C	205	-86 ... -50 °C	3	11	790×520×500	960×790×1130	210	135	L003338
VF 55085 C	556	-86 ... -50 °C	4	19	1180×620×760	1671×910×1056	280	416	L003339
VF 75085 C	754	-86 ... -50 °C	5	19	1600×620×760	2102×910×1056	332	572	L003340
Upright freezers / Page 142									
VF 15040	129	-40 ... 0 °C	5	12	480×480×560	904×776×865	128	81	L003341
VF 60040	583	-40 ... 0 °C	6	17	738×600×1320	980×956×1965	334	420	L003342
VF 70040	731	-40 ... 0 °C	7	13	738×750×1320	980×1165×1965	345	525	L003343
VF 15085	129	-86 ... -50 °C	5	18	480×480×560	904×776×865	162	81	L003344
VF 60085	583	-86 ... -50 °C	6	27	738×600×1320	980×956×1965	356	420	L003345
VF 70085	731	-86 ... -50 °C	7	25	738×750×1320	980×1165×1965	370	525	L003346

Power supply: 230 V; 50 Hz; Electrical connection: CEE7/7 angled, (EU, Schuko)

Other voltage and plug variants available.

LAUDA SHAKERS



Specific application examples

- Biology and microbiology
- Medical diagnostics
- Analytical laboratories
- Testing institutes, universities and research facilities
- Quality assurance laboratories



UDA



Control panel with a digital display showing '50', a power button, and navigation arrows. The text 'GFL Technology' is visible below the display.

LAUDA Varioshake

Shakers and shaking incubators
in many variants for every application

Orbital, linear, tumbling, rocking and overhead shaking

With the new Varioshake shakers, LAUDA is expanding its product range of reliable laboratory devices for a comprehensive range of application. Like the new LAUDA Hydro water baths, the Varioshake shakers bear the ›GFL Technology‹ quality mark and represent the many years of experience and outstanding quality of the premium manufacturer GFL Gesellschaft für Labortechnik. With the modern LAUDA design and excellent performance data, the new LAUDA laboratory devices are a byword for premium quality and precision.



A comprehensive range of accessories ensures high flexibility and provides solutions for a large number of laboratory applications



With digital or analog controls – intuitive and easy to operate



Varioshake VS 60 OI – compact, economic, powerful

Important functions

- The digitally controlled shakers provide an extended timer range with a stop function and reproducibility by saving the most recent operating parameters
- The analog-controlled models have an extended operating temperature range up to 60 °C

Further accessories

Shaking trays, adhesive mats, non-slip support, test tube racks, clamps for flasks/separating funnels, universal attachments

All technical data and power supply variants can be found in the ›Technical data‹ section.

More at www.lauda.de/1774



LAUDA Varioshake

The LAUDA Varioshake product line comprises ten shakers in three sizes with five different shaking motions, as well as three shaking incubators in three sizes with a circular motion.



LAUDA Shakers

Device type overview

LAUDA Varioshake Shakers / Page 148

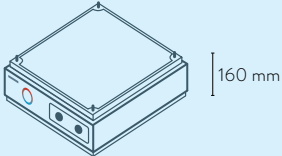

VS 8 OE
VS 8 BE

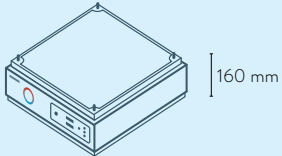

VS 8 O
VS 8 B

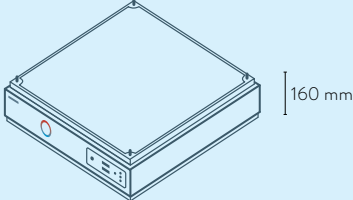

VS 15 O
VS 15 B
VS 15 R
VS 15 T

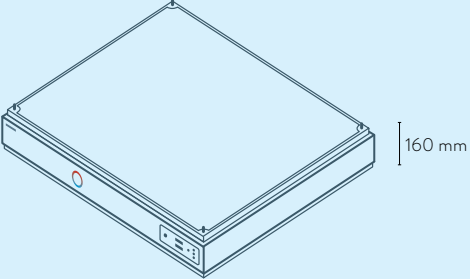

VS 30 O

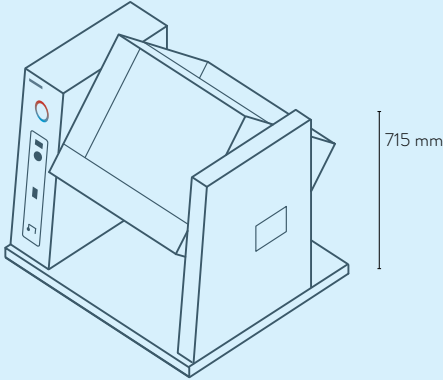

VS 20 OH

LAUDA Varioshake Shaking incubators / Page 148

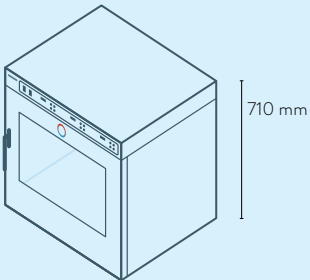

VS 45 OI

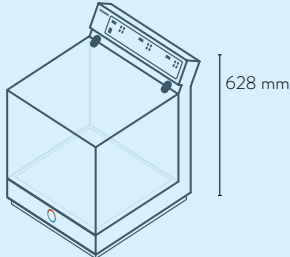

VS 60 OI

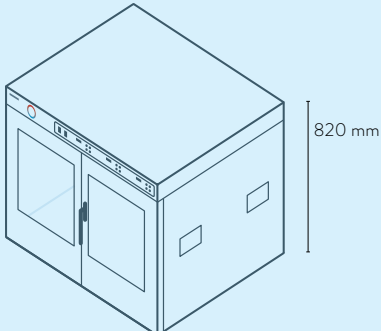

VS 150 OI

LAUDA Shakers

Technical data

Device type	Ambient temperature °C	Size of moving table mm	Max. load bearing capacity kg	Shaking amplitude mm	Tumbling/rocking amplitude °	Shaking frequency rpm	Movement type**	Dimensions (W x D x H) mm	Weight kg	Power supply V; Hz	Max. power consumption kW	Part Number
Shakers / Page 148												
VS 8 OE*	10 ... 60	330 x 330	8	10	-	20 ... 500	O	350 x 375 x 160	11.0	230 V; 50/60 Hz	0.07	L003055
VS 8 BE*	10 ... 60	330 x 330	8	20	-	20 ... 300	B	350 x 375 x 160	11.0	230 V; 50/60 Hz	0.07	L003056
VS 8 O	10 ... 50	330 x 330	8	10	-	20 ... 500	O	350 x 355 x 160	11.0	230 V; 50/60 Hz	0.07	L003057
VS 8 B	10 ... 50	330 x 330	8	20	-	20 ... 300	B	350 x 355 x 160	11.0	230 V; 50/60 Hz	0.07	L003058
VS 15 O	10 ... 50	450 x 450	15	30	-	20 ... 300	O	480 x 487 x 160	19.5	230 V; 50/60 Hz	0.07	L003061
VS 15 B	10 ... 50	450 x 450	15	30	-	20 ... 300	B	480 x 487 x 160	19.5	230 V; 50/60 Hz	0.07	L003062
VS 15 R	10 ... 50	450 x 450	15	-	3	2 ... 50	R	480 x 487 x 160	19.5	230 V; 50/60 Hz	0.09	L003060
VS 15 T	10 ... 50	450 x 450	15	-	3	2 ... 50	T	480 x 487 x 160	19.5	230 V; 50/60 Hz	0.09	L003059
VS 30 O	10 ... 50	676 x 540	30	32	-	20 ... 250	O	705 x 607 x 160	34.0	230 V; 50/60 Hz	0.09	L003063
VS 20 OH	10 ... 40	-	20	-	-	1 ... 20	OH	770 x 700 x 715	62.0	230 V; 50/60 Hz	0.10	L003064

VS 8 O to VS 30 O shakers with RS232 interface as an option

Device type	Working temperature range °C	Temperature stability ±K	Max. heating output kW	Chamber dimensions mm	Chamber volume L	Max. load bearing capacity kg	Shaking amplitude mm	Shaking frequency rpm	Movement type**	Dimensions (W x D x H) mm	Weight kg	Power supply V; Hz	Max. power consumption kW	Part Number
Shaking incubators / Page 148														
VS 60 OI ¹	28 ... 70	0.20	0.5	450 x 450 x 338	68	12	30	20 ... 250	O	559 x 687 x 628	41.5	230 V; 50/60 Hz	0.80	L003052
VS 45 OI ²	28 ... 70	0.20	0.5	420 x 270 x 320	45	12	25	20 ... 250	O	710 x 650 x 710	70.0	230 V; 50/60 Hz	0.80	L003053
VS 150 OI ³	28 ... 70	0.20	0.5	674 x 540 x 430	150	20	25	20 ... 250	O	930 x 890 x 820	135.0	230 V; 50/60 Hz	0.80	L003054

All shaking incubators, including RS232 interface as standard

* OE*/BE* = with analog control

¹ with acrylic cover

² with one front door

³ with two front doors

** Movement type:

O = orbital

B = bi-directional / Linear

R = rockers

T = tumble

OH = overhead



LAUDA STILLS



Specific application examples

- Bacteriological and medical sample preparation
- Preparation of cell and tissue cultures
- Cleaning and sterilization processes
- Production of buffer solutions in quality, development and research laboratories
- Microbiological and analytical applications



LAUDA Puridest

Stills in a large number of variants –
the perfect solution for every application

High distillate quality – with the ›GFL Technology‹ quality mark

LAUDA Puridest stills provide ultra-pure, low-gas, sterile and pyrogen-free distillate for the dilution of reagents, sets of samples and more. LAUDA Puridests purify any raw water to produce a distillate with conductivities down to below $1.6 \mu\text{S}/\text{cm}$. It complies with DAB regulations and the international pharmacopeia requirements.



Our maxim is simplicity: LED indicators for operating status and cleaning requirement are equipped as standard



Equipped for any application: Puridest PD 4 D for the direct distillate extraction of mono- or bi-distillate



Puridest PD 4 DG

Important functions

- Device protected by water shortage protection in all models
- Energy savings through distillation of the heated cooling water
- Devices only require power and raw water
- Expensive cartridges, adsorbents and regular regeneration of ion exchangers can be dispensed with

Further accessories

Prefilter, dechlorite filter, phosphate cartridge, replacement cartridge, wall mounting, hose sets

Devices with options such as ›Separate water supply‹ or ›External level controller‹ on request.

All technical data and power supply variants can be found in the ›Technical data‹ section.

More at www.lauda.de/1774



LAUDA Puridest

Decades of experience and technical development have set the standard: LAUDA Puridest stills are offered worldwide in four high-performance product lines with 14 model variants.



LAUDA Stills

Device type overview

LAUDA Puridest / Page 154

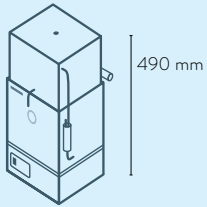

PD 2
PD 4

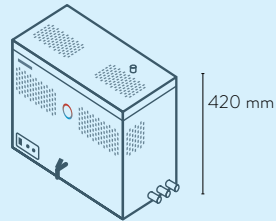

PD 2 R

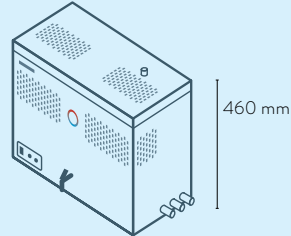

PD 4 R

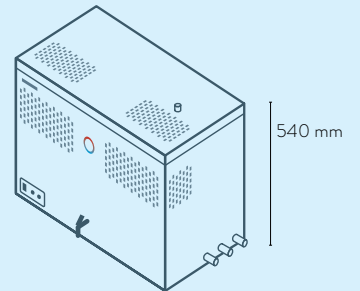

PD 8 R

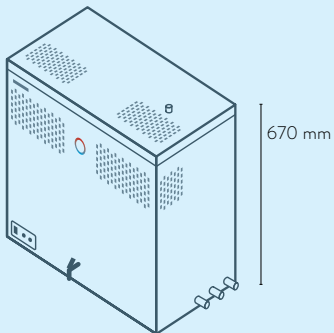

PD 12 R

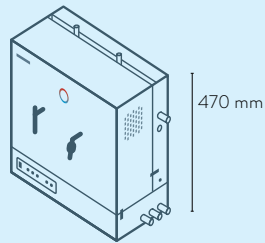

PD 2 D

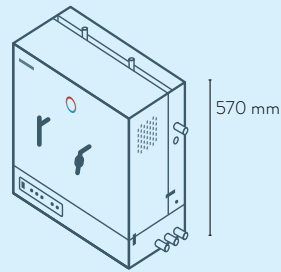

PD 4 D

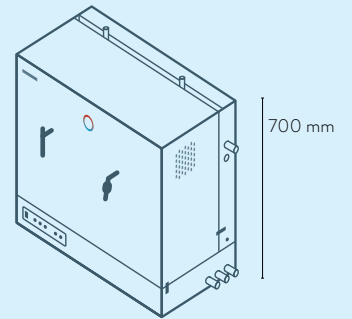

PD 8 D

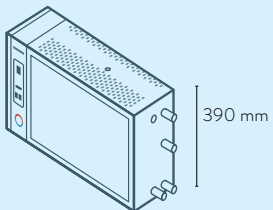

PD 2 G
PD 4 G

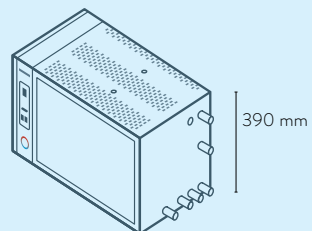



PD 2 DG
PD 4 DG
PD 8 G

LAUDA Stills

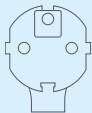
Technical data

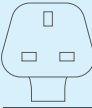
Device type	Ambient temperature °C	Distillate type	Condenser material	Production output l/h	Conductivity stage 1* approx. µS/cm	Conductivity stage 2* approx. µS/cm	Tank volume l	Cooling water consumption l/min	Dimensions (W x D x H) mm	Weight kg	Mains voltage	Max. power consumption kW	Part Number
 CEE7/7 plug, angled, "Schuko" type													
PD 2	10 ... 40	Mono	Stainless steel	2	2.3	-	-	0.33	280 × 250 × 490	7.5	230 V; 50/60 Hz	2.00	L003011
PD 4	10 ... 40	Mono	Stainless steel	4	2.3	-	-	0.67	280 × 250 × 490	7.5	230 V; 50/60 Hz	3.00	L003012
PD 2 R	10 ... 40	Mono	Stainless steel	2	2.3	-	4	0.5	540 × 290 × 420	15.4	230 V; 50/60 Hz	1.50	L003013
PD 4 R	10 ... 40	Mono	Stainless steel	4	2.3	-	8	0.8	620 × 330 × 460	21.4	230 V; 50/60 Hz	3.00	L003014
PD 2 G	10 ... 40	Mono	Glass	2	2.2	-	-	0.8	650 × 200 × 390	16.0	230 V; 50/60 Hz	1.50	L003017
PD 4 G	10 ... 40	Mono	Glass	4	2.2	-	-	1.2	650 × 200 × 390	17.0	230 V; 50/60 Hz	3.00	L003018
PD 2 D	10 ... 40	Double	Stainless steel/Glass	2	2.2	1.6	-	1.2	500 × 260 × 470	21.0	230 V; 50/60 Hz	3.50	L003020
PD 2 DG	10 ... 40	Double	Glass	2	2.2	1.6	-	1.2	650 × 365 × 390	24.0	230 V; 50/60 Hz	2.90	L003023

 BS1363 plug, angled (UK)													
PD 2	10 ... 40	Mono	Stainless steel	2	2.3	-	-	0.33	280 × 250 × 490	7.5	230 V; 50/60 Hz	2.00	L003219
PD 2 R	10 ... 40	Mono	Stainless steel	2	2.3	-	4	0.5	540 × 290 × 420	15.4	230 V; 50/60 Hz	1.50	L003220
PD 2 G	10 ... 40	Mono	Glass	2	2.2	-	-	0.8	650 × 200 × 390	16.0	230 V; 50/60 Hz	1.50	L003221

 IEC 60309 plug, 5-pole, CEE, red, 16 A													
PD 8 R	10 ... 40	Mono	Stainless steel	8	2.3	-	16	1.2	780 × 410 × 540	35.3	400 V; 3/N/PE; 50/60 Hz	6.00	L003015
PD 12 R	10 ... 40	Mono	Stainless steel	12	2.3	-	24	3.3	780 × 410 × 670	40.5	400 V; 3/N/PE; 50/60 Hz	9.00	L003016
PD 8 G	10 ... 40	Mono	Glass	8	2.2	-	-	2.4	650 × 365 × 390	24.0	400 V; 3/N/PE; 50/60 Hz	6.00	L003019
PD 4 D	10 ... 40	Double	Stainless steel/Glass	4	2.2	1.6	-	2	550 × 280 × 570	27.5	400 V; 3/N/PE; 50/60 Hz	7.00	L003021
PD 8 D	10 ... 40	Double	Stainless steel/Glass	8	2.2	1.6	-	3.3	700 × 390 × 700	45.0	400 V; 3/N/PE; 50/60 Hz	11.50	L003022
PD 4 DG	10 ... 40	Double	Glass	4	2.2	1.6	-	2.4	650 × 365 × 390	24.0	400 V; 3/N/PE; 50/60 Hz	5.80	L003024

 Cable without plug													
PD 8 R	10 ... 40	Mono	Stainless steel	8	2.3	-	16	1.2	780 × 410 × 540	35.3	220 V; 3/PE; 50/60 Hz	6.00	L003115
PD 12 R	10 ... 40	Mono	Stainless steel	12	2.3	-	24	3.3	780 × 410 × 670	40.5	220 V; 3/PE; 50/60 Hz	9.00	L003116
PD 8 G	10 ... 40	Mono	Glass	8	2.2	-	-	2.4	650 × 365 × 390	24.0	220 V; 3/PE; 50/60 Hz	6.00	L003117
PD 4 D	10 ... 40	Double	Stainless steel/Glass	4	2.2	1.6	-	2	550 × 280 × 570	27.5	220 V; 3/PE; 50/60 Hz	7.00	L003118
PD 8 D	10 ... 40	Double	Stainless steel/Glass	8	2.2	1.6	-	3.3	700 × 390 × 700	45.0	220 V; 3/PE; 50/60 Hz	11.50	L003119
PD 4 DG	10 ... 40	Double	Glass	4	2.2	1.6	-	2.4	650 × 365 × 390	24.0	220 V; 3/PE; 50/60 Hz	5.80	L003120

* The quality of the conductivity depends on the selected model and raw water quality

LAUDA Heat transfer liquids

For safe and reliable operation of your thermostats

Highly accurate temperature control at extreme temperatures, reliability and long-term operational stability for a long service life of the thermostats.

The right choice of heat transfer liquid is of critical importance for the safe and reliable operation of thermostats, circulation chillers or water baths. Thanks to our many decades of experience, we are able to offer optimum heat transfer liquids for LAUDA thermostats and other brands. Prices of heat transfer liquids can be found in our price list, which we will gladly send you on request.

Designation	Open / half-open systems °C						Closed systems with cold oil overlay (Integral XT) °C						Part Number 5L/10L/20L
	-100 °C	-50 °C	0 °C	100 °C	200 °C	300 °C	-100 °C	-50 °C	0 °C	100 °C	200 °C	300 °C	
Aqua 90			5 °C		90 °C								LZB 120/LZB 220/LZB 320
Kryo 95 Silicone oil	-95 °C				60 °C		-95 °C					160 °C	LZB 130/LZB 230/LZB 330
Kryo 70 Silicone oil							-70 °C					220 °C	LZB 127/LZB 227/LZB 327
Kryo 65							-65 °C					140 °C	LZB 118/LZB 218/LZB 318
Kryo 60 Silicone oil		-60 °C			60 °C								LZB 102/LZB 202/LZB 302
Kryo 51 Silicone oil		-50 °C											LZB 121/LZB 221/LZB 321
Kryo 30			-30 °C			90 °C			-30 °C			90 °C	LZB 109/LZB 209/LZB 309
Kryo 20 Silicone oil			-20 °C										LZB 116/LZB 216/LZB 316
Therm 160				60 °C									LZB 106/LZB 206/LZB 306
Therm 180 Silicone oil			0 °C										LZB 114/LZB 214/LZB 314
Therm 250 Silicone oil				50 °C									LZB 122/LZB 222/LZB 322
Ultra 350				30 °C					30 °C				LZB 107 / - / -

Note: LAUDA Integral P may only be operated with non-combustible media (Kryo 30).
The temperature range of Kryo 30 is extended from -40 to 140 °C here.

Request the comprehensive LAUDA heat transfer liquid brochure at info@lauda.de

More at www.lauda.de/1782



LAUDA Accessories

Individual solutions, down to the finest detail

Tailored to your requirements

It makes no difference whether it concerns an optimized sample holder, improved handling or storage, mechanical accessories facilitate the daily temperature control, shaking or cultivating work. A wide variety of hose material in various cross-sections, optimized for the temperature range or also insulated as needed is the basis for the hydraulic connection of constant temperature equipment to applications. Adapters, distributors and taps provide flexibility. Remote controls, interfaces and through-flow control systems individually extend the connectivity, the range of functions and the operating convenience.

Electrical and electronic accessories:

- Flow controllers
- Flow control instruments
- Remote controls
- Solenoid valves
- Interface modules
- Temperature sensors
- Connecting cables and sockets



Hose material:

- Hose sets
- Polymer hoses
- Corrugated metal hoses
- Insulating hoses



Hydraulic components:

- Shut-off valves
- Adapters and fittings
- Cooling coils and heat exchangers
- Filter systems
- Distributors



Mechanical accessories:

- Bath covers
- Bath vessels
- Fastening components and mounts
- Boxes and baskets
- Racks
- Rising platforms
- Platforms
- Trays



Consumables:

- Filter cartridges



Documentation:

- Certificates

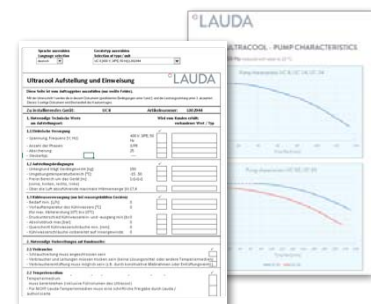

Request the comprehensive LAUDA accessories brochure at info@lauda.de

More at www.lauda.de/1784



LAUDA Accessories

LAUDA components, like the flow control unit MID 80, offer you the fitting complement to your application – from very small to very large. Therefore you can easily personalize your application and meet every requirement – in the usual LAUDA quality.

Power plugs

Overview

Image	Plug code	Description	Image	Plug code	Description	Image	Plug code	Description
	2	CEE7/7 angled (EU, Schuko)		3	NEMA 6-20P (USA)		4	NEMA 5-20P (USA)
	5	GB2099 (CN)		6	BS1363 angled (UK)		7	IEC 60309, (blue), ›Caravan
	8	SEV 1011, SEV 5934/2 (CH, T23)		9	AS/NSZ 3112 (AUS)		10	NBR 14136 (BR)
	14	NEMA 5-15P (USA)		17	CEE7/7 straight (EU, Schuko)		21	IEC 60309, 5-pin, CEE, red, 16 A
	22	IEC 60309, 5-pin, CEE, red, 32 A		23	IEC 60309, 5-pin, CEE, red, 63 A		25	NEMA 5-15P (Japan)
	26	SEV 1011, SEV 5934/2 (CH, T12)		31	Mains cable without plug (HAR), Harmonized cable (DIN VDE 0281/DIN VDE 0282/DIN VDE 0292)		32	Mains cable without plug (AWG), American Wire Gauge, abbreviation AWG
	33	NEMA L16-30P twist lock; 30 A 480 V; 30 A, 3L+N+PE		34	NEMA L16-20P twist lock; 20 A 480 V; 20 A, 3L+N+PE		35	AS/NSZ 3112, SAA/3 (AUS) Australia, 250 V; 10 A
	36	NEMA 6-15P (USA) USA, 250 V; 15 A		37	NBR 14136, BR/3 (BR) Brazil, 250 V; 10 A		38	NEMA L15-30P twist lock; 30 A USA, 250 V; 30 A, 3L+PE
	40	NEMA L15-20P twist lock; 20 A USA, 250 V; 20 A, 3L+PE		42	Two mains cables with socket 6 and 8		43	Two mains cables with socket 6 and 17

