

Operating Manual

VDL (E2.1)

Vacuum drying ovens for flammable solvents

with microprocessor program controller RD3

Model	Model version	Art. No.
VDL 23	VDL023-230V	9030-0038, 9130-0038
VDL 53	VDL053-230V	9030-0039, 9130-0039
VDL 115	VDL115-230V	9030-0040, 9130-0040

BINDER GmbH

Address	Post office box 102 D-78502 Tuttlingen
Tel.	+49 7462 2005 0
Fax	+49 7462 2005 100
Internet	http://www.binder-world.com
E-mail	info@binder-world.com
Service Hotline	+49 7462 2005 555
Service Fax	+49 7462 2005 93 555
Service E-Mail	service@binder-world.com
Service Hotline USA	+1 866 885 9794 or +1 631 224 4340 x3
Service Hotline Asia Pacific	+852 390 705 04 or +852 390 705 03
Service Hotline Russia and CIS	+7 495 98815 16

Contents

1. SAFETY	5
1.1 Legal considerations	5
1.2 Structure of the safety instructions.....	5
1.2.1 Signal word panel	5
1.2.2 Safety alert symbol	6
1.2.3 Pictograms	6
1.2.4 Word message panel structure.....	7
1.3 Localization / position of safety labels on the chamber	7
1.4 Type plate	8
1.5 General safety instructions on installing and operating the vacuum drying oven	9
1.5.1 Safety instructions on installation and ambient conditions	10
1.5.2 Safety instructions on vacuum supply	11
1.5.3 Safety instructions on the charging material.....	12
1.5.4 Safety instructions on operating the vacuum drying oven.....	14
1.6 Intended use	17
1.6.1 Operation log	17
2. DESCRIPTION OF THE EQUIPMENT	19
2.1 Safety equipment	20
2.2 Overview of the oven	21
2.3 VDL control panel.....	22
2.4 Connections at the rear of the chamber	23
2.5 "Temperature setting" information panel (ignition temperature vs. drying temperature).....	24
2.6 Overview of the zone classification of the ovens.....	25
3. COMPLETENESS OF DELIVERY, TRANSPORTATION, STORAGE, AND INSTALLATION	27
3.1 Unpacking, and checking equipment and completeness of delivery.....	27
3.2 Guidelines for safe lifting and transportation	28
3.3 Storage.....	28
3.4 Location of installation and ambient conditions	28
4. INSTALLATION AND CONNECTIONS	30
4.1 Vacuum expansion racks.....	30
4.2 Vacuum connection	31
4.2.1 Notes regarding use of vacuum pumps of other manufacturers	33
4.3 Inert gas connection.....	33
4.4 Compressed air / inert gas connection for sweeping the area for electrical equipment.....	34
4.5 Electrical connection	35
5. START UP	36
5.1 Settings at the RD3 program controller	36
5.2 General indications	37
6. FIXED VALUE ENTRY MODE	39
7. WEEK PROGRAM EDITOR	41
7.1 Program table template for the Week Program Editor.....	43
7.2 Programming example of the Week program editor.....	44
7.2.1 Desired time function	44
7.2.2 Proceeding overview	44
7.2.3 Proceeding in detail	45

8.	PROGRAM EDITOR	50
8.1	Selecting between set-point ramp and set-point step	50
8.1.1	Programming with setting "Ramp" (default setting)	50
8.1.2	Programming with setting "step"	53
8.1.3	General notes on programming temperature transitions	54
8.2	Set-point entry for program operation	54
8.3	Program table template	57
8.4	Deleting a program section	58
9.	PROGRAM START LEVEL	59
10.	USER LEVEL	62
11.	PERFORMANCE IN CASE OF FAILURES	68
11.1	Performance after power failures	68
11.2	Alarm messages	68
12.	SAFETY DEVICE CLASS 2 (DIN 12880:2007)	68
13.	REFERENCE MEASUREMENTS. CHECKING THE TEMPERATURE IN THE INNER CHAMBER	70
14.	COMMISSIONING THE VACUUM	70
14.1	Evacuation	71
14.2	Breaking the vacuum (flooding with ambient air)	71
14.3	Operation with inert gas	71
15.	OPTIONS	72
15.1	ATEX connection kits for vacuum pumps VP4 or VP5 (option)	72
15.2	Vacuum module empty (without pump) (option)	73
15.3	Vacuum module with chemical membrane pump VP4 or VP5 (option)	75
15.4	Additional measuring channel for digital object temperature display with flexible Pt 100 temperature sensor (option)	78
15.5	Measuring access port vacuum 9 poles (option)	80
15.6	Communication software APT-COM™ 3 DataControlSystem (option)	80
16.	MAINTENANCE, CLEANING, AND SERVICE	81
16.1	Maintenance intervals, service	81
16.2	Cleaning and decontamination	82
16.2.1	Cleaning	82
16.2.2	Decontamination	83
16.3	Sending the chamber back to BINDER GmbH	85
17.	DISPOSAL	85
17.1	Disposal of the transport packing	85
17.2	Decommissioning	86
17.3	Disposal of the chamber in the Federal Republic of Germany	86
17.4	Disposal of the chamber in the member states of the EC except for the Federal Republic of Germany	87
17.5	Disposal of the chamber in non-member states of the EC	89
18.	TROUBLESHOOTING	89
19.	TECHNICAL DESCRIPTION	91
19.1	Factory calibration and adjustment	91
19.2	Technical data	91



19.3	Equipment and options (extract).....	93
19.4	Accessories and spare parts (extract).....	94
19.5	Dimensions VDL 23.....	95
19.6	Dimensions VDL 53.....	96
19.7	Dimensions VDL 115.....	97
20.	CERTIFICATES AND DECLARATIONS OF CONFORMITY.....	98
20.1	EU Declaration of Conformity.....	98
20.2	TÜV Certificate.....	101
21.	PRODUCT REGISTRATION.....	102
22.	CONTAMINATION CLEARANCE CERTIFICATE.....	103
22.1	For chambers located outside USA and Canada.....	103
22.2	For chambers located in USA and Canada.....	106

Dear customer,

For the correct operation of the program controlled vacuum drying oven VDL, it is important that you read this operating manual completely and carefully and observe all instructions as indicated. Failure to read, understand and follow the instructions may result in personal injury. It can also lead to damage to the chamber and/or poor equipment performance.

1. Safety

This operating manual is part of the components of delivery. Always keep it handy for reference. The device should only be operated by laboratory personnel especially trained for this purpose, familiar with all precautionary measures required for working in a laboratory and having a basic knowledge of explosion protection (ATEX training). Observe the national regulations on minimum age of laboratory personnel. To avoid injuries and damage observe the safety instructions of the operating manual.

	 WARNING
<p>Failure to observe the safety instructions. Serious injuries and chamber damage.</p> <ul style="list-style-type: none">➤ Observe the safety instructions in this operating manual.➤ Carefully read the complete operating instructions of the VDL vacuum drying oven.	

1.1 Legal considerations

This operating manual is for informational purposes only. It contains information for installing, start-up, operation and maintenance of the product. Note: the contents and the product described are subject to change without notice.

Understanding and observing the instructions in this operating manual are prerequisites for hazard-free use and safety during operation and maintenance. In no event shall BINDER be held liable for any damages, direct or incidental arising out of or related to the use of this manual.

This operating manual cannot cover all conceivable applications. If you would like additional information, or if special problems arise that are not sufficiently addressed in this manual, please ask your dealer or contact us directly by phone at the number located on page one of this manual

Furthermore, we emphasize that the contents of this operating manual are not part of an earlier or existing agreement, description, or legal relationship, nor do they modify such a relationship. All obligations on the part of BINDER derive from the respective purchase contract, which also contains the entire and exclusively valid statement of warranty administration. The statements in this manual neither augment nor restrict the contractual warranty provisions.

Have repairs performed only by experts authorized by BINDER. Repaired chambers must comply with the quality standard specified by BINDER.

1.2 Structure of the safety instructions

In this operating manual, the following safety definitions and symbols indicate dangerous situations following the harmonization of ISO 3864-2 and ANSI Z535.6.

1.2.1 Signal word panel

Depending on the probability of serious consequences, potential dangers are identified with a signal word, the corresponding safety color, and if appropriate, the safety alert symbol.

 **DANGER**

Indicates an imminently hazardous situation that, if not avoided, will result in death or serious (irreversible) injury.

 **WARNING**

Indicates a potentially hazardous situation which, if not avoided, could result in death or serious (irreversible) injury.

 **CAUTION**

Indicates a potentially hazardous situation which, if not avoided, may result in moderate or minor (reversible) injury.

CAUTION

Indicates a potentially hazardous situation, which, if not avoided, may result in damage to the product and/or its functions or to property in its proximity.











1.2.2 Safety alert symbol













Use of the safety alert symbol indicates a **risk of injury**.

Observe all measures that are marked with the safety alert symbol in order to avoid death or injury.

1.2.3 Pictograms

Warning signs			
 Electrical hazard	 Hot surface	 Explosive atmosphere	 Stability hazard
 Lifting hazard	 Inhalation hazard	 Suffocation hazard	 Harmful substances
 Biohazard	 Risk of corrosion and / or chemical burns	 Pollution Hazard	

Mandatory action signs			
 Mandatory regulation	 Read operating instructions	 Disconnect the power plug	 Lift with several persons
 Environment protection	 Wear protective gloves	 Wear eye protectors	
Prohibition signs			
 Do NOT touch	 Do NOT spray with water		
	Information to be observed in order to ensure optimum function of the product.		

1.2.4 Word message panel structure

<p>Type / cause of hazard.</p> <p>Possible consequences.</p> <ul style="list-style-type: none"> ∅ Instruction how to avoid the hazard: prohibition ➤ Instruction how to avoid the hazard: mandatory action
--

Observe all other notes and information not necessarily emphasized in the same way, in order to avoid disruptions that could result in direct or indirect injury or property damage.

1.3 Localization / position of safety labels on the chamber

The following labels are located on the chamber:



Pictograms (Warning signs)	Service label
 <p>Hot surface</p>	 <p>Service - Hotline</p> <p>International: + 49 (0) 7462 / 2005-555 USA Toll Free: + 1 866 885 9794 or: + 1 631 224 4340 Россия и СНГ: + 7 495 98815 17</p> <p>service@binder-world.com www.binder-world.com</p> 



Figure 1: Position of labels on the chamber

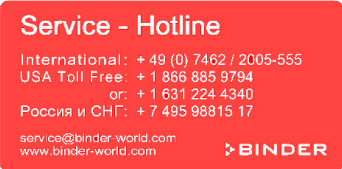

Keep safety labels complete and legible.

Replace safety labels that are no longer legible. Contact BINDER Service for these replacements.

1.4 Type plate

Position of type plate: left chamber side (seen from front), at the bottom right-hand.





Nominal temp.	200 °C 392 °F	1,20 kW / 5,3 A 230 V / 50/60 Hz		Explosion proof inner chamber EX classification acc. to 2014/34/EU II -/3G c IIB T3-T1 Gc X Max. temp. of inner surface +320 °C Temp. class depending on setting of temp. safety device
IP protection	54	Safety device DIN 12880		
Class	2.0	1 N ~		
Art. No.	9030-0039			
Project No.		Max. operating pressure 125 +/- 25 mbar		
Built	2015	Constant climate chamber		
		BINDER GmbH Im Mittleren Ösch 5 78532 Tuttlingen / Germany www.binder-world.com	VDL 53 E2.1	Serial No. 00-00000 Made in Germany

Figure 2: Type plate (example of VDL 53 regular chamber)

Indications of the type plate (example)		Information
BINDER		Manufacturer: BINDER GmbH
VDL 53		Model designation
Vacuum Drying Oven		Device name: Vacuum drying oven
Serial No.	00-00000	Serial No. of the chamber
Built	2015	Year of construction
Nominal temperature	200 °C 392 °F	Nominal temperature
IP protection	54	Type of IP protection acc. to standard EN 60529
Temp. safety device	DIN 12880	Temperature safety device acc. to standard DIN 12880:2007
Class	2.0	Class of temperature safety device
Art. No.	9030-0039	Art. No. of the chamber
Project No.	---	Optional: Special application acc. to project no.

--	--	--

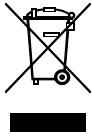
Indications of the type plate (example)	Information
1,20 kW	Nominal power
5,3 A	Nominal current
230 V / 50Hz	Nominal voltage \pm 10% at the indicated power frequency
230 V / 60 Hz	
1 N ~	Current type
Explosion proof inner chamber	Explosion proof inner chamber
Ex classification acc. to 2014/34/EU	Ex classification according to ATEX Directive 2014/34/EU
II -/3G c IIB T3-T1 Gc X	Ex classification of the inner chamber:  II -/3G c IIB T3-T1 Gc X
Max. temp. of inner surface 320 °C	Maximum temperature of the inner surfaces: 320 °C / 608°F
Temp. class depending on setting of temp. safety device	Temperature class acc. to IEC 60079-14 for the entire chamber: T1, T2 or T3 depending on the setting of the temperature safety device
Max. operating pressure 125 +/- 25 mbar	Max. operating pressure (heating release): 125 +/- 25 mbar

Symbol	Information
	CE conformity marking
	Ex classification acc. to ATEX Directive 2014/34/EU, referring to the inner chamber
	TÜV mark of conformity (Mark P)
	Electrical and electronic equipment manufactured / placed on the market in the EC after 13 August 2005 and to be disposed of in a separate collection according to directive 2002/96/EC on waste electrical and electronic equipment (WEEE).
	The equipment is certified according to Customs Union Technical Regulation (CU TR) for Russia, Belarus and Kazakhstan

1.5 General safety instructions on installing and operating the vacuum drying oven

With regard to operating the vacuum drying oven VDL and to the installation location, please observe the DGUV guidelines 213-850 on safe working in laboratories (formerly BGI/GUV-I 850-0, BGR/GUV-R 120 or ZH 1/119, issued by the employers' liability insurance association) (for Germany).

BINDER GmbH is only responsible for the safety features of the chamber provided skilled electricians or qualified personnel authorized by BINDER perform all maintenance and repair, and if components relating to chamber safety are replaced in the event of failure with original spare parts.



To operate the chamber, use only original BINDER accessories or accessories from third-party suppliers authorized by BINDER. The user is responsible for any risk caused by using unauthorized accessories.

1.5.1 Safety instructions on installation and ambient conditions

Familiarize yourself with the local conditions, particularly allocation to a defined potentially explosive area (zones) and the relevant technical safety requirements. During installation, commissioning and operation of the vacuum drying oven and the connected vacuum pump or in-house vacuum supply, always follow the requirements defined by the installation site.

	CAUTION
	<p>Danger of overheating. Damage to the chamber.</p> <ul style="list-style-type: none"> ⊘ Do NOT install the oven in unventilated recesses. ➤ Ensure sufficient ventilation for dispersal of the heat.

Do not install and operate the vacuum drying oven VDL in hazardous locations.

	 DANGER
	<p>Explosion hazard. Danger of death.</p> <ul style="list-style-type: none"> ⊘ Do NOT operate the chamber in potentially explosive areas. ➤ KEEP explosive dust or air-solvent mixtures AWAY from the chamber.

The vacuum drying ovens were constructed in accordance with the applicable VDE regulations and were routinely tested in accordance with VDE 0411-1 (IEC 61010-1). The production underlies an internal monitoring according to ATEX Directive 2014/34/EU appendix VIII.

For the user there is no risk of temporary overvoltages in the sense of EN 61010-1:2010.

Even when the equipment is used properly, there exists a residual risk of explosion that cannot be excluded, particularly in relation to the environment of the chamber. To minimize this risk, strictly observe the legal regulations about how to select an appropriate location.

	 DANGER
	<p>Explosion hazard. Danger of death.</p> <ul style="list-style-type: none"> ➤ Strictly observe the legal regulations about how to select an appropriate location.

The walkable operating surface in the front area of the chamber must be conductive. This operating surface must be connected to the existing grounding concept of the vacuum drying oven. Cyclic measurements are required.

The operator must ensure adequate ventilation of the loading area in front of the chamber before starting up the chamber. The loading and the removal of the charging material takes place under technical ventilation (suction) in the security area in front of the chamber.

1.5.2 Safety instructions on vacuum supply





Within the European Union, units that will be operated in potentially explosive areas have to meet the requirements of ATEX Directive 2014/34/EU.

If combustible solvent is introduced into the drying chamber, the vacuum pump must be constructed in a suitable explosion-proof manner.





	<p>Observe the safety instructions of the pump manufacturer.</p>
---	--

The mixtures extracted from the inner chamber must be carried away making sure that there is no danger by ignition of these atmospheres. Otherwise, use flame arresters (flame flash-through barrier). For installing a flame arrester, please contact the BINDER INDIVIDUAL team.

In case of an explosion, the flame can be suctioned into an in-house vacuum system thereby resulting in further explosions.

	<table border="1"> <tr> <td data-bbox="853 801 917 869">  </td> <td data-bbox="933 801 1468 869"> <p>DANGER</p> </td> </tr> <tr> <td colspan="2" data-bbox="391 880 1468 1039"> <p>Danger due to flame flash-through with in-house vacuum system.</p> <p>Danger of death.</p> <p>We recommend installing a flame arrester (flame flash-through barrier) according to EN ISO 16852:2010 between the VDL vacuum drying oven and the in-house vacuum system.</p> </td> </tr> </table>		<p>DANGER</p>	<p>Danger due to flame flash-through with in-house vacuum system.</p> <p>Danger of death.</p> <p>We recommend installing a flame arrester (flame flash-through barrier) according to EN ISO 16852:2010 between the VDL vacuum drying oven and the in-house vacuum system.</p>	
	<p>DANGER</p>				
<p>Danger due to flame flash-through with in-house vacuum system.</p> <p>Danger of death.</p> <p>We recommend installing a flame arrester (flame flash-through barrier) according to EN ISO 16852:2010 between the VDL vacuum drying oven and the in-house vacuum system.</p>					

Sparking in the pump motor or the switching elements, electrostatic discharges, as well as hot pump parts can ignite solvent vapors in the event of an error. To minimize this risk, use an ATEX Directive 2014/34/EU compliant vacuum pump suitable for suction from Zone 0 or 1 and, if appropriate, from the zone of its installation site.



	<table border="1"> <tr> <td data-bbox="853 1209 917 1276">  </td> <td data-bbox="933 1209 1468 1276"> <p>DANGER</p> </td> </tr> <tr> <td colspan="2" data-bbox="391 1288 1468 1971"> <p>Ignition of emerging solvent vapors due to sparking in the pump motor or the switching elements, electrostatic discharges, hot pump parts.</p> <p>Explosion hazard.</p> <p>Danger of death.</p> <ul style="list-style-type: none"> ➤ Use only suitable, explosion-proof pumps ➤ Operate the pump in a stationary position and secure it so it is immobile. ➤ Install a fixed and conductive suction line to the vacuum connection (13). ➤ Install a fixed and conductive exhaust pipe in case it may conduct ignitable solvent concentrations. This should be avoided by sufficient solvent condensation e.g., in an exhaust waste vapor condenser ➤ When using ATEX Directive 2014/34/EU non-compliant pumps: Provide a current-dependent, delayed protective device for the pump (for the triggering time of this protective device, see the manufacturer's specifications). The protective and monitoring device must not be able to turn on independently again or be released. ➤ When using ATEX Directive 2014/34/EU non-compliant pumps: Install the switch gear box outside the hazardous area or provide it with explosion protection. ➤ Assure equipotential bonding between the pump housing and the housing of the VDL vacuum drying oven by the connected equipment grounding conductors of both units. </td> </tr> </table>		<p>DANGER</p>	<p>Ignition of emerging solvent vapors due to sparking in the pump motor or the switching elements, electrostatic discharges, hot pump parts.</p> <p>Explosion hazard.</p> <p>Danger of death.</p> <ul style="list-style-type: none"> ➤ Use only suitable, explosion-proof pumps ➤ Operate the pump in a stationary position and secure it so it is immobile. ➤ Install a fixed and conductive suction line to the vacuum connection (13). ➤ Install a fixed and conductive exhaust pipe in case it may conduct ignitable solvent concentrations. This should be avoided by sufficient solvent condensation e.g., in an exhaust waste vapor condenser ➤ When using ATEX Directive 2014/34/EU non-compliant pumps: Provide a current-dependent, delayed protective device for the pump (for the triggering time of this protective device, see the manufacturer's specifications). The protective and monitoring device must not be able to turn on independently again or be released. ➤ When using ATEX Directive 2014/34/EU non-compliant pumps: Install the switch gear box outside the hazardous area or provide it with explosion protection. ➤ Assure equipotential bonding between the pump housing and the housing of the VDL vacuum drying oven by the connected equipment grounding conductors of both units. 	
	<p>DANGER</p>				
<p>Ignition of emerging solvent vapors due to sparking in the pump motor or the switching elements, electrostatic discharges, hot pump parts.</p> <p>Explosion hazard.</p> <p>Danger of death.</p> <ul style="list-style-type: none"> ➤ Use only suitable, explosion-proof pumps ➤ Operate the pump in a stationary position and secure it so it is immobile. ➤ Install a fixed and conductive suction line to the vacuum connection (13). ➤ Install a fixed and conductive exhaust pipe in case it may conduct ignitable solvent concentrations. This should be avoided by sufficient solvent condensation e.g., in an exhaust waste vapor condenser ➤ When using ATEX Directive 2014/34/EU non-compliant pumps: Provide a current-dependent, delayed protective device for the pump (for the triggering time of this protective device, see the manufacturer's specifications). The protective and monitoring device must not be able to turn on independently again or be released. ➤ When using ATEX Directive 2014/34/EU non-compliant pumps: Install the switch gear box outside the hazardous area or provide it with explosion protection. ➤ Assure equipotential bonding between the pump housing and the housing of the VDL vacuum drying oven by the connected equipment grounding conductors of both units. 					

	The ATEX Directive 2014/34/EU compliant pumps offered by BINDER provide an integral protective device.
---	--

	The ATEX Directive 2014/34/EU compliant pumps offered by BINDER provide an integral explosion proof switch.
---	---

	Confirm that the vacuum source is designed for a gas inlet temperature corresponding to the used drying temperature, or take appropriate measures to cool down the extracted vapor before it enters the vacuum source.
---	--



The ATEX Directive 2014/34/EU compliant vacuum pumps offered by BINDER are designed for a gas inlet temperature of 40 °C / 104°F max. Do NOT exceed this temperature. If the gas inlet temperature is too high and then becomes even warmer by compression in the pump, the resulting temperature (of the gas-solvent mixture inside the pump) could exceed the solvent's temperature class and ignition temperature.

	 DANGER
	<p>Exceeding the gas inlet temperature.</p> <p>Exceeding the ignition temperature of the solvent.</p> <p>Risk of ignition and explosion.</p> <p>Damage to the vacuum pump.</p> <p>Danger of death.</p> <ul style="list-style-type: none"> ⊘ Do NOT exceed a set-point temperature of 40 °C / 104 °F. ➤ With set-point temperature > 40 °C / 104 °F, take appropriate measures to cool down the extracted vapor before it enters into to the vacuum pump.



1.5.3 Safety instructions on the charging material

The temperature class of the inner chamber according to IEC 60079-14 can be T1, T2, or T3. Only introduce substances with an ignition temperature that is higher than 135 °C / 275°F. You can use a solvent which would form an explosive mixture with air under normal conditions.

This chamber is not suitable to dry substances with an ignition temperature below 135 °C / 275°F. Substances falling under ignition group IIC are not permitted (e.g. carbon disulfide, hydrogen).

	 DANGER
	<p>Inappropriate charging material.</p> <p>Explosion hazard.</p> <p>Danger of death.</p> <ul style="list-style-type: none"> ⊘ Do NOT introduce any substance with an ignition temperature below 135 °C / 275 °F into the oven. ⊘ Do NOT introduce hazardous dusts or fibrous materials, which tend towards exothermal decomposition into the oven. ⊘ Do NOT introduce materials that come under the explosive substance law into the oven.

If the ignition temperature of a solvent contained in the drying material is exceeded during the drying process, there is an immediate risk of fire and explosion.

	 DANGER
	<p>Formation of explosive solvent-air mixtures.</p> <p>Fire and explosion hazard.</p> <p>Danger of death.</p> <p>∅ The ignition temperature of the contained solvents must NEVER be reached. For safety reasons, you must provide a safety gap.</p>

If the following precautions are not followed, the vapors resulting from heating of the solvent can ignite on the hot walls of the inner chamber.

	<p>Required measures:</p> <ul style="list-style-type: none"> • The maximum drying temperature is a result of the lowest ignition temperature of the introduced solvent or solvent mixture. Take the ignition temperature from the safety specifications of the solvent. Determine the maximum drying temperature according to the information panel "Temperature setting" (chap. 2.5) on the chamber front. Do NOT exceed this temperature when presetting the set point on the RD3 temperature controller. • Before starting the drying process, set the temperature safety device to the maximum allowed drying temperature according to the information panel "Temperature setting" (chap. 2.5). This will ensure that even in the event of error or an incorrect increase of the temperature set point on the RD3 controller the maximum permissible drying temperature is not exceeded. It is NOT sufficient to directly adjust the maximum temperature of the temperature safety device to the maximum temperature of the solvent's temperature class. • During the drying process, use only those solvents for which the temperature setting has been performed. • In the case of solvent mixtures, use the ignition temperature of the material with the lowest ignition temperature. For the correct ignition temperature, refer to the safety specifications of the solvent. • Let the oven cool down to ambient temperature before you start a new drying process with a modified ignition temperature. A downtime must be maintained.
---	--



Familiarize yourself with the physical and chemical properties of the charging material, as well as the contained moisture constituent and its behavior with the addition of heat energy and changes in pressure. No dangerous chemical reactions must occur during the drying process.

Familiarize yourself with any potential health risks caused by the charging material, the contained moisture constituent or by reaction products that may arise during the drying process. Take adequate measures to exclude such risks prior to putting the VDL vacuum drying oven into operation.

1.5.4 Safety instructions on operating the vacuum drying oven

	<p>Note the following points before starting up the oven:</p> <ul style="list-style-type: none"> • When loading the chamber and possibly at the moment of removal, also in the context of intended use, an explosive mixture may form in the working space. Define a safety area of at least 1m from the chamber front and ensure ventilation / venting. • The accessible ground surface in front of the oven must be electrically conductive. This operating area must be connected to the existing grounding concept of the vacuum drying oven. Provide cyclic measurements. • The operator must ensure an appropriate ventilation of the loading area in front of the oven front prior to commissioning of the oven. • Ensure that at no time any solvent vapors could enter in the area of the electrical installation room and the operating panel. • Provide ventilation in the area of the vacuum pump stand, particularly in the areas of the glass flask (when emptying it) and the exhaust air of the vacuum pump. • The accessible area in front of the equipment must be designed conductive. Provided cyclic measurements. • The personal protective equipment (PPE) of the operating personnel must be implemented ESD protected.
---	--



	 DANGER
	<p>Electrical hazard. Danger of death.</p> <p>∅ The oven must NOT become wet during operation or maintenance.</p>

	 CAUTION
	<p>The inner chamber will become hot during operation. Danger of burning.</p> <p>∅ Do NOT touch the inner surfaces or the charging material during operation.</p>



When operating the VDL vacuum drying oven with inert gas, correctly follow the technical ventilation measures, as described in the DGUV guidelines 213-850 on safe working in laboratories (formerly BGI/GUV-I 850-0, BGR/GUV-R 120 or ZH 1/119, issued by the employers' liability insurance association) (for Germany).

	<p>Do not start up the chamber without technical ventilation.</p>
---	---



During operation with inert gas, the chamber is supplied with an oxygen displacing gas (e.g. N₂). Inert gases in high concentrations are hazardous to health. They are colorless and almost odorless and therefore practically imperceptible. Inhalation of inert gases can cause drowsiness up to respiratory arrest. When the O₂ content of the air decreases below 18%, there is risk of death from lack of oxygen. Any gas that might escape has to be led out via good room ventilation or a suitable exhaust system.

	 WARNING
	<p>High concentration of inert gas. Risk of death by suffocation.</p> <ul style="list-style-type: none"> ⊘ Do NOT set up chambers in non-ventilated recesses. ➤ Ensure technical ventilation measures. ➤ Respect the relevant regulations for handling these gases. ➤ When decommissioning the vacuum drying oven, shut off the inert gas supply: Close valve (6).

If solvent-containing air penetrates the electrical area of the oven, explosions may result.

	 DANGER
	<p>Solvent-containing air penetrating the electrical area of the oven. Explosion hazard.</p> <ul style="list-style-type: none"> ⊘ Do NOT take the air, which will be used to supply the chamber with compressed air, from a potentially explosive atmosphere.

	<p>Avoid the solvent accumulation in the vacuum module (option) as this would cause the vacuum module to become an explosive area (Zone 0 or 1 or 2). The VDL vacuum drying oven located on top of the module is not explosion-proof constructed in regards to its surroundings.</p>
---	--

	 DANGER
	<p>Operation with material containing solvent that may be able to form an explosive mixture with air. Explosion hazard.</p> <ul style="list-style-type: none"> ➤ Follow the measures required for operation with solvent-containing materials that can form an explosive mixture with air.



Measures required for operation with solvent-containing materials that can form an explosive mixture with air:

- Only trained personnel with key-authorization can work on the VDL vacuum drying oven
- Sweep the area for electrical equipment with compressed air or inert gas for at least 15 minutes. Sweeping must take place during the entire operating cycle; otherwise the vacuum drying oven will shut off at all poles.
- Only after at this sweeping time, use the key switch to put the chamber in operation.
- Do not use the week program timer when using explosive substances. Make sure in this case that the week program timer has been deactivated in the User Level (chap. 10).
- Determine the maximum drying temperature in relation to the ignition temperature of the solvent according to the information panel "Temperature setting" (chap. 2.5). In the case of solvent mixtures, use the ignition temperature of the solvent with the lowest ignition temperature. For the ignition temperature, refer to the safety specifications of the solvent.
- Do NOT exceed this temperature when presetting the set point on the RD3 temperature controller.
- Before starting the drying process, set the temperature safety device to the determined maximum allowed drying temperature according to the information panel "Temperature setting" (chap. 2.5). It is NOT sufficient to directly adjust the maximum temperature of the temperature safety device to the maximum temperature of the solvent's temperature class.
- Introduce the drying material and turn on the vacuum pump.
- Start the drying process. The heating unit is only released when a vacuum of 125 ± 25 mbar / 3.69 ± 0.74 inHg) or below is reached.
- The duration of the drying process can be determined by means of the analogue pressure display on the oven. When the pressure drops to pump pressure, the drying process is finished.
- After termination of the drying process, ventilate the vacuum drying oven using the aeration valve for ambient air (5) or inert gas (6), remove the charging material, and turn the key switch to position 0 (OFF) and remove the key to prevent unauthorized operation of the oven.
- Sweep the area for electrical equipment at least 15 minutes with compressed air or inert gas.
- Let the oven cool down to ambient temperature before you start a new drying process with a modified ignition temperature.

1.6 Intended use

The VDL vacuum drying ovens are suitable for drying and heat treatment of solid or pulverized charging material, as well as bulk material, using the supply of heat under vacuum.

During this process, the contained solvent may be able to form an explosive mixture with air under normal conditions. Generation of an explosive atmosphere and its ignition are prevented in the VDL vacuum drying ovens by various safety measures. The drying temperature with standard safety factor must lie below the ignition temperature and below the sublimation point of the charging material.

The VDL vacuum drying oven is explicitly approved for drying of materials with unlimited amounts of organic solvents. The VDL is equipped with an explosion-proof inner chamber.

The temperature class of the inner chamber according to IEC 60079-14 can be T1, T2, or T3. It depends on the maximum operation temperature inside the oven. Depending on the ignition temperature of the flammable substance, this temperature can be adjustably set on the temperature safety device according to the "Temperature setting" information panel (chap. 2.5).

Insert only substances with an ignition temperature that is higher than 135 °C / 275 °F. The chamber is not suitable to dry substances with an ignition temperature below 135 °C / 275 °F. Substances falling under ignition group IIC are not permitted (e.g. carbon disulfide, hydrogen).

The VDL vacuum drying ovens are NOT suitable for the heat treatment of hazardous dusts or fibrous materials, which tend towards exothermal decomposition, or for materials that come under the legal definition of explosives. Such substances must not be introduced into the oven. Dangerous chemical reactions must not occur during the drying process.

VDL vacuum drying ovens are not suitable for use in conjunction with explosive dust atmospheres or hybrid mixtures.

Do not use the week program timer when using explosive substances.

Other applications are not approved.

The chambers are not classified as medical devices as defined by the Medical Device Directive 93/42/EEC.



Following the instructions in this operating manual and conducting regular maintenance work (chap. 16) are part of the intended use.



The charging material shall not contain any corrosive ingredients that may damage the machine components made of stainless steel and aluminum. Such ingredients include in particular acids and halides. Any corrosive damage caused by such ingredients is excluded from liability by BINDER GmbH.

1.6.1 Operation log

For safety reasons, keep an operation log.

The following contents must be entered and recorded:

- Type of solvent
- Ignition temperature
- Set temperature
- Set safety device
- Date
- Signature

Use the following page as a specimen or compile it in a suitable form.

2. Description of the equipment

The VDL vacuum drying oven has been inspected by the TÜV Product Service GmbH in accordance with all safety-relevant guidelines and bears the TÜV-Mark P mark. Consequently, it is also expressly approved for drying materials with unlimited quantities of organic solvents.

The regular model is equipped with an explosion proof inner chamber. The Ex classification of inner chamber according to ATEX Directive 2014/34/EU is  II -/3G c IIB T3-T1 Gc X. The description of explosion protection on the type plate determines the classification.

Maximum temperature of the inner surfaces: 320 °C / 608°F.

The temperature class of the inner chamber acc. to IEC 60079-14: depends on the setting of the temperature safety device and can be **T1**, **T2** or **T3**. The temperature class of the entire chamber equals the temperature class of the inner chamber.

All functions of the multifunctional program control can be set simply and conveniently via the easy to understand function keypad of the RD3 temperature program controller. This controller is equipped with touch function keys and a digital display and permits exact temperature setting and programming temperature cycles. The VDL provides almost unlimited possibilities of adapting to individual customer requirements based upon extensive programming options and on the real time clock of the controller.

The inner chamber is made of especially corrosion resistant stainless steel V4A (German material no. 1.4404 2B, US equivalent AISI 316L) micro-polished. The rack holder and all of the chamber's vacuum connections and valves are made of especially corrosion resistant stainless steel V4A (German material no. 1.4571, US equivalent AISI 316Ti). The housing is RAL 7035 powder-coated. All corners and edges are also completely coated. When operating the chamber at temperatures above 150 °C / 302°F, the impact of the oxygen in the air may cause discoloration of the metallic surfaces (yellowish-brown or blue) by natural oxidation processes. These colorations are harmless and will in no way impair the function or quality of the chamber.

The vacuum expansion racks allow for low-loss heat transfer to the material. The strong tension causes the racks to fit tightly against the interior wall and their large-surface contact area ensures rapid and effective heat transfer.

The vacuum drying ovens in the APT.line™ are jacket-heated. The APT.line™ preheating chamber technique ensures a completely homogeneous jacket temperature, ensuring uniform heat transfer into the inner chamber. The low-loss heat transfer to the material uses the patented aluminum vacuum expansion racks (or optionally available in stainless steel V4A, 1.4571). The elastic-mounted safety glass window reliably compensates any overpressure or explosions that may occur. The additional polycarbonate panel ensures proven and effective splinter protection in the event of an implosion.

All VDL chambers provide an inert gas connection, a compressed air connection for sweeping the area for electrical equipment, and a measuring connection serving to connect a measuring access port.

The VDL vacuum drying oven is equipped with a serial interface RS 422 for computer communication, e.g. via the communication software APT-COM™ 3 DataControlSystem (option, chap.15.6). For further options, see chap. 19.3.

All installable items, such as racks and rack holders, can be easily removed. The completely smooth inner chamber with its rounded corners and internally welded seams is easy to clean.

The minimum working temperature of the VDL vacuum drying oven is approx. 15 °C / 27 °F above room temperature. The maximum temperature is 200 °C / 392°F.

Vacuum pumps with a suction capacity of 1 m³/h to 30 m³/h are suitable for the VDL vacuum drying oven. The permissible end vacuum is 10⁻² mbar / 0.0003 inHg.

2.1 Safety equipment

- **Pressure control device**

The VDL vacuum drying oven is equipped with a pressure control device with atmospheric pressure compensation and has a set switch point of $125 \pm 25 \text{ mbar}$ / $3.69 \pm 0.74 \text{ inHg}$). In the event of malfunction, some procedures would become an ignition source. Due to monitoring by the pressure control device such actions will only initiate if the pressure in the drying chamber is not higher than $125 \pm 25 \text{ mbar}$ / $3.69 \pm 0.74 \text{ inHg}$.



The heating is released when a vacuum of $125 \pm 25 \text{ mbar}$ / $3.69 \pm 0.74 \text{ inHg}$ or below is obtained. It will activate only then.

- **Safety device class 2**

This safety device protects the VDL vacuum drying oven, its environment and the charging material against impermissible excess temperatures. When correctly set to the maximum permissible drying temperature it prevents exceeding the maximum drying temperature in case of a fault (chap. 12).

- **Sweeping the area for electrical equipment and the preheating chamber with compressed air**

The area for electrical equipment and the preheating chamber are protected against penetration of explosive atmosphere by a technical ventilation system (1.8 bar overpressure). This is monitored by a pressure sensor with a fixed switching threshold. Pressure loss results in turning off the entire oven. This reliably prevents explosive atmosphere to reach electrical or electronic parts of the VDL safety vacuum drying oven (protection against solvent-containing ambient air).

- **Flame protection gasket**

In case of an explosion, the flame protection gasket prevents any flames from emerging directly through the door gap..

- **Spring-mounted safety glass panel and splinter protection**

The VDL vacuum drying oven is equipped with a large-surface area safety valve.

The inspection window, consisting of ESG glass (toughened safety glass), is spring-mounted and serves as a safety valve in the event of explosion. The additional plastic panel provides splinter-protection.

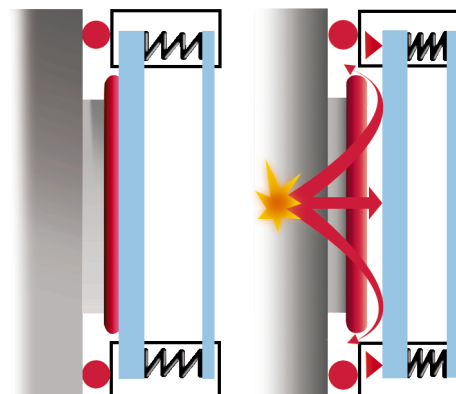

Figure 3: Safety glass panel

2.2 Overview of the oven

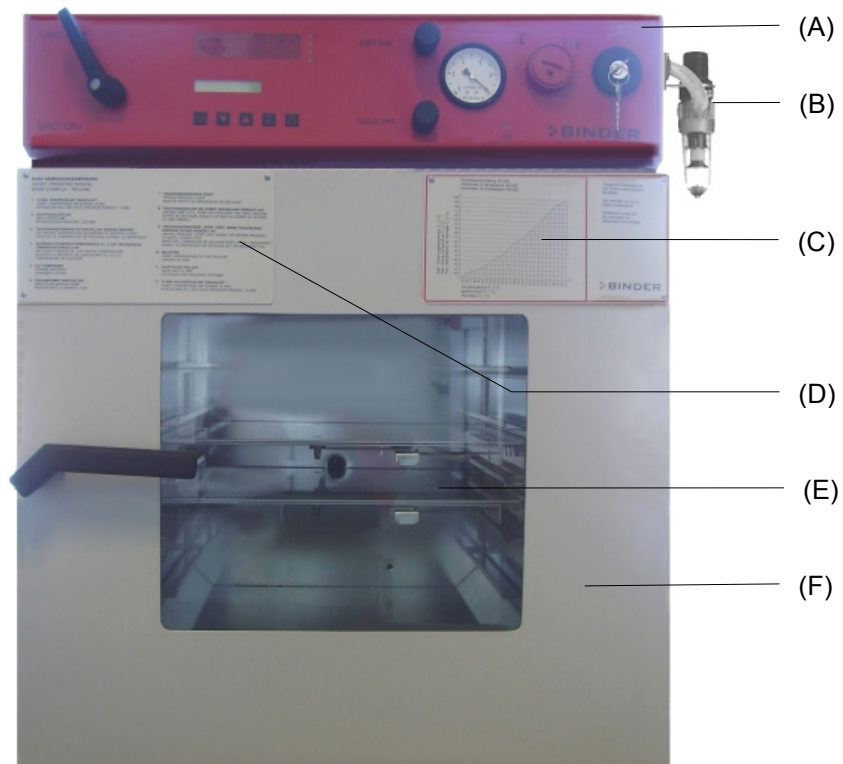

Figure 4: VDL 53

- (A) Area for electrical equipment swept with compressed air, and control panel
- (B) Compressed air connection
- (C) Information panel "Temperature setting"
- (D) Information panel short description
- (E) Spring-mounted safety glass window
- (F) Chamber door

2.3 VDL control panel

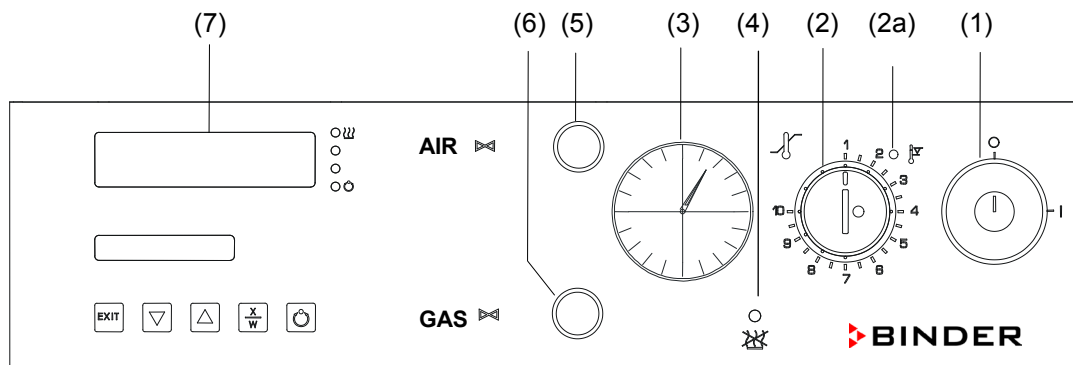

Figure 5: VDL 23 control panel

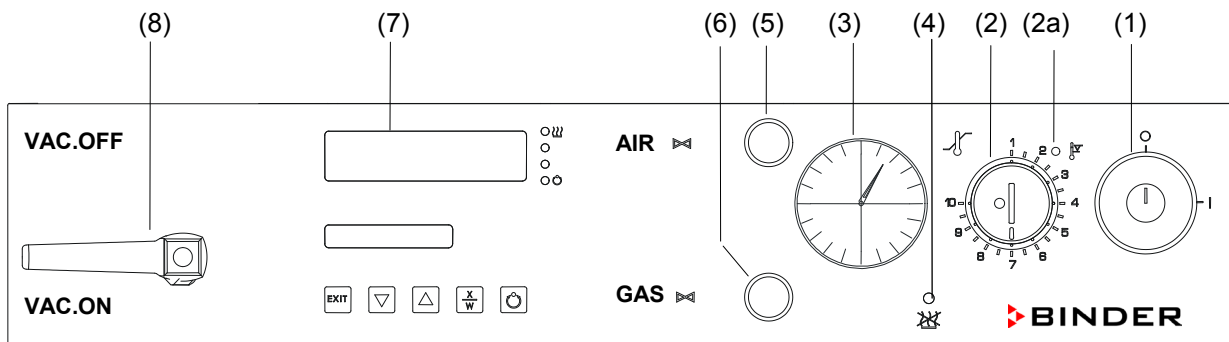
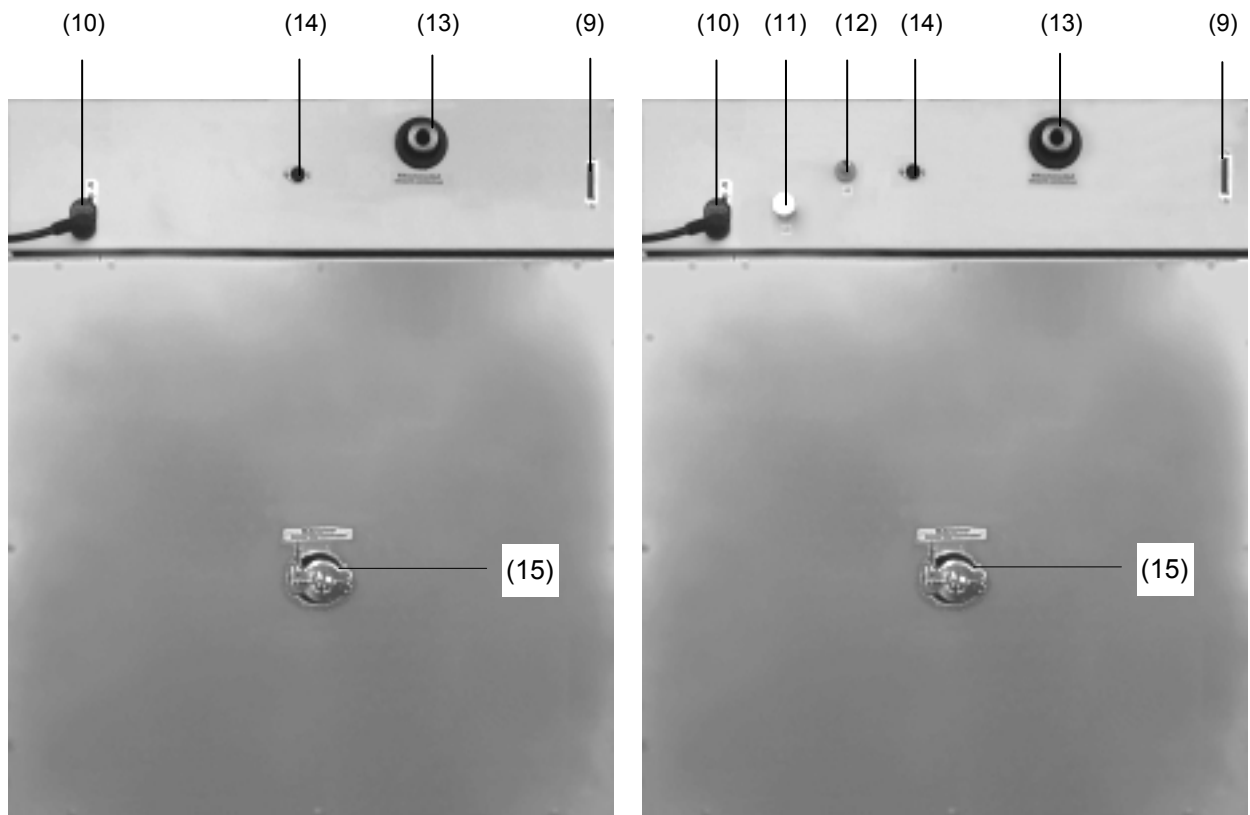

Figure 6: VDL 53/115 control panel

- (1) Key switch (main power switch)
- (2) Temperature safety device class 2
- (2a) Red alarm lamp of the safety device class 2
- (3) Manometer (pressure reading)
- (4) Yellow pilot light: No heating release
- (5) Aeration valve (ambient air)
- (6) Fine dosing valve (inert gas)
- (7) Program controller RD3
- (8) Vacuum shut-off valve

2.4 Connections at the rear of the chamber



VDL 23

VDL 53 / VDL 115

Figure 7: Rear of VDL

- (8) Vacuum shut-off valve
- (9) RS 422 serial interface for computer communication
- (10) Power connection line
- (11) Inert gas connection, adapter with hose olive
Ø 8 mm / 0.31 in
- (12) Fresh air connection (tube 8x1 mm)
- (13) Vacuum connection with small flange DN16
- (14) DIN socket "Object-Pt100" (option) to connect a Pt 100 sensor (with option "object temperature display")
- (15) Measuring connection with small flange DN16

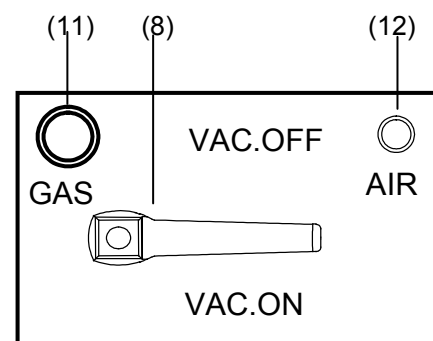

Figure 8: Connections left side VDL 23

2.5 “Temperature setting” information panel (ignition temperature vs. drying temperature)

This information panel is mounted to the door of the VDL vacuum drying oven and shows the maximum permissible drying temperature depending on the ignition temperature of the solvent.

The reading graph reflects the fact that the inner chamber walls will become warmer than the expansion racks, especially during the heating-up phase, and will thereby exceed the set-point temperature.

Therefore, it is important to observe the indicated safety margin, i.e. the difference between ignition temperature and drying temperature.

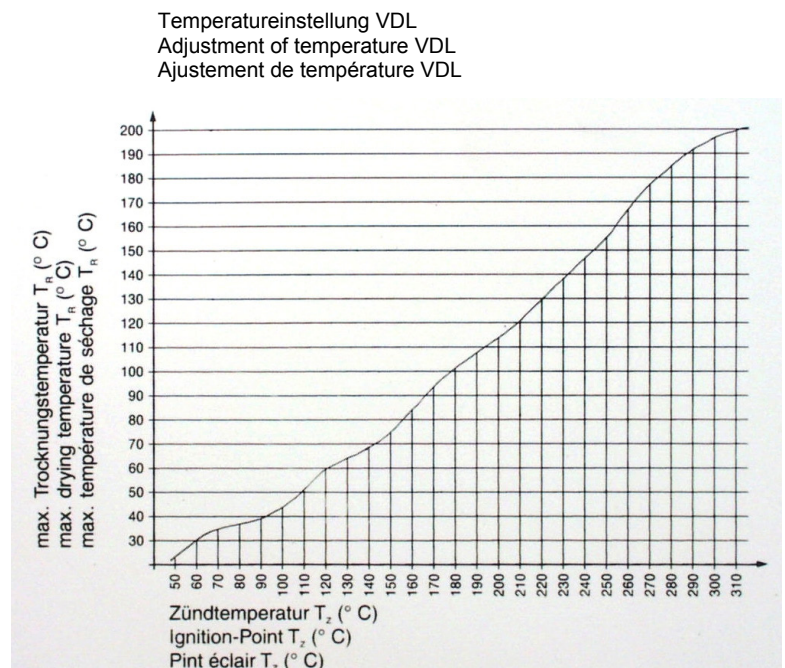

Figure 9: Temperature setting information panel



You must observe the indicated safety margin between ignition temperature and drying temperature.

According to IEC 60079-14, you must introduce only substances with an ignition temperature which is higher than 135 °C / 275°F. **This chamber is NOT suitable to dry substances with an ignition temperature below 135 °C / 275°F.**

If the ignition temperature of a solvent contained in the drying material is exceeded during the drying process, there is an immediate risk of fire and explosion.



DANGER

Exceeding the ignition temperature of a solvent.

Risk of fire and explosion.

Danger of death.

⊘ The ignition temperature of a contained solvent must NEVER be reached. For safety reasons, always ensure that there is a safety margin.



Required measures:

- Determine the maximum drying temperature in relation to the ignition temperature of the solvent in accordance with the “Temperature setting” information panel (chap. 2.5). Do NOT exceed this temperature when presetting the set-point temperature at the temperature controller RD3.
- Before starting the drying process, set the temperature safety device to the allowed maximum drying temperature according to the information panel “temperature setting” chap. 2.5), so that even in the event of error or incorrect increase of the temperature set-point on the RD3 controller the maximum permissible drying temperature is not exceeded. It is NOT sufficient to directly adjust the maximum temperature of the temperature safety device to the maximum temperature of the solvent’s temperature class.
- (continued)



Required measures (continuation):

- During the drying process, use only those solvents for which the temperature setting has been performed.
- In the case of solvent mixtures, use the ignition temperature of the material with the lowest ignition temperature. For the ignition temperature, refer to the safety specifications of the solvent.
- Let the oven cool down to ambient temperature before you start a new drying process with a modified ignition temperature.

2.6 Overview of the zone classification of the ovens

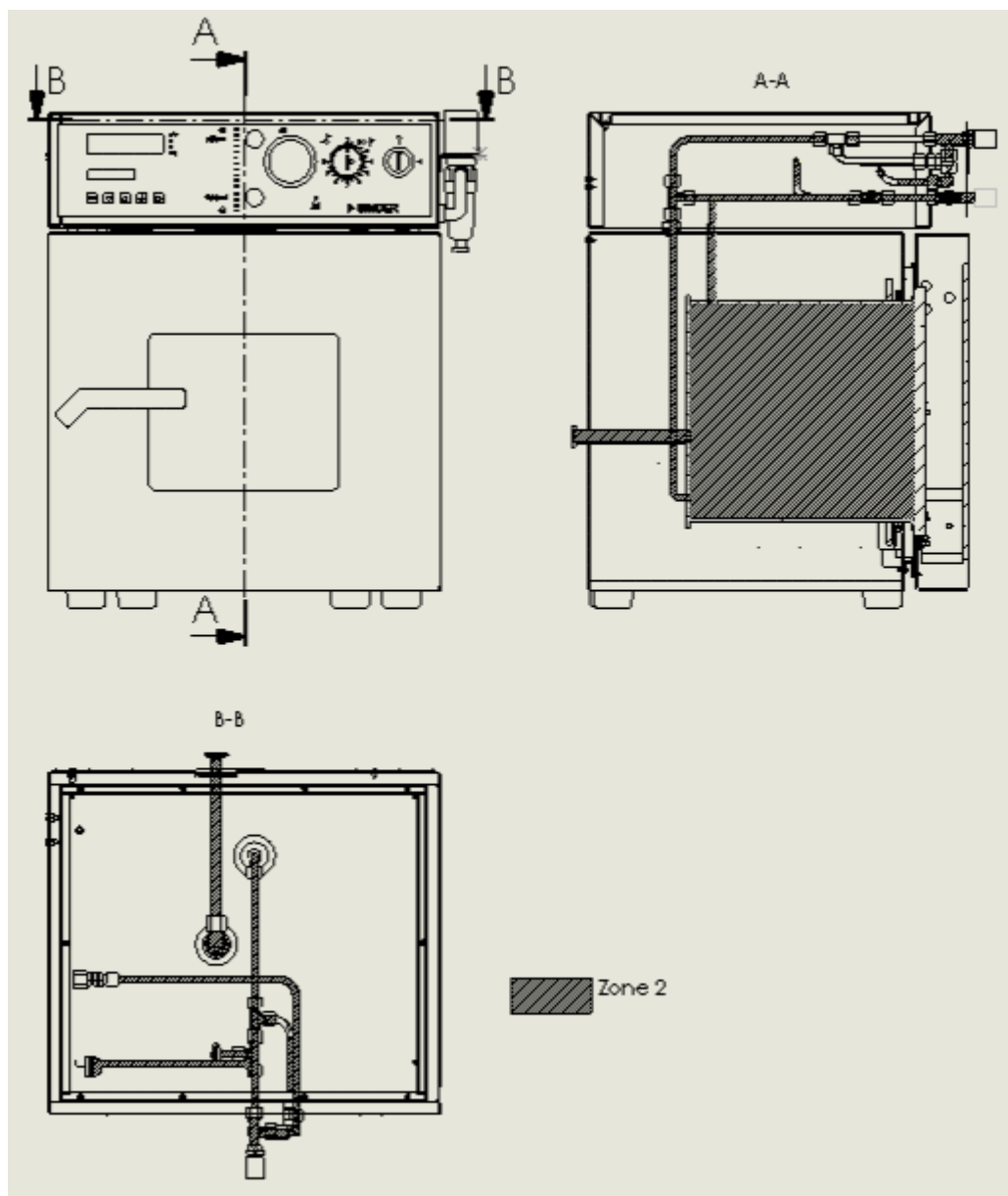

Figure 10: Zone classification VDL 23

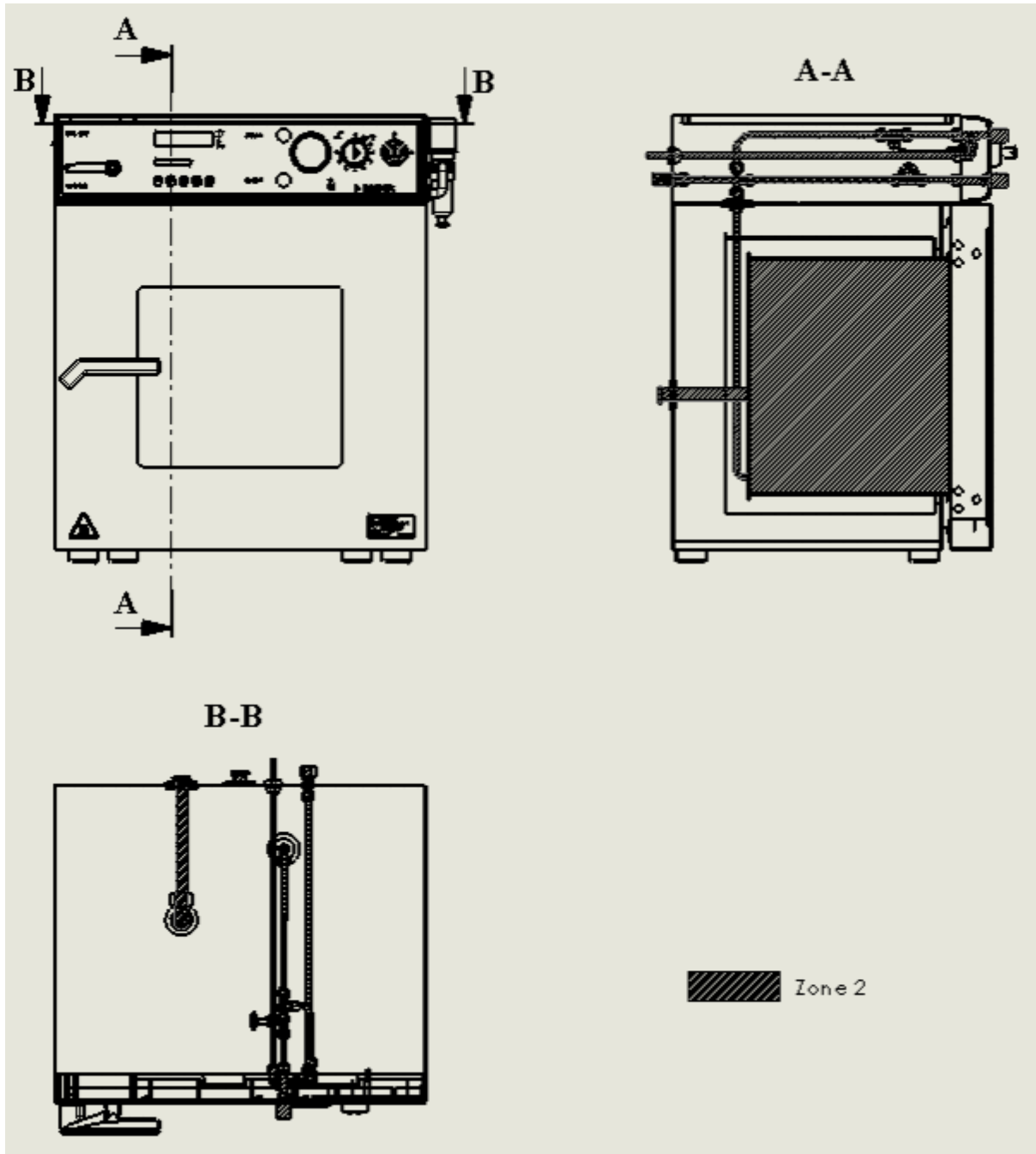

Figure 11: Zone classification VDL 53 and 115





3. Completeness of delivery, transportation, storage, and installation

3.1 Unpacking, and checking equipment and completeness of delivery

After unpacking, please check the chamber and its optional accessories, if any, based on the delivery note for completeness and for transportation damage. Inform the carrier immediately if transportation damage has occurred.

The final tests of the manufacturer may have caused traces of the racks on the inner surfaces. This has no impact on the function and performance of the chamber.

Please remove any transportation protection devices and adhesives in/on the chamber and on the doors and take out the operating manuals and accessory equipment.

  	 CAUTION
<p>Sliding or tilting of the chamber. Damage to the chamber. Risk of injury by lifting heavy loads.</p> <ul style="list-style-type: none"> ⊘ Do NOT lift or transport the chamber using the door, the handle, or the lower housing. ➤ Lift chambers size 23 and 53 from the pallet at the four lower corners with the aid of 4 people. ➤ Lift chambers size 115 from the pallet with the aid of 6 people. 	

If you need to return the chamber, please use the original packing and observe the guidelines for safe lifting and transportation (chap. 3.2).

For disposal of the transport packing, see chap. 17.1.

If you ordered the option “vacuum module with chemical membrane pump”, the pump will be delivered in a separate box and must be fitted into the module and connected at the place of installation (see chap. 15.3).





Note on second-hand chambers (Ex-Demo-Units):

Second-hand chambers are chambers that have been used for a short time for tests or exhibitions. They are thoroughly tested before resale. BINDER ensures that the chamber is technically sound and will work flawlessly.

Second-hand chambers are marked with a sticker on the chamber door. Please remove the sticker before commissioning the chamber.

3.2 Guidelines for safe lifting and transportation

After operation, please observe the guidelines for temporarily decommissioning the chamber (chap. 17.2).

  	 CAUTION
	<p>Sliding or tilting of the chamber. Damage to the chamber.</p>
	<p>Risk of injury by lifting heavy loads.</p> <ul style="list-style-type: none"> ➤ Transport the chamber in its original packaging only. ➤ For moving or shipping, secure the oven with transport straps. ⊘ Do NOT lift or transport the chamber using the door, the handle, or the lower housing. ➤ Lift chambers size 23 and 53 at the four lower corners with the aid of 4 people. ➤ Lift chambers size 115 with the aid of 6 people.

- Permissible ambient temperature range during transport: $-10\text{ °C} / 14\text{ °F}$ to $+60\text{ °C} / 140\text{ °F}$.

You can order transport packing for moving or shipping purposes from BINDER Service.

3.3 Storage

Intermediate storage of the chamber is possible in a closed and dry room. Observe the guidelines for temporary decommissioning (chap. 17.2).

- Permissible ambient temperature range during storage: $-10\text{ °C} / 14\text{ °F}$ to $+60\text{ °C} / 140\text{ °F}$.
- Permissible ambient humidity: max. 70 % r.H., non-condensing

When after storage in a cold location you transfer the chamber to its warmer installation site, condensation may form. Before start-up, wait at least one hour until the chamber has attained ambient temperature and is completely dry.

3.4 Location of installation and ambient conditions

Set up the VDL vacuum drying oven on a flat, even and non-flammable surface, free from vibration, in a well-ventilated, dry location and align it using a spirit level. The site of installation must be capable of supporting the chamber's weight (see technical data, chap. 19.2). The chambers are designed for setting up inside a building (indoor use).

	CAUTION
	<p>Danger of overheating. Damage to the chamber.</p> <ul style="list-style-type: none"> ⊘ Do NOT set up chambers in non-ventilated recesses. ➤ Ensure sufficient ventilation for dispersal of the heat.

- Permissible ambient temperature range during operation: $+18\text{ °C} / 64\text{ °F}$ to $+32\text{ °C} / 90\text{ °F}$.

	<p>The ambient temperature should not be substantially higher than the indicated ambient temperature of $+22\text{ °C} \pm 3\text{ °C} / 71.6\text{ °F} \pm 5.4\text{ °F}$ to which the specified technical data relate. Deviations from the indicated data are possible for other ambient conditions.</p>
---	---

- Permissible ambient humidity: 70 % r.H. max., non-condensing.
- Installation height: max. 2000 m / 6562 ft above sea level.

When placing several chambers of the same size side by side, maintain a minimum distance of 250 mm / 9.8 in between each chamber. Wall distances: rear 100 mm / 3.9 in, sides 135 mm / 5.3 in. Spacing above and behind the chamber of at least 100 mm / 3.9 in must also be maintained.

	CAUTION
	<p>Danger by stacking.</p> <p>Damage to the chambers.</p> <p>∅ Do NOT place vacuum drying ovens on top of each other.</p>

To completely separate the chamber from the power supply, you must disconnect the power plug. Install the chamber in a way that the power plug is easily accessible and can be easily pulled in case of danger.

Do not install or operate the vacuum drying oven VDL in potentially explosive areas.

	DANGER
	<p>Explosion hazard.</p> <p>Danger of death.</p> <p>∅ Do NOT operate the chamber in potentially explosive areas.</p> <p>➤ KEEP explosive dust or air-solvent mixtures AWAY from the vicinity of the chamber.</p>

If no pumps are used for pumping from zone 0 or zone 1, i.e. if the vacuum pump is only suitable for category 3 / zone 2, measures for an explosion-preventing decoupling (explosion barrier, flame arrester, flame flash-through barrier acc. to EN ISO 16852:2010) between the inner chamber and the vacuum pump are required. For installing a flame arrester, please contact the BINDER INDIVIDUAL Customized Solutions team.

	Follow country-specific regulations for explosion protection.
---	---

Before commissioning the chamber, connect the vacuum drying oven to the compressed air supply.

	Without the necessary compressed air connection, the chamber will remain without power and function.
---	--

If you ordered the option “vacuum module with chemical membrane pump”, the pump will be delivered in a separate box and must be fitted into the module and connected at the place of installation (chap. 15.3).



	During operation a fire extinguisher must be available.
---	---

The maximum permissible ambient temperature of the vacuum pumps delivered by BINDER is 40 °C / 104°F.

Notes when using inert gas:

When operating the VDL safety vacuum drying oven with inert gas, correctly follow the technical ventilation measures, as described in the DGUV guidelines 213-850 on safe working in laboratories (formerly BGI/GUV-I 850-0, BGR/GUV-R 120 or ZH 1/119, issued by the employers' liability insurance association) (for Germany).

During operation with inert gas, the chamber is supplied with an oxygen displacing gas (e.g. N₂). Inert gases in high concentrations are hazardous to health. They are colorless and almost odorless and therefore practically imperceptible. Inhalation of inert gases can cause drowsiness up to respiratory arrest. When the O₂ content of the air decreases below 18%, there is risk of death from lack of oxygen. Any gas that might escape has to be led out via good room ventilation or a suitable exhaust system.

	 WARNING
	<p>High concentration of inert gas. Risk of death by suffocation.</p> <ul style="list-style-type: none"> ⊘ Do NOT set up chambers in non-ventilated recesses. ➤ Ensure technical ventilation measures. ➤ Respect the relevant regulations for handling these gases. ➤ When decommissioning the vacuum drying oven, shut off the inert gas supply: Close valve (6).

4. Installation and connections

4.1 Vacuum expansion racks

The low-loss heat transfer to the material occurs via the patented aluminum vacuum expansion racks (also available in stainless steel as an option). The strong tension causes the racks to fit tightly against the interior wall and their large-surface contact area ensures rapid and effective heat transfer.

The removable rack holders allow for easy positioning.

You can also remove the expansion racks for easy cleaning. Do not remove them too often in order to prevent wear.



Figure 12: Using the expansion racks

- Pushing the locking lever: The expansion rack is released and can be removed.
- Pulling the locking lever: The expansion rack is pressed against the inner chamber walls.

	<p>Following each new tightening of an expansion rack, check that the lateral parts of the rack fit closely over their whole surface to the inner chamber wall. This is necessary in order to ensure the specified temperature exactitude.</p>
---	--

	CAUTION
	<p>Invalid calibration.</p> <ul style="list-style-type: none"> ⊘ Do NOT change between aluminum and stainless steel racks ➤ Use the delivered expansion racks only

4.2 Vacuum connection

Always connect the VDL vacuum drying oven to a vacuum pump or to a domestic vacuum system. For this purpose, the vacuum connection (13) with small flange DN16 must be connected to the back of the chamber at the top with the vacuum pump or domestic vacuum system via a vacuum suction hose. For connecting to the chamber, BINDER recommends the connection kits VP4 (Art. no. 8012-0621) or VP5 (Art. no. 8012-0622), (chap. 15.1).

With the option “stainless steel tubing” between the vacuum oven and vacuum module, the vacuum connection is already located inside the vacuum module.



	<p>Vacuum pumps with a suction capacity of 1-30 m³/h are suitable for the VDL vacuum drying oven. Permissible end vacuum: 10⁻² mbar / 0.0003 inHg.</p>
---	--

For use of vacuum pumps in the European Union, note the following points:

- Units that will be operated in potentially explosive areas have to meet the requirements of ATEX Directive 2014/34/EU.
- If combustible solvent will be introduced into the inner chamber, the vacuum pump must be constructed in a suitable explosion-proof manner. The mixtures extracted from the drying chamber must be carried away making sure that there is no danger by ignition of these atmospheres. Otherwise use flame arresters.



	<p>Follow the safety instructions of the pump manufacturer.</p>
--	---

In case of an explosion, the flame may be suctioned into the in-house vacuum system and result in further explosions.

	 DANGER
	<p>Danger due to flame flash-through with in-house vacuum system. Danger of death.</p> <p>➤ We recommend installing a flame arrester (flame flash-through barrier) according to EN ISO 16852:2010 between the vacuum drying oven and the in-house vacuum system.</p>

For installing a flame arrester, please contact the BINDER INDIVIDUAL team.

In the event of an error, sparking in the pump motor or the switching elements, electrostatic discharges, as well as hot pump parts can ignite solvent vapors. Minimize this risk by using an ATEX Directive 2014/34/EU compliant vacuum pump suitable for suction from Zone 0 or 1 and, if appropriate, from the zone of its installation site.



	 DANGER
	<p>Ignition of emerging solvent vapors due to sparking in the pump motor or the switching elements, electrostatic discharges, hot pump parts.</p> <p>Explosion hazard.</p> <p>Danger of death.</p> <ul style="list-style-type: none"> ➤ Use only suitable, explosion-proof pumps ➤ Operate the pump in a stationary position and secure it so it is immobile. ➤ Install a fixed and conductive suction line to the vacuum connection (13). ➤ Install a fixed and conductive exhaust pipe in case it may conduct ignitable solvent concentrations. This should be avoided by sufficient solvent condensation e.g., in an exhaust waste vapor condenser ➤ When using ATEX Directive 2014/34/EU non-compliant pumps: Provide a current-dependent, delayed protective device for the pump (for the triggering time of this protective device, see the manufacturer's specifications). The protective and monitoring device must not be able to independently turn on again or be released. ➤ When using ATEX Directive 2014/34/EU non-compliant pumps: Install the switch gear box outside the hazardous area or provide it with explosion protection. ➤ Assure that there is equipotential bonding between the pump housing and the housing of the VDL vacuum drying oven via the connected equipment grounding conductors of both units.

	The ATEX Directive 2014/34/EU compliant pumps offered by BINDER provide an integral protective device.
---	--

	The ATEX Directive 2014/34/EU compliant pumps offered by BINDER provide an integral explosion proof switch.
---	---

	Make sure that the vacuum source is designed for a gas inlet temperature corresponding to the used drying temperature, or take appropriate measures to cool down the extracted vapor before it enters into the vacuum source.
---	---

The ATEX Directive 2014/34/EU compliant vacuum pumps offered by BINDER are designed for a gas inlet temperature of 40 °C / 104°F max. Do NOT exceed this temperature. If the gas inlet temperature is too high and then becomes even warmer by compression in the pump, the resulting temperature (of the gas-solvent mixture inside the pump) could exceed the solvent's temperature class and ignition temperature.

	 DANGER
	<p>Exceeding the gas inlet temperature.</p> <p>Exceeding the ignition temperature of the solvent.</p> <p>Risk of ignition and explosion.</p> <p>Damage to the vacuum pump.</p> <p>Danger of death.</p> <ul style="list-style-type: none"> ⊘ Do NOT exceed a set-point temperature of 40 °C / 104°F. ➤ With set-point temperature > 40 °C / 104°F take appropriate measures to cool down the extracted vapor before it enters into the vacuum pump.

4.2.1 Notes regarding use of vacuum pumps of other manufacturers



Connection to a vacuum source

Connect the vacuum connection (13) (small flange DN 16) at the back of the chamber at the top to a vacuum pump or domestic vacuum system via a vacuum conduit or fixed vacuum tubing.

	<p>Within the European Union, units that will be operated in potentially explosive areas have to meet the requirements of ATEX Directive 2014/34/EU. Follow the safety instructions in chap. 1.5.</p>
---	---

	<p style="text-align: center;">CAUTION</p> <p>Excessive low pressure. Risk of technical defects.</p> <ul style="list-style-type: none"> ⊘ The end vacuum must NOT fall below the permissible level of 10^{-2} mbar / 0.0003 inHg. ➤ Install a pump according to the permissible end vacuum or limit it via a vacuum controller.
---	--



Extracted vapors can have a health damaging and/or corrosive effect on the chamber and pump.

	<p style="text-align: center;"> CAUTION</p> <p>Release of extracted vapors. Damage to health. Corrosion of oven and pump.</p> <ul style="list-style-type: none"> ➤ Conduct the extracted vapors e.g., into a fume extractor facility. Connect a suitable hose to the vacuum pump outlet (that may be located in the vacuum module).
--	---

4.3 Inert gas connection

When operating the VDL vacuum drying oven with inert gas, correctly follow the technical ventilation measures, as described in the DGUV guidelines 213-850 on safe working in laboratories (formerly BGI/GUV-I 850-0, BGR/GUV-R 120 or ZH 1/119, issued by the employers' liability insurance association) (for Germany).

During operation with inert gas, the chamber is supplied with an oxygen displacing gas (e.g. N₂). Inert gases in high concentrations are hazardous to health. They are colorless and almost odorless and therefore practically imperceptible. Inhalation of inert gases can cause drowsiness up to respiratory arrest. When the O₂ content of the air decreases below 18%, there is risk of death from lack of oxygen. Any gas that might escape has to be led out via good room ventilation or a suitable exhaust system.

	<p style="text-align: center;"> WARNING</p> <p>High concentration of inert gas. Risk of death by suffocation.</p> <ul style="list-style-type: none"> ⊘ Do NOT set up chambers in non-ventilated recesses. ➤ Ensure technical ventilation measures. ➤ Respect the relevant regulations for handling these gases. ➤ When decommissioning the vacuum drying oven, shut off the inert gas supply: Close valve (6).
---	---

Connect the inert gas supply to the inert gas connection (adapter with hose olive diameter 8 mm / 0.31 in) via a pressure reducer. Screw the enclosed adapter with hose olive on the thread (11) at the chamber rear. Set the pressure reducer to a pressure slightly above ambient pressure. Make sure that the pressure reducer will open. Do not alter this setting in order to avoid perturbation inside the oven and the release of large quantities of inert gas after flooding the VDL.

	CAUTION
	<p>Overpressure in the inner chamber.</p> <p>Turbulence of the charging material.</p> <p>⊘ Do NOT modify the atmospheric pressure setting.</p>

4.4 Compressed air / inert gas connection for sweeping the area for electrical equipment

The compressed air flows through the area for electrical equipment as well the preheating chamber, which prevents a possible concentration of a solvent-containing atmosphere in the area for electrical equipment. You can alternatively connect inert gas or nitrogen to the compressed air connection. Use only dry gas.

In order to avoid that any oil coming from the compressed-air piping enters the vacuum drying oven, the compressor of the compressed air system must be equipped with an oil separator, or the compressed air system must be constructed oil-free. The condensate separator of the compressed air connection separates water and soil from the compressed-air piping, thus leading to compressed air quality class 4 acc. to ISO 8573-1. However, it does not prevent oil penetrating from the compressed air system, e.g. the compressed air compressor, into the compressed-air piping. The condensate separator is equipped with a manual condensate outlet (chap. 16.1).

Connection: Before commissioning, the existing compressed air unit must be connected on the right side of the chamber (hose olive \varnothing 8 mm) to a compressed air line (compressed air system) or to an inert gas supply. There must be an overpressure of at least 1.5 bar / 44.3 inHg in the supply network. The maximally permitted pressure is 7 bar / 206.7 inHg.

Immediately after connecting the compressed air or inert gas supply, the area for electrical equipment of the oven will be swept at 5 liters per minute. This air or inert gas quantity is used and then released into the surrounding atmosphere permanently; independent of the oven's operating state. Therefore the compressed air or inert gas connection on the building side should be equipped with a stop valve that can be used to cut off the gas supply, after having operated the drying oven.



Figure 13: Compressed air connection with condensate separator

If solvent-containing air penetrates the electrical area of the chamber, explosions may result.

	DANGER
	<p>Solvent-containing air penetrating the electrical area of the chamber.</p> <p>Explosion hazard.</p> <p>⊘ Do NOT take the air for the compressed air supply from explosive atmospheres.</p>



	<p>If the chamber is not connected to the compressed air supply, or if the specified overpressure is not reached, it is impossible to start the VDL vacuum drying oven.</p>
---	---

	<p>The compressed air connection is preset at the factory. Do NOT change the setting. In delivery condition of the oven, this setting is protected by a cover with seal.</p> <p>If the seal is broken, please inform BINDER Service to have the setting checked and to reinstall the cover with seal.</p>
---	---

Notes when using inert gas:

When operating the VDL vacuum drying oven with inert gas, correctly follow the technical ventilation measures, as described in the DGUV guidelines 213-850 on safe working in laboratories (formerly BGI/GUV-I 850-0, BGR/GUV-R 120 or ZH 1/119, issued by the employers' liability insurance association) (for Germany).

During sweeping the area for electrical equipment with inert gas, the chamber is supplied with an oxygen displacing gas (e.g. N₂). Inert gases in high concentrations are hazardous to health. They are colorless and almost odorless and therefore practically imperceptible. Inhalation of inert gases can cause drowsiness up to respiratory arrest. When the O₂ content of the air decreases below 18%, there is risk of death from lack of oxygen. Any gas that might escape has to be led out via good room ventilation or a suitable exhaust system.

	 WARNING
	<p>High concentration of inert gas. Risk of death by suffocation.</p> <ul style="list-style-type: none"> ⊘ Do NOT set up chambers in non-ventilated recesses. ➤ Ensure technical ventilation measures. ➤ Respect the relevant regulations for handling these gases. ➤ When decommissioning the vacuum drying oven, shut off the inert gas supply: Close valve (6).

4.5 Electrical connection



- The VDL vacuum drying oven comes with a fixed power connection cable that has a length of 1800 mm / 5.9 ft. and a shockproof plug. The socket must also provide a protective conductor.
- Chamber fuse 10 Amp
- Power supply voltage 230 V (1N~) ± 10 %, 50/60 Hz
- Prior to connection and start-up, check the power supply voltage. Compare the values to the specified data located on the chamber's type plate (left side of the chamber, bottom right-hand, chap. 1.4).
- We recommend the use of a residual current circuit breaker.
- When connecting, please observe the regulations specified by the local electricity supply company as well as the VDE directives (for Germany)
- Pollution degree (acc. to IEC 61010-1): 2
- Over-voltage category (acc. to IEC 61010-1): II

	CAUTION
	<p>Danger of incorrect power supply voltage. Damage to the equipment.</p> <ul style="list-style-type: none"> ➤ Check the power supply voltage before connection and start-up. ➤ Compare the power supply voltage with the data indicated on the type plate.

See also electrical data (chap. 19.2).

	<p>To completely separate the chamber from the power supply, you must disconnect the power plug. Install the chamber in a way that the power plug is easily accessible and can be easily pulled in case of danger.</p>
---	--

5. Start up

	 DANGER
<p>Solvent-containing air penetrating and concentration in the electrical area of the chamber.</p> <p>Explosion hazard.</p> <ul style="list-style-type: none"> ➤ Before turning on the chamber via the key switch (1), sweep the area for electrical equipment at least 15 minutes with compressed air or inert gas. Sweeping the area for electrical equipment must take place during the entire operation, as otherwise the VDL vacuum drying oven will shut off at all poles. 	

After connecting the supply lines (chap 4) and checking all safety instructions and conditions of installation and safe operation, turn on the chamber via the key switch (1):

- **Position 0:** Oven is not operating
No consumption of compressed air or inert gas in the area for electrical equipment. If the fine dosage valve (6) is open, inert gas may be used and can reach the ambient air.
- **Position I:** Oven is operating

	<p>If no indication appears in the display of the program controller RD3, the compressed air supply is probably not properly connected.</p>
---	---

Warming chambers may release odors in the first few days after commissioning. This is not a quality defect. To reduce odors quickly we recommend heating up the chamber to its nominal temperature for one day and in a well-ventilated location.

5.1 Settings at the RD3 program controller

After turning the chamber on with the key switch (1) the controller is in Normal Display / Fixed value operation mode.

Depending on the temperature value entered before, LED (7a) is lit if the heating is active, or no LED is lit if the actual temperature is equal to or above the set-point.

In **Display 1** of the controller the actual temperature value is displayed.

- With inactive week program timer:

In **Display 2** of the controller the actual date and time are displayed. Example:

15.05.06 13:52

- With active week program timer:

In **Display 2** of the controller the actual date and time and the states of the week program timer channels are displayed. Examples:

15.05.06 13:52 - -	15.05.06 13:52 - □	15.05.06 13:52 □ -	15.05.06 13:52 □ □
Channel 1 Off, Channel 2: Off	Channel 1: Off, Channel 2: On	Channel 1: On, Channel 2: Off	Channel 1 On, Channel 2: On

	<p>Do not use the week program timer when using explosive substances. Make sure in this case that the week program timer has been deactivated in the User Level (chap. 10).</p>
---	---

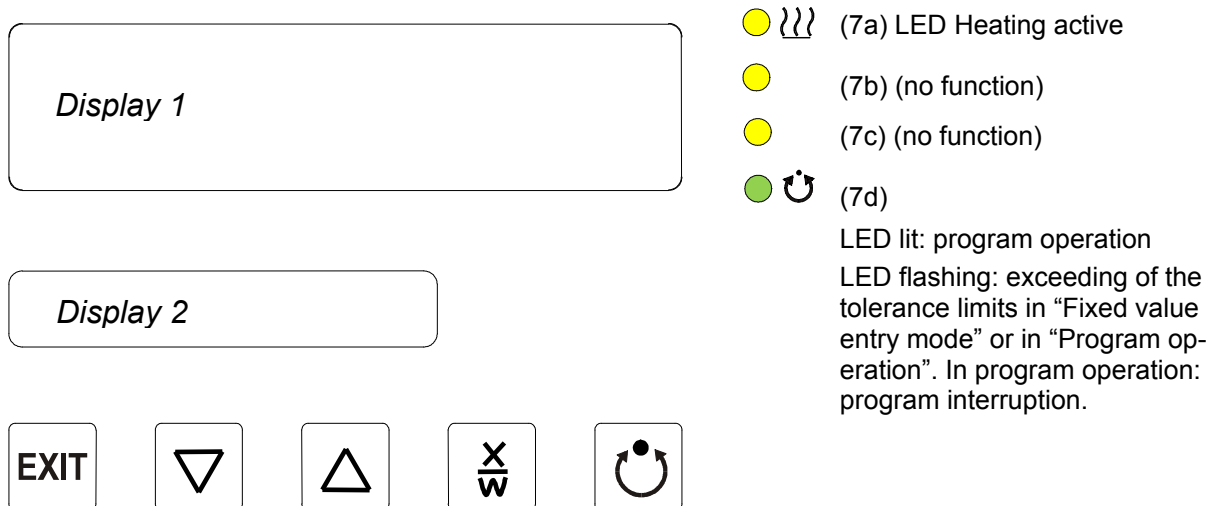



Figure 14: RD3 program controller

The program controller RD3 permits programming temperature cycles.

You can enter two programs with up to 10 sections each or one program with up to 20 sections (setting in the user level, chap. 10).

 When changing from 2 programs to 1 program or vice-versa, existing programs are deleted.

The maximum length of an individual program section can be set to either 99 h 59 min or to 999 h 59 min (setting in the user level, chap. 10). This setting is then valid for all program sections.

Programming can be done directly through the keypad of the controller or graphically through the software APT-COM™ 3 DataControlSystem (option, chap. 15.6) specially developed by BINDER.

5.2 General indications

The program controller RD3 offers several functional levels:

Normal Display / Fixed value operation:

- Display of the temperature actual value (display 1) and of the actual date and time (display 2).
- The oven is in fixed value operating mode, equilibrating to the entered set-points.

Fixed value entry mode (chap. 6)

- Entry of the temperature set-point for fixed value operating mode
- Entry of temperature set-points 1 and 2 for week program operation

Program editor (chap. 8)

- You can enter two programs with up to 10 sections each or one program with up to 20 sections (selection in the user level, chap. 10). Entry of temperature set-points in all program sections (chap. 8.1).
- Deleting a program section (chap. 8.4)

Program start level (chap. 9)

- Selection of an entered program
- Entry of settings affecting the program course, as “start delay time” or “number of program cycles”
- Program start

Week program editor (chap.7)

- Setting the shift points



Do not use the week program timer when using explosive substances. Make sure in this case that the week program timer has been deactivated in the User Level (chap. 10).

User level (chap. 10)

- User specific controller settings
- Setting the real time clock

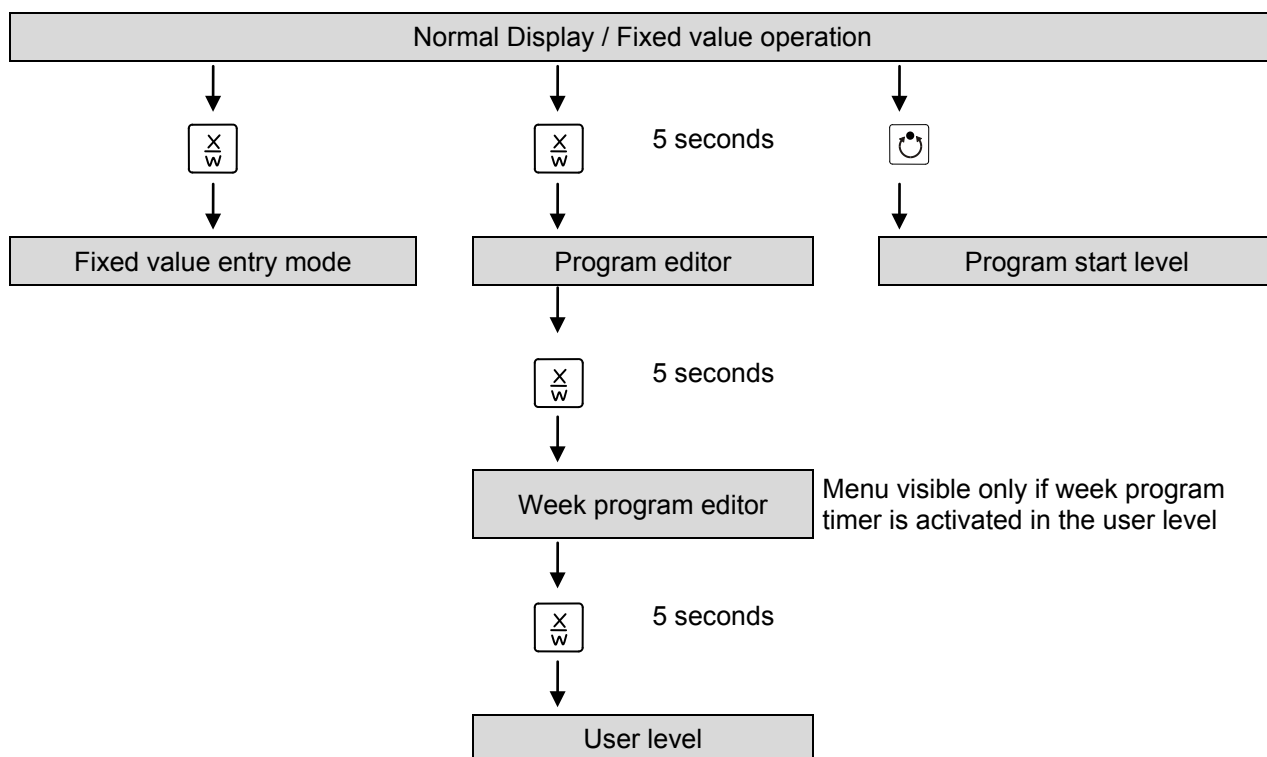



If no button is touched within more than 120 sec., the controller returns from the current level to Normal Display.

To avoid condensation inside the chamber and in the suction system, select an appropriate vacuum source to ensure its sufficient performance in relation to the released amount of steam. Coordinate drying temperature, suction performance of the vacuum source and the amount of charging material.

6. Fixed value entry mode

Solvents and resulting vapors can ignite at excessive drying temperatures.

	 DANGER
<p>Excess drying temperature. Ignition and explosion hazard.</p> <ul style="list-style-type: none"> ➤ Determine the maximum drying temperature in relation to the ignition temperature of the solvent according to the information panel "Temperature setting" (chap. 2.5). Do NOT exceed this temperature when presetting the set point on the RD3 temperature controller. ➤ In case of solvent mixtures, use the ignition temperature of the material with the lowest ignition temperature. ➤ Before starting the drying process, set the temperature safety device (chap. 12) to the maximum permitted drying temperature according to the information panel "Temperature setting" (chap. 2.5). ➤ Start the drying process. The heating is only released when a vacuum of $125 \pm 25 \text{ mbar} / 3.69 \pm 0.74 \text{ inHg}$ or below is reached. 	



If you do not want to use the week program timer, deactivate it (factory setting, setting in the user level, chap. 10) before entering any set-points.



Basic entry principle: Access the individual parameters with button X/W. Enter the value with the arrow keys. A value flashing once after 2 seconds indicates that it has been applied by the controller.

→ **Normal Display**

Display 1 shows	e.g. 39.8 °C	(actual temperature value)
Display 2 shows	e.g. 15.05.06 13:52 --	(actual date and time)
		(actual switching state of week program timer channel 1: Off, channel 2: Off, visible only if week program timer is activated in the user level, chap. 10)



Press key  ↓

Display 1 shows	e.g. 40.0 °C	(actual temperature set-point 1)
Display 2 shows	SP1 TEMPERATURE	(variable: temperature in °C)

Enter temperature set-point in °C using arrow keys   ↓ Value is shown in display 1.

Press key  ↓

Display 1 shows	e.g. 50.0 °C	(actual temperature set-point 2)
		(visible only if week program timer is activated in the user level, chap. 10)
Display 2 shows	SP2 TEMPERATURE	(variable: temperature in °C)

Enter temperature set-point in °C using arrow keys   ↓ Value is shown in display 1.

Press key  ↓

If no button is pressed within more than 120 sec, or if the "EXIT" button is pressed, the controller changes to Normal Display.



When changing the set-point, check the setting of the safety device (chap. 12).



The values entered in fixed-value entry mode remain valid after program run-off and are then equilibrated.

If the week program timer is active, depending on the running week program another set-point (SP2) may be targeted. Resulting high temperatures may exceed the maximum permissible drying temperature of a solvent in the drying material. Therefore, deactivate the week program timer if you do not use it (default setting, setting in the User level, chap. 10).



Do not use the week program timer when using explosive substances. Make sure in this case that the week program timer has been deactivated in the User Level (chap. 10).



DANGER

Exceeding the ignition temperature of a solvent after the program ends.



Risk of fire and explosion.

Danger of death.

- Prior to using explosive substances, deactivate the week program timer in the User Level (chap. 10).

7. Week program editor

 Do not use the week program timer when using explosive substances. Make sure in this case that the week program timer has been deactivated in the User Level (chap. 10).

	 DANGER
	<p>Exceeding the ignition temperature of a solvent after the program ends.</p> <p>Risk of fire and explosion.</p> <p>Danger of death.</p> <p>➤ Prior to using explosive substances, deactivate the week program timer in the User Level (chap. 10).</p>

The Week program editor allows defining up to 4 shift point for each week day. A shift point defines a moment and the switching state ON or OFF of the channels that become active in this instance.

Channel function:

- Channel 1 On = Set-point SP2 is equilibrated.
- Channel 1 Off = Set-point SP1 is equilibrated
- Channel 2 = reserve

 The week program timer is initially set to inactive (factory setting). Therefore, you need to activate the week program timer in the user level (chap. 10).

Normal Display

Display 1 shows	e.g. 39.8 °C	(actual temperature value)
Display 2 shows	e.g. 15.05.06 13:52 --	(actual date and time, actual state of week program timer channel 1: Off, channel 2: Off)

Press down key  ↓ for 5 sec



Display 1 shows	e.g. 0000	
Display 2 shows	PROGRAM EDITOR	(you are in the "program editor")

Press down key  ↓ for 5 sec

Display 1 shows	0000	Menu visible only if week program timer is activated in the user level (chap. 10)
Display 2 shows	WEEK PROG. EDITOR	(you are in the "week program editor")

Press program key  ↓

Display 1 shows	0000	
Display 2 shows	UserCod? 0000	(enter the user code, display flashes)

Enter the user code using arrow keys   ↓ e.g. **0001** (basic setting, adjustable in the user level, chap. 10).
Value is shown in both displays.

Automatically forward after 2 sec

Display 1 shows	0000	
Display 2 shows	Monday	(selection of day of the week) (actual selection: Monday)

Select the day of the week (Monday up to Sunday) with key  ↓ Day of the week is shown in display 2.

Press program key  ↓

Display 1 shows	0000	
Display 2 shows	Shiftpt.	(no function)

Press program key  ↓

Display 1 shows	0000	
Display 2 shows	Shiftpt. 1	(selection of the shift point) (actual shift point: 1)



Select the shift point (1 up to 4) with key  ↓ Value is shown in display 2.

Press program key  ↓

Display 1 shows	e.g. --:--	(time of the selected shift point)
Display 2 shows	S1: --:--	(actual selection of the shift point: S1) (actual setting: shift point not programmed)

Press program key  ↓

Display 1 shows	--:--	(time of the selected shift point)
Display 2 shows	Time --:--	(entry of the time of the selected shift point) (actual setting: shift point not programmed)

Enter the time (hh:mm) using arrow keys   ↓ Value is shown in display 2.

Press key  ↓

Display 1 shows	0000	
Display 2 shows	Ch1 = SP2: Off	(entry of the state of channel 1) (actual setting: Off)

Enter the state of channel 1 (On or Off) using arrow keys   ↓ Setting is shown in display 2.

Press key  ↓

Display 1 shows	0000	
Display 2 shows	Channel 2: Off	(entry of the state of channel 2) (no function) (actual setting: Off)

Enter the state of channel 2 (On or Off) using arrow keys   ↓ Setting is shown in display 2.

Press key  ↓

Press key **EXIT** ↓

Display 1 shows	e.g., 08.30	(time of the selected shift point)
Display 2 shows	S1: 08:30 --	(actual selection of the shift point: S1) (actual setting: time 08.30, channels Off)

Press program key  ↓

Press key **EXIT** twice ↓

Select the next shift point

Select the next day of the week

To exit the menu, Press several times key **EXIT** or wait for 120 seconds. Controller returns to normal display.

7.1 Program table template for the Week Program Editor

Program editor	
Program title	
Project	
Date:	

Day of the week	Time			Channel 1 (temperature) ON = SP2 OFF = SP1	Channel 2* ON OFF
	hh:mm	AM	PM		
Monday	S1				
	S2				
	S3				
	S4				
Tuesday	S1				
	S2				
	S3				
	S4				
Wednesday	S1				
	S2				
	S3				
	S4				
Thursday	S1				
	S2				
	S3				
	S4				
Friday	S1				
	S2				
	S3				
	S4				
Saturday	S1				
	S2				
	S3				
	S4				
Sunday	S1				
	S2				
	S3				
	S4				

- Channel 2 is non-functional in the standard chamber

7.2 Programming example of the Week program editor

7.2.1 Desired time function

During the day (12 hours) the oven shall maintain a temperature of +80 °C / 176°F, and during the night (12 hours) it shall cool down / stop heating (set-point 30 °C / 86°F).

This program shall automatically run during the whole year, i.e. it shall be programmed just once.

7.2.2 Proceeding overview

1. Settings in the User level (see chap. 10)

- Activating the week program timer
- Checking and, if necessary, setting the real time clock

2. Enter the set-points for the week program in “Fixed value entry mode” (see chap. 6)

Set-points for the example program:

SP1 (night / weekend) = 30 °C (Channel 1 ON = Controller adjusts to set-point SP2)

SP2 (day / week) = 80 °C (Channel 1 OFF = Controller adjusts to set-point SP1)

3. Enter the time program to the program editor

Program table for the example program:

Day of the week	Time			Channel 1 (temperature) ON = SP2 (day) OFF = SP1 (night)
		hh:mm	AM PM	
Monday	S1	06:00		ON
	S2	18:00		OFF
Tuesday	S1	06:00		ON
	S2	18:00		OFF
Wednesday	S1	06:00		ON
	S2	18:00		OFF
Thursday	S1	06:00		ON
	S2	18:00		OFF
Friday	S1	06:00		ON
	S2	18:00		OFF
Saturday	S1	06:00		ON
	S2	18:00		OFF
Sunday	S1	06:00		ON
	S2	18:00		OFF



Make sure that no other shift points have been pre programmed. If so, they must be deleted:
Set the time of the respective shift point to “--:--” using key .

7.2.3 Proceeding in detail

1. Settings in the user level

- Activating the week program timer
- Checking and, if necessary, setting the real time clock

Normal Display

Display 1 shows	e.g. 39.8 °C	(actual temperature value)
Display 2 shows	e.g. 15.05.06 13:52 --	(actual date and time, actual switching state of week program timer channel 1: Off, channel 2: Off)

Press down key  ↓ for 5 sec

Display 1 shows	e.g. 0000	
Display 2 shows	PROGRAM EDITOR	(you are in the "program editor")

Press down key  ↓ for 5 sec



Display 1 shows	0000	Menu visible only if week program timer is activated.
Display 2 shows	WEEK PROG. EDITOR	(you are in the "week program editor")

Press down key  ↓ for 5 sec

Display 1 shows	0000	
Display 2 shows	USER – LEVEL	(you are in the user level)

Press program key  ↓

Display 1 shows	0000	
Display 2 shows	UserCod? 0000	(enter the user code, display flashes)

Enter the user code using arrow keys   ↓ e.g. **0001** (basic setting, or the valid code in case it has been previously changed in this menu).
Value is shown in both displays.

Automatically forward after 2 sec

Display 1 shows	1	(actual address)
Display 2 shows	Adress 1	(entry of chamber address) (actual address: 1)

Press several times key  ↓ until **Prog.Clk** appears:

Display 1 shows	0000	
Display 2 shows	Prog.Clk Active	(Week program timer active or inactive?) (actual setting: Active)

Select "**Active**" using arrow keys   ↓ Setting is shown in display 2.

Press key  ↓

Display 1 shows	0000	
Display 2 shows	12h/24h 24h	(Display mode 12 hours or 24 hours?) (actual setting: 24h)



Press key  ↓

Display 1 shows	0000	
Display 2 shows	Date	(Main menu: Setting the date of the real time clock)

Press program key  ↓



↓

Display 1 shows	e.g. 2006	(Actual setting: 2006)
Display 2 shows	Year 2006	(Setting the year of the real time clock)

Set **year** (2006 up to 2050) using arrow keys   ↓ Setting is shown in display 2.



Press key  ↓

Display 1 shows	e.g. 5	(Actual setting: may)
Display 2 shows	Month 5	(Setting the month of the real time clock)

Set **month** (1 up to 12) using arrow keys   ↓ Setting is shown in display 2.

Press key  ↓

Display 1 shows	e.g. 15	(Actual setting: 15)
Display 2 shows	Day 15	(Setting the day of the real time clock)

Set **day** (1 up to 31) using arrow keys   ↓ Setting is shown in display 2.



Press key **EXIT** ↓

Press key  ↓

Display 1 shows	0000	
Display 2 shows	Time	(Main menu: Setting the time of the real time clock)



Press program key  ↓

Display 1 shows	e.g. 13	(Actual setting: 13, i.e. 1 p.m.)
Display 2 shows	Hour 13	(Setting the hour of the real time clock)

Set **hour** (0 up to 23) using arrow keys   ↓ Setting is shown in display 2.

Press key  ↓

Display 1 shows	e.g. 30	(Actual setting: 30 minutes)
Display 2 shows	Minute 30	(Setting the minute of the real time clock)

Set **minute**(0 up to 59) using arrow keys   ↓ Setting is shown in display 2.

Press several times key **EXIT** ↓ or wait for 120 seconds

Controller returns to normal display.

2. Enter the set-points for the week program in Fixed value entry mode (see chap. 6)

Set-points for the example program:

SP1 (night / weekend) = 30 °C (Channel 1 ON = Controller adjusts to set-point SP2)

SP2 (day / week) = 80 °C (Channel 1 OFF = Controller adjusts to set-point SP1)

Normal Display

Display 1 shows	e.g. 39.8 °C	(actual temperature value)
Display 2 shows	e.g. 15.05.06 13:52 --	(actual date and time, actual switching state of week program timer channel 1: Off, channel 2: Off)

Press key  ↓

Display 1 shows	30.0 °C	(actual temperature set-point 1)
Display 2 shows	SP1 TEMPERATURE	(variable: temperature in °C)

Enter temperature set-point **30 °C** using arrow keys   ↓ Value is shown in display 1.

Press key  ↓

Display 1 shows	80.0 °C	(actual temperature set-point 2)
Display 2 shows	SP2 TEMPERATURE	(variable: temperature in °C)

Enter temperature set-point **80 °C** using arrow keys   ↓ Value is shown in display 1.

Press the **EXIT** button. The controller changes to Normal Display.

3. Enter the time program to the week program editor

Normal Display

Display 1 shows	e.g. 39.8 °C	(actual temperature value)
Display 2 shows	e.g. 15.05.06 13:52 - -	(actual date and time, actual state of week program timer channel 1: Off, channel 2: Off)

Press down key  ↓ for 5 sec

Display 1 shows	e.g. 0000	
Display 2 shows	PROGRAM EDITOR	(you are in the program editor)

Press down key  ↓ for 5 sec

Display 1 shows	0000	
Display 2 shows	WEEK PROG. EDITOR	(you are in the week program editor)

Press program key  ↓

Display 1 shows	0000	
Display 2 shows	UserCod? 0000	(enter user code, display flashes)

Enter the user code using arrow keys   ↓ e.g. **0001** (basic setting, adjustable in the user level, chap. 10). Value is shown in both displays.

Automatically forward after 2 sec

Display 1 shows	0000	
Display 2 shows	Monday	(selection of day of the week) (actual selection: Monday)

Select the first day of the week (**Monday**) with key  ↓ Day of the week is shown in display 2.

Press program key  ↓

Display 1 shows	0000	
Display 2 shows	Shiftpt.	(no function)

Press program key  ↓

Display 1 shows	0000	
Display 2 shows	Shiftpt. 1	(selection of the shift point) (actual shift point: 1)

Select shift point **1** with key  ↓ Value is shown in display 2.

Press program key  ↓

Display 1 shows	e.g. --:--	(time of the selected shift point)
Display 2 shows	S1: --:--	(actual selection of the shift point: S1) (actual setting: shift point not programmed)

Press program key  ↓

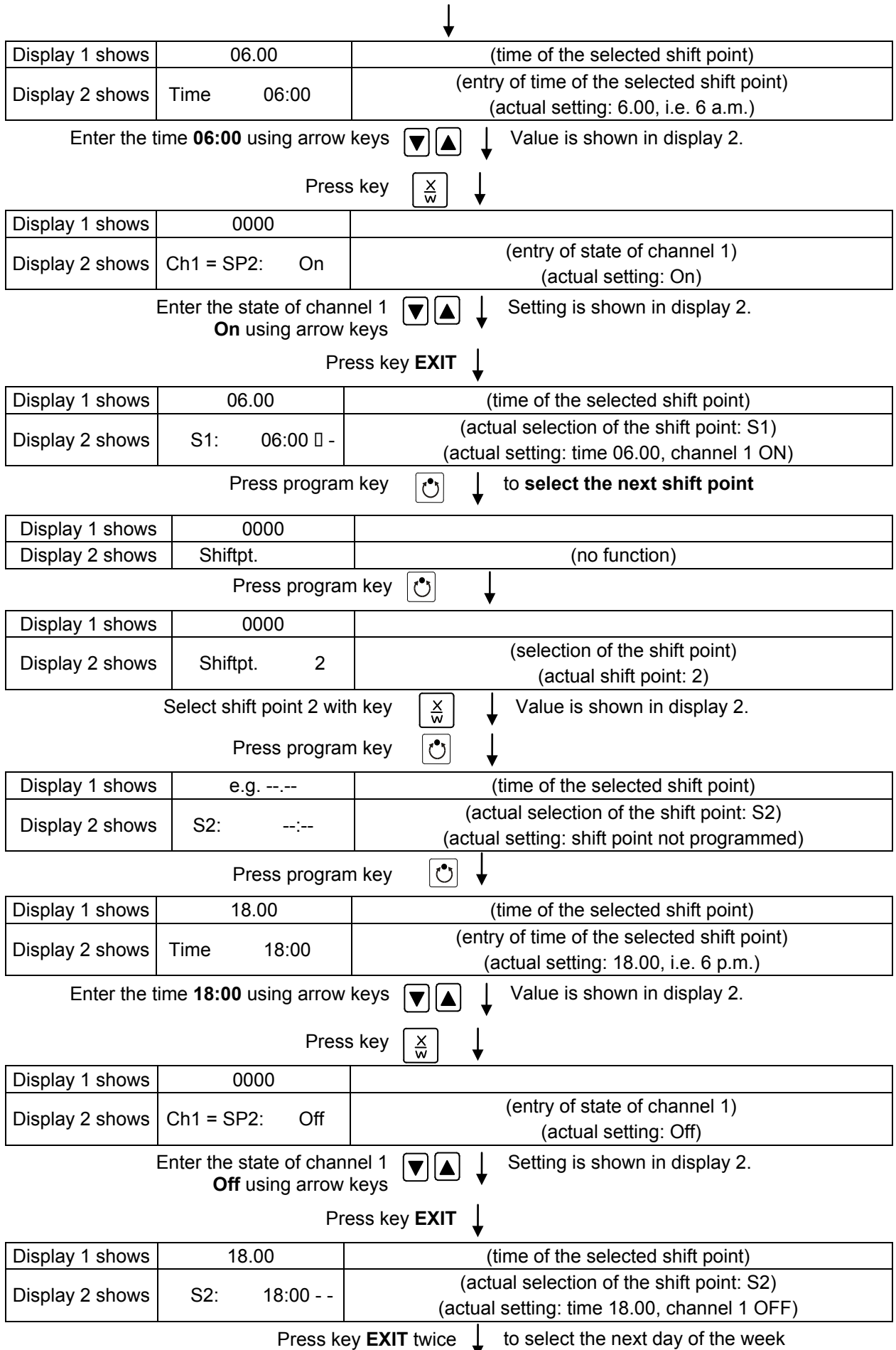

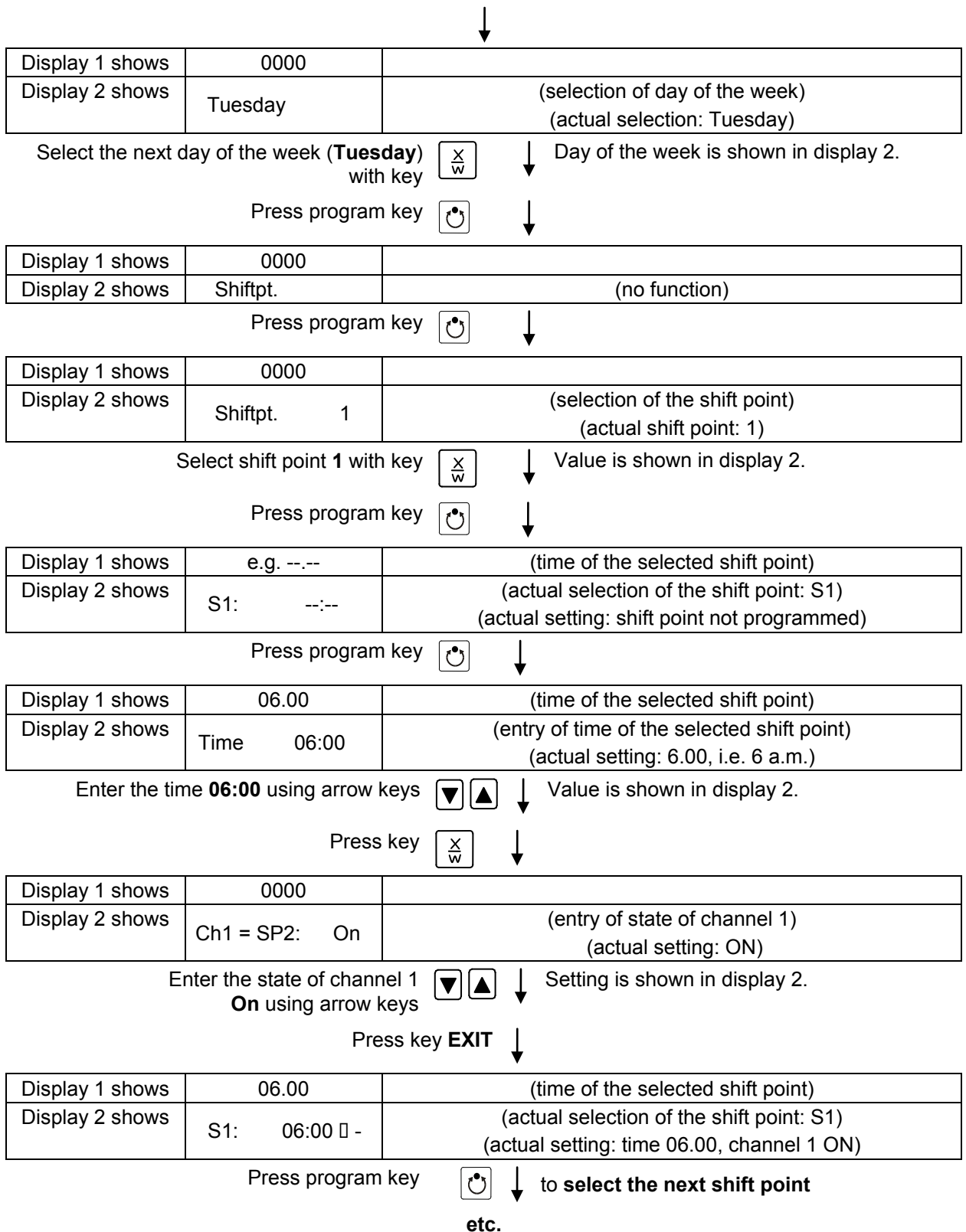

Following entry of the complete program:

Press several times key **EXIT** ↓ or wait for 120 seconds

Controller returns to normal display.

8. Program editor

8.1 Selecting between set-point ramp and set-point step

You can program various kinds of temperature transitions. In the user level (chap. 10) you can select between the settings “Ramp” (default setting) and “Step”.

	<p>Setting “Ramp” allows programming all kinds of temperature transitions. With setting “Step” the controller will equilibrate only to constant temperatures; programming ramps is no longer possible.</p>
---	--

	<p>Switching between settings “Ramp” and “Step” will influence all programs. Please note that this can cause the time courses of existing programs to change significantly.</p>
---	---

8.1.1 Programming with setting “Ramp” (default setting)

Set-points always refer to the start of a program section, i.e., at the beginning of each program section, the entered set-point is reached. During program section operation, the temperature gradually passes to the set-point entered for the subsequent program section.

You can program all kinds of temperature transitions by the appropriate design of the program section timing:

- **Gradual temperature changes “set-point ramp”**

The set-point gradually moves from one set-point to the one of the following program section during a given interval. The actual temperature value (X) follows the continually moving set-point (W) at any time.

Temperature ramps can be programmed in order to extend the heating up times. This may be necessary in order to avoid temperature stresses in the material during the heating up phase. Heating up times can be considerably slowed down by the use of temperature ramps.

- **Program sections with constant temperature**

The initial values of two subsequent program sections are identical; therefore the temperature remains constant during the whole time of the first program section.

- **Sudden temperature changes “set-point step”**

Steps are temperature changes (ramps) that occur during a very short interval. Two program sections with an identical set-point are followed by a section with a different set-point. If the duration of this transitional program section is very short (minimum entry 1 min), the temperature change will proceed rapidly in the minimum amount of time.

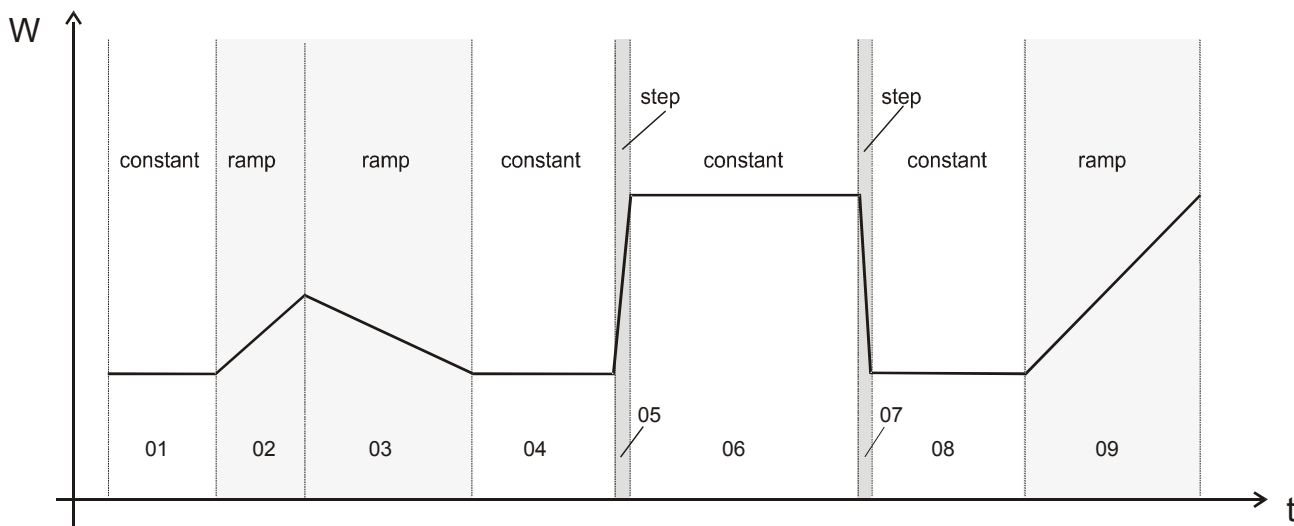
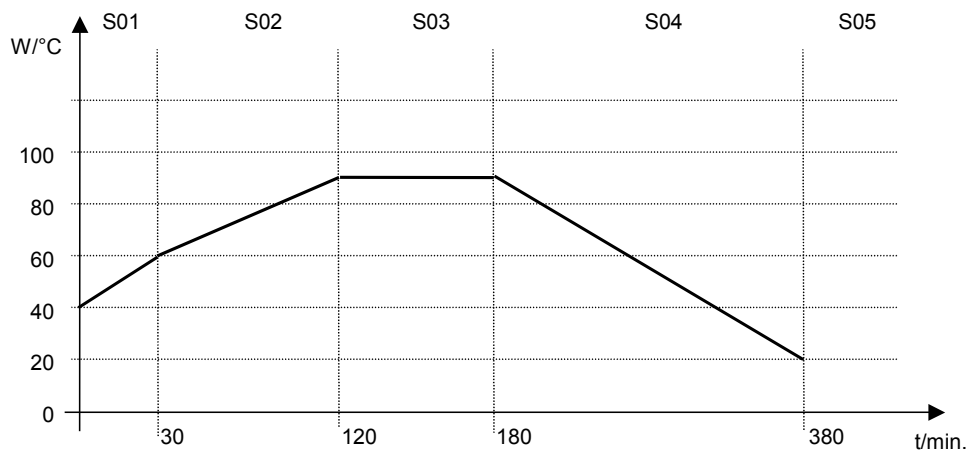

Figure 15: Possible temperature transitions
(with default setting “ramp” in the user level (chap. 10))

A heating up rate of 1.5 °C/min can be regarded as the realistic maximum.

If the oven is charged to full capacity, depending on the load, deviations from the specified heating up times may occur.

Program entry as set-point ramp (example):



Program table corresponding to the diagram (with default setting “Ramp”):

Section	Temperature set-point [°C]	Section length [hh.mm]
SEC	TEMP	TIME
S01	40	00:30
S02	60	01:30
S03	90	01:00
S04	90	03:20
S05	20	00:01

You can now enter the values of such a program table to the RD3 program controller (chap. 8.2).

Program entry as set-point step (example):

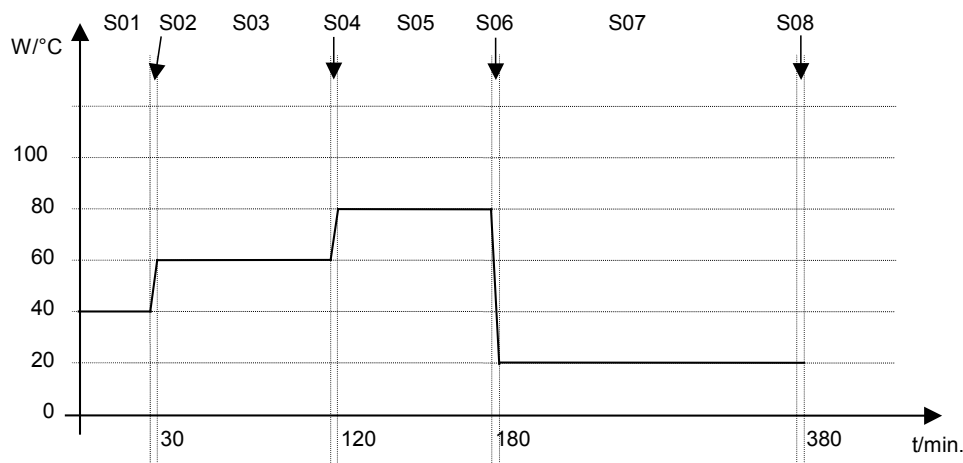

Program table corresponding to the diagram (with default setting "Ramp"):

Section	Temperature set-point [°C]	Section length [hh.mm]
SEC	TEMP	TIME
S01	40	00:30
S02	40	00:01
S03	60	01:30
S04	60	00:01
S05	80	01:00
S06	80	00:01
S07	20	03:20
S08	20	00:01

You can now enter the values of such a program table to the RD3 program controller (chap. 8.2).

Program the end point of the desired cycle with an additional section (in our examples S05 for set-point ramp and S08 for set-point step) with a section time of at least one minute. Otherwise, the program will stop one section too early because the program line is incomplete.

8.1.2 Programming with setting “step”

With setting “Step” selected, you don’t need to program the transition section in the Program Editor.



With setting “step” the controller will equilibrate only to constant temperatures; programming ramps is no longer possible.

The set-points are maintained constant for the duration of a program section. At the start of each program section, the chamber heats up with the maximum speed in order to attain the entered set-point

Program entry as set-point step (example):

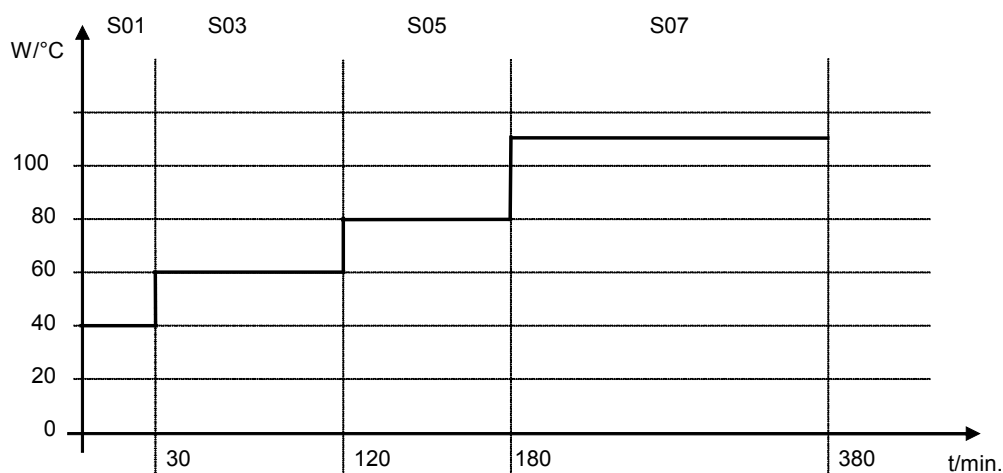

Program table corresponding to the diagram (with setting “Step”):

Section	Temperature set-point [°C]	Section length [hh.mm]
SEC	TEMP	TIME
S01	40	00:30
S02	60	01:30
S03	80	01:00
S04	20	03:20



You can now enter the values of such a program table to the RD3 program controller (chap. 8.2).

8.1.3 General notes on programming temperature transitions

When exceeding the tolerance limits set in the user level (chap. 10), the program is interrupted until the actual temperature value returns to within the tolerance range. During this program interruption, the LED (7d) flashes. Therefore, the duration of the program may be extended due to the programming of tolerances

The programming is saved even in case of a power failure or after turning off the chamber.

Solvents and the resulting vapors can ignite at excessive drying temperatures.

	 DANGER
<p>Excess drying temperature. Ignition and explosion hazard.</p> <ul style="list-style-type: none"> ➤ Determine the maximum drying temperature in relation to the ignition temperature of the solvent according to the information panel "Temperature setting" (chap. 2.5). Do NOT exceed this temperature when presetting the set point on the RD3 temperature controller. ➤ In the case of solvent mixtures, use the ignition temperature of the material with the lowest ignition temperature. ➤ Before starting the drying process, set the temperature safety device (chap. 12) to the permitted maximum drying temperature according to the information panel "Temperature setting" (chap. 2.5). ➤ The heating is only released when a vacuum of 125 ± 25 mbar / 3.69 ± 0.74 inHg) or below is reached. Only then should you start the program. 	

After program rundown the controller returns to fixed value operation showing Normal Display and equilibrates to the temperature value previously entered in fixed value entry mode.



Before starting the program, check the set-point value entered in fixed value entry mode. After program rundown temperature will equilibrate to this value.



Deactivate the week program timer (factory setting, setting in the user level, chap. 10) before starting a program.

8.2 Set-point entry for program operation

From Normal Display, press down button X/W for 5 sec to access the program editor. Then enter the set-points one after the other in all program sections of a selected program.

You can enter two programs with up to 10 sections each or one program with up to 20 sections (setting in the user level, chap. 10).

In order to avoid incorrect programming, we recommend entering the values of the program course into a table (template in chap. 8.3).

Example of program table (with default setting "Ramp"):

Section	Temperature set-point [°C] TEMP	Section length [hh.mm] TIME
S01	40	00:30
S02	60	01:30
S03	90	01:00
S04	90	03:20
S05	20	00:01

You can now enter the values of the program table to one of the program places of the RD3 program controller.

Step 1 – Selecting the program and the first program section to be entered:

Normal Display



Display 1 shows	e.g. 39.8 ^{°C}	(actual temperature value)
Display 2 shows	e.g. 15.05.06 13:52 --	(actual date and time, actual switching state of week program timer channel 1: Off, channel 2: Off)

Press down key  ↓ for 5 sec.

Display 1 shows	e.g. 0000	
Display 2 shows	PROGRAM EDITOR	(you are in the program editor)

Press program key  ↓

Display 1 shows	0000	
Display 2 shows	UserCod? 0000	(enter user code)

Enter user code using arrow keys   ↓ e.g. **0001**
(basic setting, adjustable in the user level, chap. 10).
Value is shown in both displays.

Automatically forward after 2 sec.



Display 1 shows	e.g. 01	(program P01 selected)
Display 2 shows	--- : --- PRG.	(program can be selected)
alternating	CONTINUE X/W	(information: to 1 st program section with X/W)

Select program P01 or P02 using arrow keys   ↓ Value is shown in display 1.



Press key  ↓

In the selected program P01 or P02, program sections can be selected:

Display 1 shows	e.g. 01	(section S01 selected)
Display 2 shows	P01: --- SEC.	Section S01 has already been created. Enter new set-points for the individual variables with button X/W
alternating	CONTINUE X/W	

or:

Display 1 shows	e.g. 01	(section S01 selected)
Display 2 shows	P01: --- SEC.	Section S01 has not yet been created. Enter set-points for the individual variables with button X/W
alternating	NEW SEC. X/W	

Select sections S01 to S10 or to S20 using   ↓
arrow keys

As long as no program section has been entered, the display switches back to 01 in case of any entry > 01, because all sections need to be entered one after the other, and each new section is created as NEWSEC.

Example: If three program sections have been already entered, the next section to be entered is S04. Before this, no section > S04 can be selected.





Next step –set-point entry in the desired program sections:

Basic entry principle: Access the parameters of individual program sections with button X/W one after the other. Enter the values of the individual parameters with the arrow keys. A value flashing once after 2 seconds indicates that it has been adopted by the controller. If several parameters are to be skipped (e.g. in order to change a parameter in a posterior program section), the parameters can be rapidly jumped over by holding down the X/W key. If no button is pressed for more than 120 sec the controller switches back to Normal Display. The program entered to this point remains stored.

Press key  ↓

Display 1 shows	e.g. 40.0 ^{°C}	(actual temperature set-point)
Display 2 shows alternating	S01: TEMP 40.0	(variable: temperature in °C)
	CONTINUE X/W	(information: go on with X/W)

Enter temperature set-point of S01 in °C using arrow keys   ↓

Press key  ↓

Display 1 shows	e.g. 00.30	(actual section length set-point)
Display 2 shows alternating	S01: TIME 00:30	(variable: section length in hh:mm)
	CONTINUE X/W	(information: go on with X/W)

Enter section length set-point of S01 in hh.mm using arrow keys   ↓ Value is shown in both displays.



Press key  ↓

Selecting the next program sections to be entered



Display 1 shows	e.g. 02	(section S02 selected)
Display 2 shows alternating	P01: --- SEC.	Section S02 has already been created.
	CONTINUE X/W	Enter new set-points for the individual parameters with X/W.

or:

Display 1 shows	e.g. 02	(section S02 selected)
Display 2 shows alternating	P01: --- SEC.	Section S02 has not yet been created.
	NEW SEC. X/W	Enter set-points for the individual parameters with X/W

Select the next section to be entered using arrow keys   ↓

Display 1 shows	e.g. 60.0 ^{°C}	(actual temperature set-point)
Display 2 shows alternating	S02:TEMP 60.0	(variable: temperature in °C)
	CONTINUE X/W	(information: go on with X/W)

Enter the temperature set-point of S02 in °C using arrow keys   ↓

Etc.

If all sections up to S10 or up to S20 have been programmed, section S01 follows again. In order to quit the entry mode, press the “EXIT” button several times or wait 120 sec. → the controller will then return to Normal Display.



When changing the set-point, check the setting of the safety device (chap. 12).

8.3 Program table template

Program editor	
Program title	
Project	
Program No.	
Date:	

Section	Temperature set-point [°C]	Section length [hh.mm]
SEC	TEMP	TIME
S01		
S02		
S03		
S04		
S05		
S06		
S07		
S08		
S09		
S10		
S11		
S12		
S13		
S14		
S15		
S16		
S17		
S18		
S19		
S20		

8.4 Deleting a program section

A program section is deleted from the program by setting the section duration to Zero.



Normal display

Press down key  ↓ for 5 sec.

Display 1 shows	e.g. 0000	
Display 2 shows	PROGRAM EDITOR	(you are in the program editor)

Press program key  ↓

Display 1 shows	0000	
Display 2 shows	UserCod? 0000	(enter user code)

Enter the user code using arrow keys   ↓ e.g. **0001** (basic setting, adjustable in the user level, chap. 10).
Value is shown in both displays.

Automatically forward after 2 sec

Display 1 shows	e.g. 01	(program P01 selected)
Display 2 shows	--- : --- PRG.	(program can be selected)
alternating	CONTINUE X/W	(information: to 1 st program section with X/W)

Select the desired program, e.g. P01, using arrow keys   ↓ Value is shown in display1.

Press key  ↓

In the selected program P01 or P02, program sections can be selected:

Display 1 shows	e.g. 01	(actual selection of the section: S01)
Display 2 shows	P01: --- SEC.	(program section can be selected)
alternating	CONTINUE X/W	(information: set-point entry with X/W)

Select desired section, e.g. S03, using arrow keys   ↓ (omitted if section S01 shall be deleted).

Press key  ↓

Display 1 shows	e.g. 90.0 ^c	(actual temperature set-point)
Display 2 shows	S03:TEMP 90.0	(variable: temperature)
alternating	CONTINUE X/W	(information: continue with X/W)

No entry ↓

Press key  ↓

Display 1 shows	e.g. 01.00	(actual section length)
Display 2 shows	S03:TIME 01:00	(variable: section length)
alternating	CONTINUE X/W	(information: continue with X/W)

Enter set-point **Zero** for section length in hh:mm of S03 using arrow keys   ↓ Value is shown in display 2 or in both displays (display depends on maximum time setting in the user level chap. 10)

Display 1 shows	e.g. 00.00	(actual section length)
Display 2 shows	S03:TIME 00:00	(variable: section length)
alternating	DELETE SEC. X/W	(information: delete section with X/W)

Press key  ↓

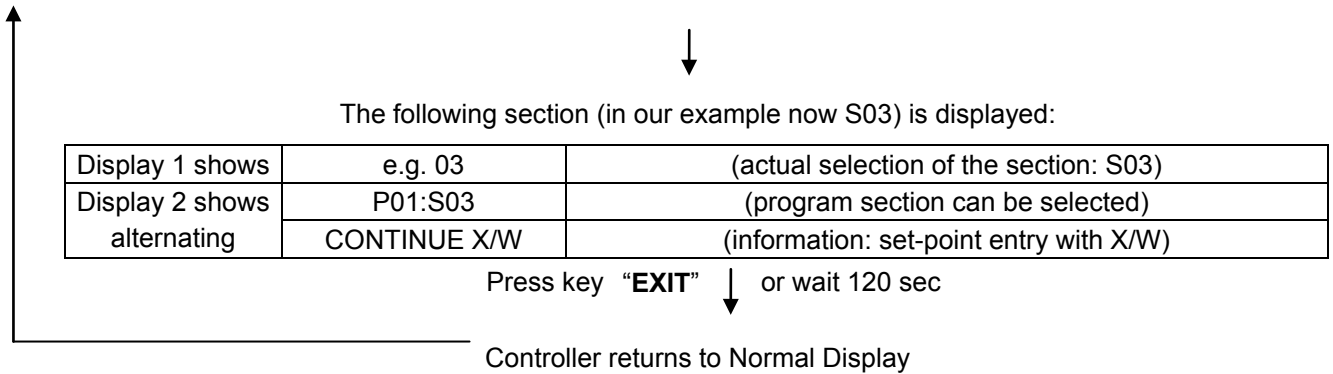



 If you delete a program section which is followed by further sections, those following move up in place of the deleted section.

In our example, section S03 has been deleted. If sections S04, S05, etc. have been programmed earlier, they will now replace the preceding sections, i.e., S04 is now called S03 etc.



Deletion leads to overwriting the section by the following one. It is therefore not possible to temporarily inactivate a program section. To enter a section later to a program, all the sections following the new one must be entered again.

9. Program start level

Before starting the program, check the set-point entered in Fixed value operation mode. After end of the program, the temperature will equilibrate to this value. This value must NOT exceed the maximum permissible drying temperature of a solvent contained in the drying material.

	 DANGER
<p>Exceeding the ignition temperature of a solvent after the program ends.</p> <p>Risk of fire and explosion.</p> <p>Danger of death.</p> <ul style="list-style-type: none"> ⊘ Set-point of Fixed value operation must NEVER reach the ignition temperature of a contained solvent. For safety reasons, always ensure that there is a safety margin (chap. 2.5). ➤ Check the set-point of Fixed value operation and if necessary adapt it acc. to the temperature setting information panel (chap. 2.5). 	

After the program ends, the temperature will equilibrate to the set-point entered in Fixed value operation mode. If the week program timer is active, another set-point (SP2) may be targeted according to programming. Too high temperatures can occur which exceed the maximum permissible drying temperature of a solvent contained in the drying material. Deactivate the week program timer before starting the program (default setting, setting in the User level, chap. 10).

	 DANGER
<p>Exceeding the ignition temperature of a solvent after the program ends.</p> <p>Risk of fire and explosion.</p> <p>Danger of death.</p> <ul style="list-style-type: none"> ➤ Deactivate the week program timer before starting the program. 	

In the first step, select a program. This is on condition that a program has been entered previously (chap. 8.2) and that program type “2 programs with 10 sections each” has been selected in the user level (chap. 10).

Then define the settings for the program course. Two parameters can be set:

- Program delay time, i.e. a defined time before a program starts. It can be entered with a precision of 1 minute, and its maximum value is 99.59 (99 h 59 min). If the value is 00.00, the program will start immediately.
- Number of program cycles, i.e. the desired number of program repeats. Values from 1 to 99 can be entered. If the program is not going to be repeated, enter the value “0”. For indefinite repeats enter the value “-1”. The program is repeated as a whole; it is not possible to repeat individual sections.

In the last step start the selected program. These steps must be carried out subsequently.



Deactivate the week program timer (factory setting, setting in the user level, chap. 10) before starting a program.

Step 1 – Program selection (only with program type “2 programs” set)

Normal Display

Press program key  ↓



Display 1 shows	e.g. 1	(actual selection of the program)
Display 2 shows	SEL.PRG.	(select program 1 or 2)

Enter program number 1 or 2 with arrow keys   ↓ Value is shown in display 1.

Next step – entry of program course settings



Press program key  ↓

Display 1 shows	e.g. 00.00	(entered delay time hh.mm)
Display 2 shows	RUN TIME	(enter delay time of program start)

Set delay time in hh.mm using arrow keys   ↓ Value is shown in display 1.

Press program key  ↓

Display 1 shows	e.g. -1	(actual selection of the number of program cycles)
Display 2 shows	REPEAT	(enter number of program cycles)

Select number of cycles -1, 0, 1 etc. using arrow keys   ↓ Value is shown in display 1.

Last step – program start

Press program key  ↓

Display 1 shows	e.g. 1	(selected program)
Display 2 shows	RUN PRG.	(Question: start selected program?)



Press program key  ↓

Display 1 shows	e.g. 25.5 °C	actual temperature value
Display 2 shows	P01:S01 00:29:39 (time running backwards)	(actual program P01, actual section S01, and remaining time of program section S01)

Program is running. The green LED (7d) lights up.

In addition to the green LED (7d) indicating a running program, the LED (7a) is lit if the heating is active, or not lit if the actual temperature equals the set-point.

	During program course the arrow keys and the “EXIT” button are not functional.
---	--

	By pressing program key  for 3 seconds, you can terminate the program course.
--	--

If you press button  during program course, the entered set-point of the actually running program section is shown for 5 sec:

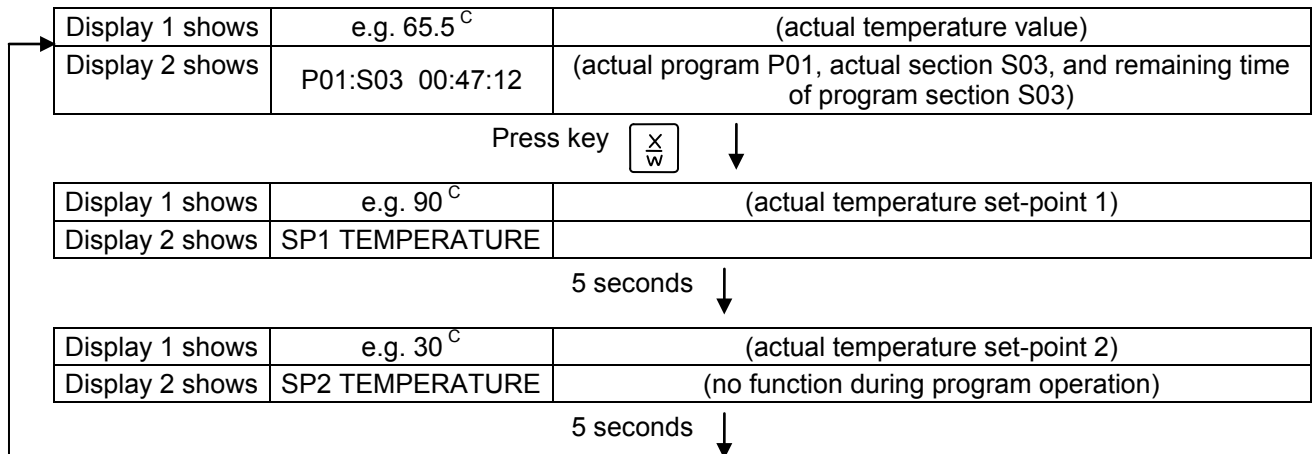

After program rundown (and, if appropriate, of the program repeats) the controller returns to fixed value operation showing Normal Display and equilibrates to the temperature value previously entered in fixed value entry mode.

10. User level

In this menu you can set the following parameters (in brackets the corresponding abbreviated information given in display 2):

- **Chamber address** (Adress)
Setting of controller address (1 to 255) for operation with the communication software APT-COM™.
- **User code** (User-cod)
Modification of the user code setting (factory setting 0001) for access to the user level and the program editor.



Keep in mind any modification of the user code. There is no access to these levels without a valid user code.

- **Decimal point position** (Decimal)
Selection if integer values or one position after the decimal point can be entered. The integer representation is shown in Display 2 (set-point entry) while the actual value in Display 1 is always shown with one decimal point.
- **Audio alert** (Buzzer)
Inactive: no audible signal (buzzer) in case of an alarm event.
Active: in case of an alarm event (see chap. 11.2) an audible signal (buzzer) will sound. It can be reset by pressing the “EXIT” button.
- **Selection of controller menu language** (Language)
German, English, or French can be selected.
- **Counter of operating hours** (Oper.hs)
Information about the number of operating hours currently reached or since the last reset (no setting, display only).
- **Max. number of operating hours** (Op.limit)
Entry of a limit number of operating hours, i.e., the maximum number of operating hours that can be run. Maximum setting: 9999. Reaching the limit has no effect.
- **Reset operating hours** (Op.back)
Reset operating hours to zero.
- **Interface protocol** (Protocol)
“**Modbus**”: The chamber interface can be used as a communication interface to connect it to a computer. This serves to control the chamber by the communication software APT-COM™. It is possible to read and write the values of all parameters.
“**Printer**”: A protocol printer for data printouts can be connected to the chamber interface. At the printer the actual temperature value is regularly protocolled with fixed formatting and with adjustable print intervals.
In both cases an interface converter RS 422 / RS 232 is used.
- **Print interval** (Prt.-Inv.)
Setting of the print interval in minutes. Function is available only if setting “Printer” has been selected in the previous menu point.
- **Display illumination** (Disp.LED)
Selection between continuous display illumination and limited illumination that will automatically go off 300 sec. after the last entry.

- **Program type selection** (PrgSelec)

Select between entry of two programs with up to 10 sections each or of one program with up to 20 sections.

	When changing from 2 programs to 1 program or vice-versa, existing programs are deleted in the program editor!
---	--

- **Maximum section duration** (Prg.Time)

The maximum length of an individual program section can be set to either 99 h 59 min or to 999 h 59 min. This setting is then valid for all program sections.

	When changing the maximum duration setting, pre-existing programs will be deleted in the program editor.
---	--

- **Set-point programming type** (Setp.sim)

Selection between “Ramp” and “Step”. With setting “Step” selected, you don’t need to program the transition section in the Program Editor.

	If you select setting “step”, the controller will equilibrate only to constant temperatures; programming ramps becomes impossible.
---	--

	A change between settings “ramp” and “step” will influence all programs. Note that significant change in time courses may arise in existing programs.
---	---

- **Tolerance limit range** (Tol.band)

Entry of a tolerance limit value in °C. If the actual value of temperature exceeds the set-point of a program section by more than the entered tolerance limit value, the program is halted (LED (7d) flashes) until the actual temperature value is again within the tolerance range

Entry of “0” means tolerance limits are off.

- **Activating or inactivating the week program timer** (Prog.Clk)

	Do not use the week program timer when using explosive substances. Make sure in this case that the week program timer has been deactivated in the User Level.
---	---

“Inactive”: The week program timer is turned off (factory setting). The corresponding setting menu (chap. 7) is not visible, nor is set-point 2 in the “Fixed value entry mode” (chap. 6).

“Active”: The week program timer is activated.

	When deactivating the week program timer, any programming made in advance will remain in memory and take effect when the week program timer is activated again.
---	---

	Deactivate the week program timer before starting a program (chap. 9).
---	--

- **Display mode** (12h/24h)

Select between 12 hours (display “AM” or “PM”) or 24 hours.

- **Date of the real time clock** (Date)

Main menu. Use the program key to access the settings of year, month, and day in the corresponding submenus.

- **Year of the real time clock** (Year)

Enter the year (2006 up to 2050)

- **Month of the real time clock** (Month)

Enter the month (1 up to 12).

- **Day of the real time clock (Day)**

Enter the day (1 up to 31).

- **Time of the real time clock (Time)**

Main menu. Use the program key to access the settings of hour and minute in the corresponding submenus.



There is no automatic switch between daylight saving time and regular time.

- **Hour of the real time clock (Hour)**

Enter the hour (0 up to 23).

- **Minute of the real time clock (Minute)**

Enter the minute (0 up to 59).

Normal Display

Display 1 shows	e.g. 39.8 ^{°C}	(actual temperature value)
Display 2 shows	e.g. 15.05.06 13:52 - -	(actual date and time, actual switching state of week program timer channel 1: Off, channel 2: Off)

Press down key  ↓ for 5 sec

Display 1 shows	e.g. 0000	
Display 2 shows	PROGRAM EDITOR	(you are in the program editor)

Press down key  ↓ for 5 sec



Display 1 shows	0000	Menu visible only if week program timer is activated.
Display 2 shows	WEEK PROG. EDITOR	(you are in the week program editor)

Press down key  ↓ for 5 sec

Display 1 shows	0000	
Display 2 shows	USER – LEVEL	(you are in the user level)

Press program key  ↓

Display 1 shows	0000	
Display 2 shows	UserCod? 0000	(enter user code, display flashes)

Enter the user code using arrow keys   ↓ e.g. **0001** (basic setting, or the valid code in case it has been previously changed in this menu). Value is shown in both displays.

Automatically forward after 2 sec

Display 1 shows	1	(actual address: 1)
Display 2 shows	Adress 1	(entry of chamber address) (actual address: 1)

Enter the chamber address (1 up to 254) using arrow keys   ↓ Address is shown in both displays.

Press key  ↓

Display 1 shows	1	(actually valid user code: 1)
Display 2 shows	User-cod 1	(change user code) (actually set: 1)

Enter a new value using arrow keys   ↓ Value is shown in both displays.

Press key  ↓

Display 1 shows	0000	(no function)
Display 2 shows	Saf.mode: Limit	(no function)

Press key  ↓

Display 1 shows	0	(no function)
Display 2 shows	Saf.setp 0	(no function)

Press key  ↓

Display 1 shows	0000	(no function)
Display 2 shows	Decimal: XXX.X	(setting of decimal point position) (actual setting: XXX.X)

Select decimal point position using arrow keys   ↓ Decimal point position XXX.X or XXXX. is shown in display 2.

Press key  ↓

Display 1 shows	0000	(no function)
Display 2 shows	Buzzer : Active	(setting of the alarm buzzer) (actual setting: „Active“)

Select between “Active” and “Inactiv” using arrow keys   ↓ Setting is shown in display 2.

Press key  ↓

Display 1 shows	0000	(no function)
Display 2 shows	Language : English	(selection of controller language) (actual setting: English)

Select between languages German, English, and French using arrow keys   ↓ Setting is shown in display 2.

Press key  ↓

Display 1 shows	e.g. 0004	(chamber operating hours)
Display 2 shows	Oper.hs 0004:28	(operating hours up to now hhhh:mm) (actually shown: 4 hs 28 min)

Press key  ↓

Display 1 shows	1000	(actual setting: 1000 hs)
Display 2 shows	Op.limit 1000:00	(maximum number of operating hours hhhh:mm (actual setting: 1000 hs)





















Set value using arrow keys   ↓ Setting is shown in both displays.



Press key  ↓

Display 1 shows	0000	(no function)
Display 2 shows	Op.back : No	(reset counter of operating hours ?) (actual setting: No)



Select between “Yes” and “No” using arrow keys   ↓ Setting is shown in display 2.

Press key  ↓

Display 1 shows	0000	(no function)
Display 2 shows	Protocol: MODBUS	(Selection of interface mode) (actual setting: Modbus)
Select between protocols "MODBUS" and "Printer" using arrow keys   ↓ Setting is shown in display 2.		
Press key  ↓		
Display 1 shows	e.g. 3	(actual setting: 3 min)
Display 2 shows	Prt-Inv. 3	(print interval) (actual setting: 3 min)
Select value between 0 and 255 minutes using arrow keys   ↓ Setting is shown in displays 1 and 2.		
Press key  ↓		
Display 1 shows	0000	
Display 2 shows	Disp.LED: No	(continuous display illumination?) (actual setting: No)
Select between "Yes" and "No" using arrow keys   ↓ Setting is shown in display 2.		
Press key  ↓		
Display 1 shows	0000	
Display 2 shows	PrgSelec: 2Prg10S	(1 program with max. 20 sections or 2 programs with max. 10 sections each?) (actual setting: 2Prg10S)
Select between "2Prg10S" and "1Prg20S" using arrow keys   ↓ Setting is shown in display 2.		
Press key  ↓		
Display 1 shows	0000	
Display 2 shows	Prg.Time: 99:59	(max. section length 99:59 or 999:59?) (actual setting: 99:59)
Select between 99:59 in hh:mm or 999:59 in hhh:mm using arrow keys   ↓ Setting is shown in display 2.		
Press key  ↓		
Display 1 shows	0000	
Display 2 shows	Setp.sim Ramp	(ramp or step?) (actual setting: ramp)
Select between Ramp and Step using arrow keys   ↓ Setting is shown in display 2.		
Press key  ↓		
Display 1 shows	0000	
Display 2 shows	Tol.band 0	(Tolerance limits in °C) (actual setting: 0)
Set value in °C using arrow keys   ↓ Setting is shown in display 2.		
Press key  ↓		
Display 1 shows	0000	
Display 2 shows	Prog.Clk Inactive	(Week program timer active or inactive?) (actual setting: Inactive)

Select between "Active" and "Inactive" using arrow keys   ↓ Setting is shown in display 2.
 Press key  ↓

Display 1 shows	0000	
Display 2 shows	12h/24h 24h	(Display mode 12 hours or 24 hours? (actual setting: 24h))



Select between 12 hours and 24 hours using arrow keys   ↓ Setting is shown in display 2.
 Press key  ↓

Display 1 shows	0000	
Display 2 shows	Date	(Main menu: Setting the date of the real time clock)



Press program key  ↓



Display 1 shows	e.g. 2006	(Actual setting: 2006)
Display 2 shows	Year 2006	(Setting the year of the real time clock)

Set year (2006 up to 2050) using arrow keys   ↓ Setting is shown in display 2.
 Press key  ↓

Display 1 shows	e.g. 5	(Actual setting: may)
Display 2 shows	Month 5	(Setting the month of the real time clock)

Set month (1 up to 12) using arrow keys   ↓ Setting is shown in display 2.
 Press key  ↓

Display 1 shows	e.g. 15	(Actual setting: 15)
Display 2 shows	Day 15	(Setting the day of the real time clock)

Set day (1 up to 31) using arrow keys   ↓ Setting is shown in display 2.
 Press key **EXIT** ↓
 Press key  ↓

Display 1 shows	0000	
Display 2 shows	Time	(Main menu: Setting the time of the real time clock)

Press program key  ↓

Display 1 shows	e.g. 13	(Actual setting: 13, i.e. 1 p.m.)
Display 2 shows	Hour 13	(Setting the hour of the real time clock)

Set hour (0 up to 23) using arrow keys   ↓ Setting is shown in display 2.
 Press key  ↓

Display 1 shows	e.g. 30	(Actual setting: 30 minutes)
Display 2 shows	Minute 30	(Setting the minute of the real time clock)

Set minute(0 up to 59) using arrow keys   ↓ Setting is shown in display 2.
 Press several times key **EXIT** ↓ or wait for 120 seconds

Controller returns to normal display.

11. Performance in case of failures

11.1 Performance after power failures

Power failure during fixed-value operation (Normal Display):

The entered parameters remain saved. After power returns, operation continues with the set parameters.

Power failure during program operation:

After the power returns, program course continues with the set-points that have been reached previously during program operation.

11.2 Alarm messages

Alarm messages, e.g. "RANGE ERROR CH1" in case of sensor rupture, are shown in Display 2 only in Normal Display.

A buzzer can be activated / deactivated in the user level (chap. 10). It can be reset by pressing the "EXIT" button. The alarm text shown in Normal Display goes off only if the cause of the alarm does not exist any longer.

12. Safety device class 2 (DIN 12880:2007)

The temperature safety device protects the vacuum drying oven, its environment and the charging material from exceeding the maximum permissible temperature.

Please observe the DGUV guidelines 213-850 on safe working in laboratories (formerly BGI/GUV-I 850-0, BGR/GUV-R 120 or ZH 1/119, issued by the employers' liability insurance association) (for Germany).

	<p>The temperature safety device only activates after the set-point has been reached once.</p>
---	--

Set the safety-device to the maximally permitted drying temperature according to the information panel "temperature setting" (chap. 2.5), to prevent exceeding the maximum drying temperature in case of a default. In the event of a fault in the temperature controller, the safety device (2) **permanently** turns off the vacuum drying oven. This status is reported visually by the indicator lamp (2a).

Check the operation of the safety device (2) by moving it slowly counter-clockwise until it is turned off. The safety device cut-off is reported visually by the indicator lamp (2a).

Then release the safety device by pressing the reset button (2b), and turn on the VDL vacuum drying oven as described previously.

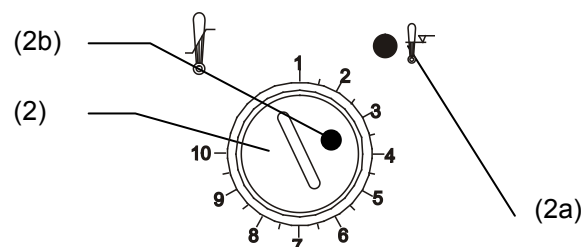

Figure 16: Temperature safety device class 2

Function:

The safety device is functionally and electrically independent of the temperature control device and turns off the chamber at all poles.

If you turn the control knob (2) to its end-stop (position 10) the safety device will protect the appliance. If you set it to a temperature a little above the set-point temperature, it will protect the charging material.

If the safety device has turned off the oven, identifiable by the red alarm lamp (2a) lighting up, proceed as follows:

- Disconnect the oven from the power supply
- Have an expert examine and rectify the cause of the fault
- Release the safety device by pressing the reset button (2b)
- Restart the oven as described in chap. 4.5.

Adjustment:

To check the response temperature of the safety device, turn on the chamber and set the desired set point on the temperature controller.

The scale division from 1 to 10 corresponds to the temperature range from 30 °C / 86°F up to 320 °C / 608°F and serves as a setting aid.

- Turn the control knob (2) of the safety device using a coin to its end-stop (position 10) (chamber protection).
- When the set point is reached, turn back the control knob (2) until its trip point (turn it counter-clockwise) is reached.
- The red alarm lamp (2a) lighting up identifies the trip point; and the reset button (2b) pops out.
- The optimum setting of the safety device is obtained by turning the knob clockwise by approx. one graduation mark on the scale.
- Push the reset button (2b) in again.

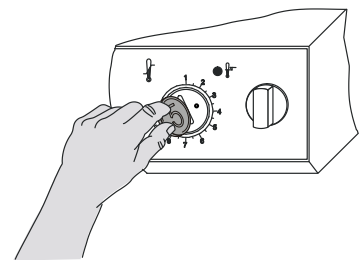

Figure 17: Setting the safety device class 2



The chamber is only active when the reset button (2b) is pushed in.

When the safety device responds, the red alarm lamp (2a) illuminates, the reset button (2b) pops out, and the oven is turned off permanently at all poles.



Check the setting regularly and adjust it following changes of the set-point or charge.

Function check:



Check the temperature safety device class 2 at appropriate intervals for its functionality. It is recommended that the authorized operating personnel should perform such a check, e.g., before starting a longer work procedure.

Example:

A substance with an ignition temperature of 160 °C shall be dried.
 The maximum allowed drying temperature is 85 °C according to the information panel "Temperature setting" at the front of the chamber (chap. 2.5). Set the temperature safety device to a temperature of 85 °C max.
 Also, the setting on the controller RD3 must not exceed this value.

According to IEC/CEI 60079-14 this chamber is not designated for the temperature classes T4, T5, and T6. Introduce only substances with an ignition temperature which is higher than 135 °C / 275°F.

This chamber is not suitable to dry substances with an ignition temperature below 135 °C / 275°F.

	 DANGER
	<p>Explosion hazard.</p> <p>Danger of death.</p> <p>∅ Do NOT introduce any substance with an ignition temperature #135 °C / 275°F into the oven.</p>

13. Reference measurements. Checking the temperature in the inner chamber

The controller display was adjusted in the factory to the temperature in the center of the usable volume (chap. 19.1). The sensor probe of the reference measuring device was connected firmly to an expansion rack positioned in the middle of the chamber.

Checking the controller display

- Conduct the reference sensor into the inner chamber through the measuring port (15). The port must be largely vacuum tight to enable a typical operation vacuum for the calibration. For a high vacuum, use a measuring access port (option). At low vacuum, a silicone plug with a hole for the sensor wire is sufficient.
- Fix the sensor to the center of an expansion rack in the middle of the useable volume with adhesive aluminum tape or thermal conductive paste to ensure sufficient thermal conductivity.
- Perform the measurement in a thermally stable condition with 3 expansion racks and empty oven.
- Equilibrating time: at least 12 hours.

Checking the spatial temperature exactitude

- Fix at least 9 sensor probes on 3 racks with adhesive aluminum tape or thermal conductive paste to ensure sufficient thermal conductivity
- The distance of the sensor probes to all inner chamber walls must be at least 10% of the corresponding inner chamber dimension (see DIN 12880).
- Perform the measurement in a thermally stable condition with 3 expansion racks and empty oven.
- Response time: at least 12 hours.

	Do NOT use the temperature probe of the reference measurement device without any contact to the expansion rack, i.e., do NOT measure vacuum values!
---	---

	In case the temperature probe is a thermo element, mount it so it is electrically insulated from the rack.
---	--

If you note an excessive divergence between the controller and reference temperatures, please contact BINDER Service to calibrate the temperature controller.

14. Commissioning the vacuum

With regard to operation, please observe the DGUV guidelines 213-850 on safe working in laboratories (formerly BGI/GUV-I 850-0, BGR/GUV-R 120 or ZH 1/119, issued by the employers' liability insurance association) (for Germany).

Starting situation: The vacuum source is connected and ready for operation.

For the vacuum module with chemical membrane pump option, see chap. 15.3.

14.1 Evacuation

- Close the aeration valve (5) and the fine dosing valve for inert gas (6).
- Turn on the vacuum pump.
- Turn the lever of the vacuum shut off valve (8) to the “ON” position (valve open).
- Monitor the internal pressure on the pressure display (3). The analog manometer displays the running evaporation respectively the end of the drying procedure. The scale of the manometer (3) refers to an ideal ambient pressure of 1013 mbar / 29.9 inHg. Tolerance: 50 mbar / 37.5 mm Hg (Torr) / 1.5 inHg (2.5% of the final scale value + reading precision).
- When the desired end vacuum is obtained, turn the VDL vacuum shutoff valve (8) to the “OFF” position (valve closed). The reached vacuum is now maintained.

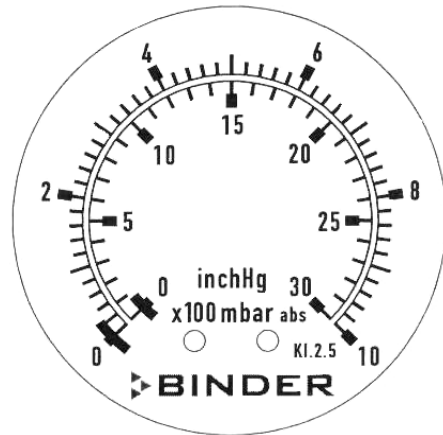

Figure 18: Manometer display



The permissible end vacuum is 10^{-2} mbar / 0.0003 inHg.



As long as there is a vacuum, never try to open the oven by force.

14.2 Breaking the vacuum (flooding with ambient air)

When the drying procedure is complete, the vacuum in the inner container is broken (flooded).



- Open aeration valve (5) and fine dosing valve for inert gas (6)
- As soon as aeration valve (5) is open, fresh air is sucked in through the fresh air connection (12). When the fine dosing valve for inert gas (6) is open, fresh air is sucked in through the inert gas connection (11).

Fresh air is introduced into the lower part of the rear panel of the inner chamber where it is evenly distributed in the inner chamber. This supply of fresh air by under-flooding prevents turbulence of pulverized drying material.

14.3 Operation with inert gas

When operating the VDL vacuum drying oven with inert gas, correctly follow the technical ventilation measures, as described in the DGUV guidelines 213-850 on safe working in laboratories (formerly BGI/GUV-I 850-0, BGR/GUV-R 120 or ZH 1/119, issued by the employers' liability insurance association) (for Germany).

During operation with inert gas, the chamber is supplied with an oxygen displacing gas (e.g. N₂). Inert gases in high concentrations are hazardous to health. They are colorless and almost odorless and therefore practically imperceptible. Inhalation of inert gases can cause drowsiness up to respiratory arrest. When the O₂ content of the air decreases below 18%, there is risk of death from lack of oxygen. Any gas that might escape has to be led out via good room ventilation or a suitable exhaust system.

	 WARNING
	<p>High concentration of inert gas. Risk of death by suffocation.</p> <ul style="list-style-type: none"> Ø Do NOT set up chambers in non-ventilated recesses. ➤ Ensure technical ventilation measures. ➤ Respect the relevant regulations for handling these gases. ➤ When decommissioning the vacuum drying oven, shut off the inert gas supply: Close valve (6).

Install a pressure reducer for inert gas operation. Set the pressure reducer to a pressure slightly above ambient pressure. Ensure that the pressure reducer will open. Do not change this setting in order to avoid perturbation inside the oven and release of big quantities of inert gas after flooding the VDL.

Following evacuation, an inert gas, e.g., nitrogen, is led into the inner chamber via the fine dosing valve for inert gas (6), until pressure compensation with the atmosphere occurs. Depending on the individual application, you can perform a second evacuation and repeat the inert gas flooding.

When the inert gas fine dosing valve is open, a maximum of approx. 0.6 m³/h gas flows into the inner chamber. The introduction of inert gas by under-flooding in the lower region of the inner chamber rear wall and the extraction at the inner chamber ceiling allow an effective inert gas flushing.

15. Options

15.1 ATEX connection kits for vacuum pumps VP4 or VP5 (option)

Connection kit for VP4 (Art. no. 8012-0621) consists of:

- Straining ring DN10/16 (3 pc.)
- Universal centering ring DN10/16 (3 pc.)
- Transition piece, adapter DN 16-10/8 (2 pc.)
- Vacuum hose 10/8, 2 m / 78.7 in
- Union nut M14 (2 pc.)
- Elbow DN 10/10

Connection kit for VP5 (Art. no. 8012-0622) consists of:

- Straining ring DN 10/16 (2 pc.)
- Straining ring DN 20/25
- Universal centering ring DN 10/16 (2 pc.)
- Outer centering ring DN 20/25
- Transition piece, adapter DN 16-10/8
- Transition piece, adapter DN 25-DN10/8 with union nut M14
- Union nut M14
- Vacuum hose 10/8, 2 m / 78.7 in
- Elbow DN 10/10

	<p>For mounting the VDL connection kits for VP4 or VP5, please refer to the mounting instructions Art. no. 7001-0152 supplied with each connection kit.</p>
---	---

15.2 Vacuum module empty (without pump) (option)



The mounting instructions Art. no. 7001-0137 supplied with the vacuum module describe how to mount the VDL vacuum drying oven onto the vacuum module and installing the suction line to the vacuum module.



Connection to a vacuum source

Connect the vacuum connection (13) (small flange DN 16) at the rear of the chamber at the top to a vacuum pump or to a domestic vacuum system via a vacuum hose or a fixed vacuum pipe.

When using a vacuum hose, we recommend using the BINDER connection kits for VP4 or VP5 (chap. 15.1). The module has an appropriate hose outlet at the back.

Figure 19: VDL 53 with the option "Vacuum module", mounted, and installed vacuum hose



CAUTION

Technical defects due to excessive negative pressure.

Danger of implosion.



Damage to the chamber.

- ∅ The end vacuum must NOT fall below the permissible level of 10^{-2} mbar / 0.0003 inHg.
- Install the pump according to the permissible end vacuum or limit the end vacuum via a vacuum controller.





Avoid the solvent accumulation in the vacuum module (option) as this would cause the vacuum module to become an explosive area (Zone 0 or 1 or 2). The VDL vacuum drying oven located on top of the module is not explosion-proof constructed in regards to its surroundings.

Inappropriate execution of the pump connection can lead to the risk of explosion.



 	 DANGER
	<p>Inappropriate pump connection.</p> <p>Risk of ignition and explosion.</p> <p>Danger of death.</p> <ul style="list-style-type: none"> ➤ It is important to observe the pump manufacturer's instructions regarding correct connection and commissioning. ➤ Observe the safety advice of chap. 1.5.

Extracted vapors or the occasionally used inert gas can endanger health and/or have a corrosive effect on the oven and pump.

	 WARNING
	<p>Release of extracted vapors.</p> <p>Danger of injury.</p> <p>Damage to the oven and pump by corrosion.</p> <ul style="list-style-type: none"> ➤ Remove the extracted vapors and, if appropriate, the inert gas from the module via a suitable conduit into e.g., a fume extractor facility. ➤ Directly connect the conduit to the corresponding pump outlets.

	<p>Confirm that the vacuum source is designed for a gas inlet temperature corresponding to the used drying temperature, or take appropriate measures to cool down the extracted vapor before its entry into the vacuum source.</p>
---	--

A gas inlet temperature of 40 °C / 104°F maximum must NOT be exceeded. If the gas inlet temperature is too high and then becomes even warmer by compression in the pump, the resulting temperature (of the gas-solvent mixture inside the pump) could exceed the solvent's temperature class and ignition temperature.

	 DANGER
	<p>Exceeding the gas inlet temperature.</p> <p>Exceeding the ignition temperature of the solvent.</p> <p>Risk of ignition and explosion.</p> <p>Damage to the vacuum pump.</p> <p>Danger of death.</p> <ul style="list-style-type: none"> ⊘ Do NOT exceed a set-point temperature of 40 °C / 104°F. ➤ With set-point temperature > 40 °C / 104°F, take appropriate measures to cool down the extracted vapor before its entry in the vacuum pump.

15.3 Vacuum module with chemical membrane pump VP4 or VP5 (option)



The mounting instructions Art. no. 7001-0137 supplied with the vacuum module describe how to mount the VDL vacuum drying oven onto the vacuum module and installing the suction line into the vacuum module.

The VP4 or VP5 chemical membrane pump is located in a separate transport packaging. Both pump types are delivered as complete pump stations with a separator and an exhaust waste vapor condenser.



Figure 20: VDL 53 with option vacuum module with pump

(13) Vacuum connection



Avoid the solvent accumulation in the vacuum module (option) as this would cause the vacuum module to become an explosive area (Zone 0 or 1 or 2). The VDL vacuum drying oven located on top of the module is not explosion-proof constructed in regards to its surroundings.

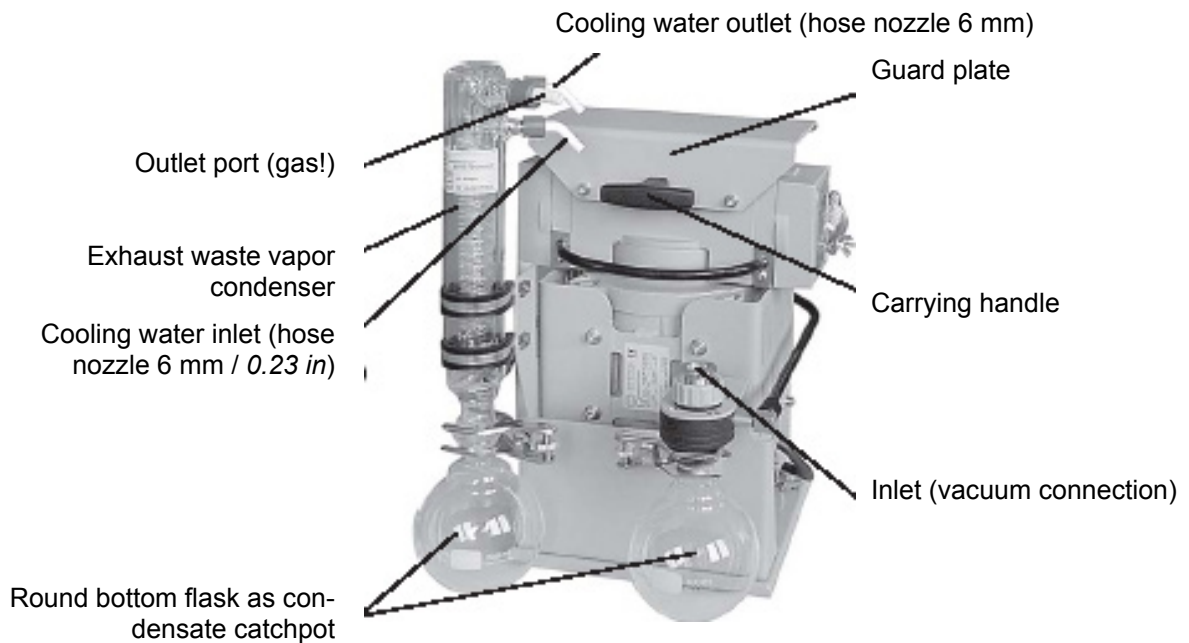

Figure 21: Vacuum pump VP4 (MZ2C EX)

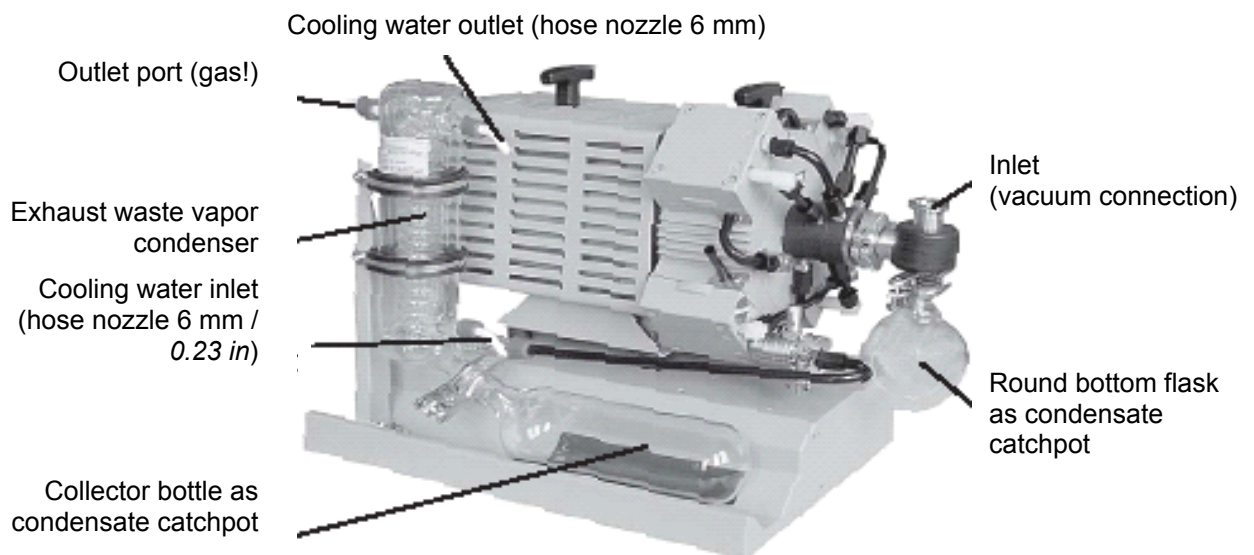

Figure 22: Vacuum pump VP5 (MZ4C EX)



Defining the zone of the installation site of the vacuum pump (guideline 1999/92/EC)

If the pump module is defined as Zone 1, the operating chamber of the vacuum pump must be swept with inert gas. A flow of at least 1 liter per minute (without pressure) is needed. For Zone 2 or without any zone sweeping with inert gas is not needed. In addition to sweeping with inert gas, in case of condensing media, you can connect a gas ballast in order to avoid condensation.



Installation of the supplied vacuum pump

- The vacuum drying oven is mounted onto the vacuum module as described in the mounting instructions Art. no. 7001-0137.
- The suction line is installed to the vacuum module as described in the mounting instructions Art. no. 7001-0137.
- When the pump is removed from the original packaging, place it in the vacuum module.
- Connect the pre-installed suction line to the vacuum pump inlet at the suction-side small flange connection located at the top of the condensate flask.
- Connect a conduit that is suitable for removing the extracted vapors from the module, onto the pressure-side connection of the vacuum pump (hose olive on the top-back of the emission condenser).
- Guide the end of the conduit into an exhaust air system, which is explosion-proof constructed in consideration of any possible residual solvent contents. The operator must check if an explosive atmosphere may be present at the pump exit or at the exhaust waste vapor condenser. For this purpose, use a calculation of the solvent's partial pressure at the set-up coolant temperature of the exhaust waste vapor condenser and compare it to the explosion limits of the pumped solvent. The exhaust solvent concentration should be minimized by selecting the most appropriate condensation temperature for the solvent at the refrigeration plant that can be connected to the exhaust waste vapor condenser. The pumped-out gases at the pump exit or the exhaust waste vapor condenser must be removed in a controlled manner and according to applicable security regulations. If there is any possibility that an explosive mixture could still exist, the exhaust must be removed through antistatic conduits and disposed of according to the valid regulations of explosion protection.
- The electrical connection is established at the pump's connector box. This must be carried out according to the original user manual of the pump manufacturer and to EN 60079-14. In addition, the zone that has been defined by the user for the installation site of the pump must be correctly observed. Equipotential bonding between the pump housing and the housing of the VDL vacuum drying oven must be assured by the connected equipment grounding conductors of both units.

Inappropriate execution of the pump connection can lead to the risk of explosion.

 	 DANGER
	<p>Inappropriate pump connection.</p> <p>Risk of ignition and explosion.</p> <p>Danger of death.</p> <ul style="list-style-type: none"> ➤ It is obligatory to follow the instructions of the pump manufacturer regarding correct connection and commissioning. ➤ Observe the safety advice as in chap. 1.5.

Extracted vapors or the occasionally used inert gas can endanger health. They can also have a corrosive effect on the oven and pump.



	 WARNING
	<p>Release of extracted vapors.</p> <p>Danger of injury.</p> <p>Damage to oven and pump by corrosion.</p> <ul style="list-style-type: none"> ➤ Remove the extracted vapors and, if appropriate, the inert gas from the module via a suitable conduit into e.g., a fume extractor facility. ➤ Directly connect the conduit to the corresponding pump outlets.

	<p>You can connect a laboratory cooling system to the emission condenser of the vacuum pumps VP4 or VP5.</p>
---	--

	<p>To operate the chemical membrane pumps VP4 (MZ2C EX) or VP5 (MD4C EX), please refer to the enclosed pump manufacturer's operating manual.</p>
---	--

	<p>Confirm that the vacuum source is designed for a gas inlet temperature corresponding to the used drying temperature, or take appropriate measures to cool down the extracted vapor before its entry into the vacuum source.</p>
---	--

The ATEX Directive 2014/34/EU compliant vacuum pumps offered by BINDER are designed for a gas inlet temperature of 40 °C / 104°F max. Do NOT exceed this temperature. If the gas inlet temperature is too high and then becomes even warmer by compression in the pump, the resulting temperature (of the gas-solvent mixture inside the pump) could exceed the solvent's temperature class and ignition temperature.

	 DANGER
	<p>Exceeding the gas inlet temperature.</p> <p>Exceeding the ignition temperature of the solvent.</p> <p>Risk of ignition and explosion.</p> <p>Damage to the vacuum pump.</p> <p>Danger of death.</p> <ul style="list-style-type: none"> ⊘ Do NOT exceed a set-point temperature of 40 °C / 104°F. ➤ With set-point temperature > 40 °C / 104°F, take appropriate measures to cool down the extracted vapor before its entry into the vacuum pump.

The maximum permissible ambient temperature of the vacuum pumps delivered by BINDER is 40 °C / 104°F.

15.4 Additional measuring channel for digital object temperature display with flexible Pt 100 temperature sensor (option)

The object temperature display permits recording the object temperature directly on or in the drying material. The object temperature is measured via a flexible Pt100 sensor inside the inner chamber. The sensor needs to be in thermally conducting contact with the charging material. It can be plunged into humid charging material up to the length of its protecting tube.

The object temperature is indicated on Display 2 of the RD3 controller.

Display 1 shows	e.g. 24.6 °C	(actual temperature value)
Display 2 shows	24.4 15:41	(actual object temperature in °C, actual time)



Figure 23:
Standard Display without the
object temperature display option



Figure 24:
Display with the
object temperature display option

The object temperature data is put out combined with the temperature data of the controller to the RS 422 interface as a second measuring channel. This permits recording by the BINDER documentation software APT-COM™ DataControlSystem (option, chap. 15.6).

Assembly and connection of the object temperature recording

- Insert the Pt 100 temperature sensor from the rear through the measuring connection (15) into the inner chamber.
- The 3 contacts of the Pt 100 sensor are conducted outside via a measuring access port. From there, establish the connection to the DIN socket (14) at the top of the rear panel of the chamber marked "Pt100". For reasons of explosion protection, this electrical connection to the inner chamber is conducted via a triple internal safety barrier with a conducting-state voltage of 1.6 Volt maximum against ground.

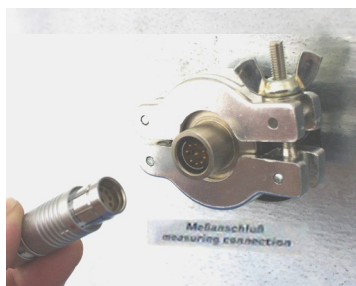

Figure 25:
Measuring connection (15)
with measuring access port
Plug for connection cable to
DIN socket "Pt 100"



Figure 26:
Measuring current port with universal
eccentric ring and locking ring DN 16,
with flexible Pt 100 temperature sensor

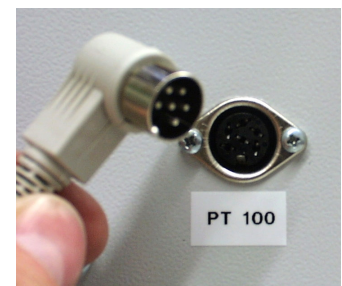

Figure 27:
Pt100 connection (14) at
the rear of the chamber

Technical data of the Pt 100 sensor:

- Three-wire technique
- Class B (EN 60751)
- Temperature range up to 300 °C / 572°F
- Stainless steel protective tube, length 45 mm / 1.77 in, stainless steel material no. 1.4501



If the oven is charged to full capacity, depending on the load, deviations from the specified heating up times may occur.

15.5 Measuring access port vacuum 9 poles (option)

The measuring access port allows creating electrical connections for low voltages or sensors between the exterior and interior of the VDL vacuum drying oven. A 9 poles plug for the outside is included.





Figure 28: Measuring connection (15) with measuring access port and supplied plug

Connections at the measuring access port

- At the inner side of the measuring access port you can solder up to 9 cables. The inside connections must be insulated against each other and against ground. Use 300 °C / 572°F solder.
- The 9 contacts are conducted outside via the measuring access port. You can use them to connect a device via the supplied plug.

Maximum load capacity of the switching contacts: 42 V AC/DC - 2A

	 DANGER
	<p>Electrical hazard.</p> <p>Danger of death.</p> <p>Damage to switching contacts and connection socket.</p> <ul style="list-style-type: none"> ⊘ Do NOT exceed the maximum switching load of 42 AC/DC – 2 Amp. ⊘ Do NOT connect any devices with a higher load capacity. ➤ Insulate the inside connections against each other and against ground. Use 300 °C / 572°F solder.

15.6 Communication software APT-COM™ 3 DataControlSystem (option)

The chamber is regularly equipped with a serial interface RS 422 (9) that can connect the BINDER communication software APT-COM™ 3 DataControlSystem. The actual temperature value is given at adjustable intervals. Programming can be performed graphically via PC. Up to 30 chambers with RS 422 interface can be cross-linked. For further information, refer to the operating manual of the BINDER communication software APT-COM™ 3.



	Confirm that the interface mode is correctly set to “Modbus” in the user level (chap. 10).
---	--

Pin allocation of the RS 422 interface (9):

pin 2:	RxD (+)
pin 3:	TxD (+)
pin 4:	RxD (-)
pin 5:	TxD (-)
pin 7:	GND

16. Maintenance, cleaning, and service

16.1 Maintenance intervals, service

 	 DANGER
	<p>Electrical hazard. Danger of death.</p> <ul style="list-style-type: none"> ⊘ The chamber must NOT become wet during operation or maintenance work. ⊘ Do NOT remove the rear panel of the chamber. ➤ Before conducting maintenance work, turn off the chamber at the main power switch and disconnect the power plug. ➤ Ensure all maintenance work is conducted by licensed electricians or experts authorized by BINDER.

Ensure regular maintenance work is performed at least once a year.

	The warranty becomes void if maintenance work is conducted by non-authorized personnel.
---	---



	Replace the door gasket only when cold. Otherwise, the door gasket may become damaged.
--	--

We recommend taking out a maintenance agreement. Please consult BINDER Service:

BINDER telephone hotline:	+49 (0) 7462 2005 555
BINDER fax hotline:	+49 (0) 7462 2005 93555
BINDER e-mail hotline:	service@binder-world.com
BINDER service hotline USA:	+1 866 885 9794 or +1 631 224 4340 x3 (toll-free in the USA)
BINDER service hotline Asia Pacific:	+852 390 705 04 or +852 390 705 03
BINDER service hotline Russia and CIS	+7 495 988 15 16
BINDER Internet website	http://www.binder-world.com
BINDER address	BINDER GmbH, post office box 102, 78502 Tuttlingen, Germany



International customers, please contact your local BINDER distributor.

The condensate separator is equipped with a manual condensate outlet. When condensate has accumulated in the condensate separator, you can let it off by opening the discharging screw at the bottom. With connected supply pressure for sweeping the area for electrical equipment, condensate may spout.

	 CAUTION
	<p>Opening the discharging screw with connected supply pressure for sweeping the area for electrical equipment. Danger by spouting condensate.</p> <ul style="list-style-type: none"> ➤ Wear eye protectors when the supply pressure for sweeping the area for electrical equipment is connected.

16.2 Cleaning and decontamination

Clean the chamber after each use to avoid potential corrosion damage by ingredients of the charging material.

	 DANGER
	<p>Electrical hazard.</p> <p>Danger of death.</p> <ul style="list-style-type: none"> Ø Do NOT spill water or cleaning agents over the inner and outer surfaces. ➤ Before cleaning, turn off the chamber at the main power switch and disconnect the power plug. ➤ Completely dry the appliance before turning it on again.

16.2.1 Cleaning

Disconnect the oven from the power supply before cleaning. Disconnect the power plug.

	The interior of the chamber must be kept clean. Thoroughly remove any residues of the charging material.
---	--

Wipe the surfaces with a moistened towel. In addition, you can use the following cleaning agents:

Exterior surfaces, inner chamber, door gaskets	Standard commercial cleaning detergents free from acid or halides. Alcohol-based solutions. We recommend using the neutral cleaning agent Art. No. 1002-0016.
Expansion racks, rack holders	Standard commercial cleaning detergents free from acid or halides, no salt solution or chlorinated solvents. We recommend using the neutral cleaning agent Art. No. 1002-0016.
Instrument panel	Standard commercial cleaning detergents free from acid or halides. We recommend using the neutral cleaning agent Art. No. 1002-0016.
Filter of compressed air supply	If necessary, use compressed air
Zinc coated hinge parts rear chamber wall	Standard commercial cleaning detergents free from acid or halides. Do NOT use a neutral cleaning agent on zinc coated surfaces.

Do not use cleaning agents that may cause a hazard due to reaction with components of the device or the charging material. If there is doubt regarding the suitability of cleaning products, please contact BINDER service.

	<p>We recommend using the neutral cleaning agent Art. No. Art. Nr. 1002-0016 for a thorough cleaning.</p> <p>Any corrosive damage that may arise following use of other cleaning agents is excluded from liability by BINDER GmbH.</p> <p>Any corrosive damage caused by a lack of cleaning, is excluded from liability by BINDER GmbH.</p>
---	---

	CAUTION
	<p>Danger of corrosion.</p> <p>Damage to the chamber.</p> <ul style="list-style-type: none"> ∅ Do NOT use acidic or chlorine cleaning detergents. ∅ Do NOT use a neutral cleaning agent on other kind of surfaces e.g., the zinc coated hinge parts or the rear chamber wall.

	<p>For surface protection, perform cleaning as quickly as possible.</p> <p>After cleaning completely remove cleaning agents from the surfaces with a moistened towel. Let the chamber dry.</p>
---	--







	<p>Soapsuds may contain chlorides and must therefore NOT be used for cleaning.</p>
---	--

	<p>With every cleaning method, always use adequate personal safety controls.</p>
---	--

Following cleaning, leave the chamber door open or remove the access port plugs.

	<p>The neutral cleaning agent may cause health problems in contact with skin and if ingested. Follow the operating instructions and safety hints labeled on the bottle of the neutral cleaning agent.</p>
--	---

Recommended precautions: To protect the eyes use sealed protective goggles. Suitable protective gloves with full contact: butyl or nitrile rubber, penetration time >480 minutes.

    	 CAUTION
	<p>Contact with skin, ingestion.</p> <p>Skin and eye damage due to chemical burns.</p> <ul style="list-style-type: none"> ∅ Do not ingest. Keep away from food and beverages. ∅ Do NOT empty into drains. ➤ Wear protective gloves and goggles. ➤ Avoid skin contact.

16.2.2 Decontamination

The operator must ensure that proper decontamination is performed in case a contamination of the chamber by hazardous substances has occurred.

Disconnect the chamber from the power supply prior to chemical decontamination. Disconnect the power plug.

Do not use decontamination agents that may cause a hazard due to reaction with components of the device or the charging material. If there is doubt regarding the suitability of cleaning products, please contact BINDER service.

You can use the following disinfectants:

Inner chamber	Standard commercial surface disinfectants free from acid or halides. Alcohol based solutions. We recommend using the disinfectant spray Art. No. 1002-0022.
---------------	---

	For chemical disinfection, we recommend using the disinfectant spray Art. No. 1002-0022. Any corrosive damage that may arise following use of other disinfectants is excluded from liability by BINDER GmbH.
---	---

	With every decontamination method, always use adequate personal safety controls.
---	--



In case of contamination of the interior by biologically or chemically hazardous material, there are two possible procedures depending on the type of contamination and charging material.

- (1) Vacuum drying ovens VDL can be sterilized at 190 °C / 374 °F for at least 30 minutes. All inflammable goods must be removed from the interior before.
- (2) Remove the vacuum expansion racks and removable rack holders and spray the inner chamber with an appropriate disinfectant.

If desired you can sterilize the vacuum expansion racks and removable rack holders in a sterilizer or autoclave. Before start-up, the chamber must be absolutely dry and ventilated, as explosive gases may form during the decontamination process.

	In case of eye contact, the disinfectant spray may cause eye damage due to chemical burns. Follow the operating instructions and safety hints labeled on the bottle of the disinfectant spray.
---	--

Recommended precautions: To protect the eyes use sealed protective goggles.

	<div style="background-color: yellow; text-align: center; padding: 5px;"> CAUTION</div> <p>Eye contact. Eye damage due to chemical burns.</p> <ul style="list-style-type: none"> ⊘ Do NOT empty into drains. ➤ Wear protective goggles.
---	---

	After using the disinfectant spray, allow the chamber to dry thoroughly, and aerate it sufficiently.
---	--

16.3 Sending the chamber back to BINDER GmbH

If you return a BINDER product to us for repair or any other reason, we will only accept the product upon presentation of an authorization number (RMA number) that has previously been issued to you. An authorization number will be issued after receiving your complaint either in writing or by telephone **prior** to your sending the BINDER product back to us. The authorization number will be issued following receipt of the information below:

- BINDER product type and serial number
- Date of purchase
- Name and address of the dealer from which you bought the BINDER product
- Exact description of the defect or fault
- Complete address, contact person and availability of that person
- Exact location of the BINDER product in your facility
- A contamination clearance certificate (chap. 22) must be faxed in advance

The authorization number must be applied to the packaging in such a way that it can be easily recognized or be recorded clearly in the delivery documents.

	For security reasons we cannot accept a chamber delivery if it does not carry an authorization number.
---	--

Return address: BINDER GmbH Gänsäcker 16
Abteilung Service 78502 Tuttlingen, Germany

17. Disposal

17.1 Disposal of the transport packing

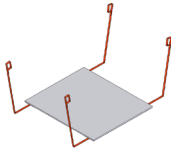
Packing element	Material	Disposal
Straps to fix packing on pallet	Plastic	Plastic recycling
Wooden transport box (option) with metal screws	Non-wood (compressed match-wood, IPPC standard)	Wood recycling
	Metal	Metal recycling
Pallet with foamed plastic stuffing	Solid wood (IPPC standard)	Wood recycling
	PE foam	Plastic recycling
Transport box with metal clamps	Cardboard	Paper recycling
	Metal	Metal recycling
Removal aid 	Cardboard	Paper recycling
	Plastic	Plastic recycling
Edge protection	Styropor® or PE foam	Plastic recycling
Protection of doors	PE foam	Plastic recycling
Bag for operating manual	PE foil	Plastic recycling
Insulating air cushion foil (packing of optional accessories)	PE foil	Plastic recycling

If recycling is not possible, all packing parts can also be disposed of with normal waste.

17.2 Decommissioning



- Turn off the key switch (1) (position 0).



When turning off the key switch (1), the stored parameters remain saved.

- Close the fine dosing valve (6) for inert gas supply.

Through the open inert gas connection, inert gas can enter the vacuum drying oven and escape into the ambient air.

	 WARNING
	<p>High concentration of inert gas. Risk of death by suffocation.</p> <ul style="list-style-type: none"> ➤ Respect the relevant regulations for handling these gases. ➤ When decommissioning the VDL vacuum drying oven, turn off the inert gas supply: close valve (6).

- Turn off the vacuum pump. Break the vacuum as described in chap. 14.2
- Disconnect the oven from the power supply. Pull the power plug.
- Remove the vacuum connection (chap. 4.2).
- Remove the inert gas connection and the pressure reducer (chap. 4.3).

Temporal decommissioning: See indications for appropriate storage, chap. 3.3.

Final decommissioning: Dispose of the chamber as described in chap. 17.3 to 17.5.

17.3 Disposal of the chamber in the Federal Republic of Germany

According to Annex I of Directive 2012/19/EU of the European Parliament and of the Council on waste electrical and electronic equipment (WEEE), BINDER devices are classified as “monitoring and control instruments” (category 9) only intended for professional use“. They must not be disposed of at public collecting points.

The chambers bear the symbol for the marking of electrical and electronic equipment manufactured / placed on the market in the EU after 13 August 2005 and be disposed of in separate collection according to Directive 2012/19/EU on waste electrical and electronic equipment (WEEE) and German national law for electrical and electronic equipment (Elektro- und Elektronikgerätegesetz, ElektroG). WEEE marking: crossed-out wheeled bin with solid bar under. A significant part of the materials must be recycled in order to protect the environment.

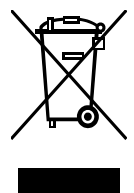



At the end of the device's service life, have the chamber disposed of according to the German national law for electrical and electronic equipment (Elektro- und Elektronikgerätegesetz, ElektroG from 20 October 2015, BGBl. I p. 1739) or contact BINDER service who will organize taking back and disposal of the chamber according to the German national law for electrical and electronic equipment (Elektro- und Elektronikgerätegesetz, ElektroG from 20 October 2015, BGBl. I p. 1739).

	CAUTION
	<p>Violation against existing law.</p> <ul style="list-style-type: none"> ∅ Do NOT dispose of BINDER devices at public collecting points. ➤ Have the device disposed of professionally at a recycling company which is certified according to the German national law for electrical and electronic equipment (Elektro- und Elektronikgerätegesetz, ElektroG from 20 October 2015, BGBl. I p. 1739). <li style="text-align: center;"><i>or</i> ➤ Instruct BINDER Service to dispose of the device. The general terms of payment and delivery of BINDER GmbH apply, which were valid at the time of purchasing the chamber.

Certified companies disassemble waste (used) BINDER equipment in primary substances for recycling according to Directive 2012/19/EU. The devices must be free from toxic, infectious or radioactive substances in order to eliminate any health hazards to the employees of the recycling companies.

	<p>Prior to handing the chamber over to a recycling company, it is the user's responsibility that it is free from toxic, infectious or radioactive substances.</p> <ul style="list-style-type: none"> • Prior to disposal, clean all introduced or residual toxic substances from the chamber. • Prior to disposal, disinfect the chamber from all sources of infection. Be aware that sources of infection may also be located outside the inner chamber. • If you cannot safely remove all toxic substances and sources of infection from the chamber, dispose of it as "special" waste according to national law. • Fill out the contamination clearance certificate (chap. 22) and enclose it with the chamber.
---	---

 	WARNING
	<p>Contamination of the device with toxic, infectious or radioactive substances.</p> <p>Danger of intoxication.</p> <p>Danger of infection.</p> <ul style="list-style-type: none"> ∅ NEVER take a chamber contaminated with toxic substances or sources of infection for recycling according to Directive 2012/19/EU. ➤ Prior to disposal, remove all toxic substances and sources of infection from the chamber. ➤ Dispose of a chamber from which all toxic substances or sources of infection cannot be safely removed as "special" waste according to national law.

17.4 Disposal of the chamber in the member states of the EC except for the Federal Republic of Germany

According to Annex I of Directive 2012/19/EU of the European Parliament and of the Council on waste electrical and electronic equipment (WEEE), BINDER devices are classified as "monitoring and control instruments" (category 9) only intended for professional use". They must not be disposed of at public collecting points.

The chambers bear the symbol for the marking of electrical and electronic equipment manufactured / placed on the market in the EC after 13 August 2005 and be disposed of in separate collection according to the Directive 2012/19/EU on waste electrical and electronic equipment (WEEE). WEEE marking: crossed-out wheeled bin with solid bar under.

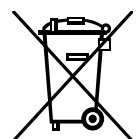



At the end of the device's service life, notify the distributor who sold you the device, who will take back and dispose of the chamber according to the Directive 2012/19/EU on waste electrical and electronic equipment (WEEE).



	CAUTION
	<p>Violation against existing law.</p> <ul style="list-style-type: none"> ∅ Do NOT dispose of BINDER devices at public collecting points. ➤ Have the device disposed of professionally at a recycling company that is certified according to conversion of the Directive 2012/19/EU into national law. <i>or</i> ➤ Instruct the distributor who sold you the device to dispose of it. The agreements apply that were agreed with the distributor when purchasing the chamber (e.g. his general terms of payment and delivery). ➤ If your distributor is not able to take back and dispose of the chamber, please contact BINDER service.

Certified companies disassemble waste (used) BINDER equipment in primary substances for recycling according to Directive 2012/19/EU. The devices must be free from toxic, infectious or radioactive substances in order to eliminate any health hazards to the employees of the recycling companies.

	<p>Prior to handing the chamber over to a recycling company, it is the user's responsibility that it is free from toxic, infectious or radioactive substances.</p> <ul style="list-style-type: none"> • Prior to disposal, clean all introduced or residual toxic substances from the chamber. • Prior to disposal, disinfect the chamber from all sources of infection. Be aware that sources of infection may also be located outside the inner chamber. • If you cannot safely remove all sources of infection and toxic substances from the chamber, dispose of it as "special" waste according to national law. • Fill out the contamination clearance certificate (chap. 22) and enclose it with the chamber.
---	---

	 WARNING
	<p>Contamination of the device with toxic, infectious or radioactive substances.</p> <p>Danger of intoxication.</p> <p>Danger of infection.</p> <ul style="list-style-type: none"> ∅ NEVER take a chamber contaminated with toxic substances or sources of infection for recycling according to Directive 2012/19/EU. ➤ Prior to disposal, remove all toxic substances and sources of infection from the chamber. ➤ A chamber from which all toxic substances or sources of infection cannot be safely removed must be considered as "special" waste according to national law. Dispose of it accordingly.

17.5 Disposal of the chamber in non-member states of the EC

 	CAUTION
	<p>Alteration of the environment.</p> <ul style="list-style-type: none"> ➤ For final decommissioning and disposal of the vacuum drying oven, please contact BINDER Service. ➤ Follow the statutory regulations for appropriate, environmentally friendly disposal.

The main board of the vacuum drying oven includes a lithium cell. Please dispose of it according to national regulations.

18. Troubleshooting

Fault description	Possible cause	Required measures
General		
Chamber permanently turned off.	No power supply.	Check connection to power supply.
	Wrong voltage.	Check power supply for voltage of 115V or 230V.
	Oven not connected to compressed air supply.	Connect the oven to the compressed air supply before start-up.
	Chamber fuse has responded.	Check chamber fuse.
	Safety device has turned off the oven.	Allow the oven to cool down and press the "RESET" button. Check temperature set-point and setting of safety device (chap. 12). If appropriate, select suitable limit value.
	Safety device defective. Controller defective.	Contact BINDER Service.
Heating		
Chamber doesn't heat up. LED (7a) "Heating active" lit. Pilot light (4) "No heating release" lit.	Pressure > 125 ± 25 mbar / 3.69 ± 0.74 inHg.	A vacuum of 125 ± 25 mbar / 3.69 ± 0.74 inHg.) or below is needed for heating release.
	Chamber door not properly closed.	Completely close chamber door.
	Door gasket defective.	Replace door gasket.
Chamber doesn't heat up. LED (7a) "Heating active" lit. Pilot light (4) "No heating release" not lit.	Heating element defective.	Contact BINDER Service.
	Semiconductor relay defective.	
Chamber doesn't heat up. LED (7a) "Heating active" not lit.	Safety device has turned off the oven.	Allow the oven to cool down and press down the "RESET" button. Check temperature set-point and setting of safety device (chap. 12). If appropriate, select suitable limit value.
	Controller defective	Contact BINDER Service
Set-point temperature is not reached after specified time.	Controller not adjusted.	Calibrate and adjust controller.

Fault description	Possible cause	Required measures
Heating (continued)		
Chamber heating permanently, set-point not held.	Controller defective.	Contact BINDER Service.
	Pt 100 sensor defective.	
	Semiconductor relay defective	
	Controller not adjusted.	Calibrate and adjust controller.
Deviations from the indicated heating-up times.	Oven fully loaded.	Charge the oven less or consider longer heating-up times.
Deviations from the temperature set-point in equilibrated state.	Invalid calibration	Use the delivered expansion racks only. Do NOT change between aluminum and stainless steel racks
Wrong temperature value measured during calibration.	Reference temperature sensor has insufficient contact to expansion rack.	Fix the reference temperature sensor with thermal conductive paste or adhesive aluminum tape.
	Leakage current when using a thermo element not electrically insulated	Mount a thermo element electrically insulated from the rack.
Vacuum		
Vacuum not held.	Door gasket defective.	Replace door gasket,
	Safety glass panel defective.	Replace safety glass panel.
	Gaskets of small flange connections (universal eccentric ring) defective.	Replace gaskets of small flange connections.
	Inner tube connection leaky.	Contact BINDER Service.
Controller		
No indication on the controller display after turning on the oven.	Oven not connected to compressed air supply.	Connect the oven to the compressed air supply before start-up.
Program doesn't run correctly after it is started.	Pressure > 125 ± 25 mbar / 3.69 ± 0.74 inHg).	A vacuum of 125 ± 25 mbar / 3.69 ± 0.74 inHg) or below is needed for heating release. Only then start the program.
Program duration longer than programmed.	Inappropriate tolerances have been programmed.	For rapid transition phases, do NOT program tolerance limits in order to permit maximum heating speed.
Program stops one section too early.	Program line is incomplete.	When programming, define the end value of the desired cycle by adding an additional section with a section time of at least one minute (with setting "ramp").
Programs have been deleted.	Change from 2 programs to 1 program or vice-versa	When changing, ensure that the programs are no longer needed.
The controller returns to Normal Display from any level.	No button was pressed for more than 120 sec.	Repeat entries, enter the values rapidly.
Message RANGE ERROR CH1 in Normal Display in Display 2	Sensor rupture between sensor and controller	Contact BINDER Service.
Ramp temperature transitions are only realized as steps.	Set-point programming type set to "Step" in the User level (chap. 10).	Set the set-point programming type to setting "Ramp" in the User level (chap. 10).



Only qualified service personnel authorized by BINDER must perform repair. Repaired chambers must comply with the BINDER quality standards.

19. Technical description

19.1 Factory calibration and adjustment

This chamber was calibrated and adjusted in the factory. Calibration and adjustment were performed using standardized test instructions, according to the QM DIN EN ISO 9001 system applied by BINDER (certified since December 1996 by TÜV CERT). All test equipment used is subject to the administration of measurement and test equipment that is also a constituent part of the BINDER QM DIN EN ISO 9001 systems. They are controlled and calibrated to a DKD-Standard at regular intervals.

Factory adjustment was done in the center of the usable volume and under vacuum conditions. The sensor is fixed in the middle of the expansion rack in a way ensuring good thermal conductivity (heat conduction). Measuring is performed in equilibrated state.

	CAUTION		
	<p>Invalid calibration.</p> <ul style="list-style-type: none"> ⊘ Do NOT change between aluminum and stainless steel racks. ➤ Use the delivered expansion racks only. 		

19.2 Technical data

Chamber size		23	53	115
External dimensions				
Vacuum oven				
Width, net	mm / inch	515 / 20.28	634 / 24.96	740 / 29.13
Height, gross (including feet)	mm / inch	655 / 25.79	775 / 30.51	900 / 35.43
Depth, net	mm / inch	500 / 19.69	550 / 21.65	670 / 26.38
Depth, gross (including door handle, connections)	mm / inch	600 / 23.62	650 / 25.59	770 / 30.31
Vacuum module (option)				
Width, net	mm / inch	515 / 20.28	634 / 24.96	740 / 29.13
Height, net	mm / inch	624 / 24.57	624 / 24.57	622 / 24.49
Depth, net	mm / inch	500 / 19.69	550 / 21.65	670 / 26.38
Depth, gross (including door handle, connections)	mm / inch	600 / 23.62	650 / 25.59	770 / 30.31
Chamber with optional vacuum module				
Width, net	mm / inch	515 / 20.28	634 / 24.96	740 / 29.13
Height, net	mm / inch	1279 / 50.35	1400 / 55.12	1522 / 59.92
Depth, net	mm / inch	500 / 19.69	550 / 21.65	670 / 26.38
Depth, gross (including door handle, connections)	mm / inch	600 / 23.62	650 / 25.59	770 / 30.31
Wall clearances				
Wall clearance, rear (minimum)	mm / inch	100 / 3.94	100 / 3.94	100 / 3.94
Wall clearance, side (minimum)	mm / inch	135 / 5.31	135 / 5.31	135 / 5.31
Internal dimensions				
Width	mm / inch	285 / 11.22	400 / 15.75	506 / 19.92
Height	mm / inch	285 / 11.22	400 / 15.75	506 / 19.92
Depth	mm / inch	295 / 11.61	340 / 13.38	460 / 18.11
Interior volume	l / cu.ft.	23 / 0.8	53 / 1.9	115 / 4.1

Chamber size		23	53	115
Racks				
Number of expansion racks (aluminum), series		2	2	2
Number of expansion racks (aluminum), max.		4	5	6
Distance between the racks	mm / inch	53 / 2.09	62 / 2.44	68 / 2.68
Usable space per rack (width x depth)	mm / inch	234 x 280 / 9.21 x 11.02	349 x 320 / 13.74 x 12.60	455 x 440 / 17.91 x 17.32
Permissible load per rack	Kg / lbs	20 / 44	20 / 44	20 / 44
Permissible total load	Kg / lbs	35 / 77	45 / 99	65 / 143
Weight				
Weight (empty)	Kg / lbs	63 / 139	95 / 209	153 / 337
Temperature data				
Temperature range approx. 15 °C / 27 °F above room temperature up to	°C / °F	200 / 392	200 / 392	200 / 392
Temperature fluctuation	± K	0.1	0.1	0.1
Temperature uniformity (variation)	at 100 °C / 212°F	± K	1.5	2
	at 200 °C / 392°F	± K	3	4.5
Heating up time	to 100 °C / 212°F	min	65	80
	to 200 °C / 392°F	min	100	115
Max. temperature of inner chamber surfaces	°C / °F	320 / 608	320 / 608	320 / 608
Vacuum data				
Vacuum connection with small flange	DN mm / inch	16 / 0.63	16 / 0.63	16 / 0.63
Measuring access port with small flange	DN mm / inch	16 / 0.63	16 / 0.63	16 / 0.63
Inert gas connection with flow-limiter Adapter with hose olive	∅ mm / inch	8 / 0.31	8 / 0.31	8 / 0.31
Permitted end vacuum	mbar / inHg	1x10 ⁻² / 0.0003	1x10 ⁻² / 0.0003	1x10 ⁻² / 0.0003
Leak rate	bar/h / inHg /h	1x10 ⁻² / 0.295	1x10 ⁻² / 0.295	1x10 ⁻² / 0.295
Classification of the explosion proof inner chamber (according to ATEX Directive 2014/34/EU)	 II -/3G c IIB T3-T1 Gc X			
Electrical data				
IP protection type according to EN 60529	IP	54	54	54
Nominal voltage (±10%)	at 50 Hz power frequency	V	230	230
	at 60 Hz power frequency	V	230	230
Current type		1N~	1N~	1N~
Nominal power	kW	0.80	1.20	1.90
Chamber fuse 5 x 20 mm / 250V / middle-time-lag (M)	Amp	10	10	10
Power plug	shock proof plug			
Power plug vacuum module (option)	shock proof plug			
Over-voltage category acc. to IEC 61010-1		II	II	II
Pollution degree acc. to IEC 61010-1		2	2	2
Environment-specific data				
Energy consumption	at 100 °C / 212°F	Wh/h	105	150
	at 200 °C / 392°F	Wh/h	280	445

All technical data is specified for unloaded chambers with standard equipment (with aluminum racks) at an ambient temperature of $+22\text{ °C} \pm 3\text{ °C} / 71.6\text{ °F} \pm 5.4\text{ °F}$ and a power supply voltage fluctuation of ± 10 . Technical data is determined in accordance to BINDER Factory Standard Part 1:2015 following DIN 12880:2007.

All indications are average values, typical for chambers produced in series. We reserve the right to change technical specifications at any time.

19.3 Equipment and options (extract)

	To operate the chamber, use only original BINDER accessories or accessories / components from third-party suppliers authorized by BINDER. The user is responsible for any risk arising from using unauthorized accessories.
---	---

Regular equipment
Microprocessor program controller RD3 with LED display
Safety device class 2 according to DIN 12880:2007
RS 422 printer and communication interface with adjustable printing intervals
Fine-dosing aeration valve
Inert gas connection with fine-dosing valve
Analog pressure display (manometer)
Pressure switch for heating release (at pressure $< 125 \pm 25\text{ mbar} / 3.69 \pm 0.74\text{ inHg}$)
Area for electrical equipment swept with compressed air or inert gas with monitoring of the minimum supply pressure
Measuring connection (DN 16), rear
Safety glass panel
Intelligent adaptation of the heating power by soft heating-up function (selectable on-off)

Options / accessories		
Expansion racks, aluminum or stainless steel 1.4571		
FKM door gasket (temperature resistant up to $200\text{ °C} / 392\text{ °F}$)		
Additional measuring channel for digital object temperature display with flexible Pt 100 temper. sensor		
Communication software APT-COM™ for logging and display of temperature data and networking up to 30 chambers with PC		
ATEX connection kits for pumps VP4 (MZ2C EX) or VP5 (MD4C EX) with various small flange parts		
Measuring access port vacuum 9 poles		
Vacuum module with chemical membrane pump VP4 (MZ2C EX) with separator and emission condenser, ready for connection		
• Ready to connect: Suction power	m^3/h	1.9
• End vacuum	$\text{mbar} / \text{inHg}$	12 / 0.35
• Electrical connection (50 Hz)	V	230 / 1 N~
Vacuum module with chemical membrane pump or VP5 (MD4C EX) with separator and emission condenser, ready for connection		
• Ready to connect: Suction power	m^3/h	3.7
• End vacuum	$\text{mbar} / \text{inHg}$	3 / 0.09
• Electrical connection (50 Hz)	V	230 / 1 N~
Factory calibration certificate		
Extension to factory calibration certificate (additional value)		
Calibration certificate of object temperature display		
Qualification folder		
Evaporating dish with rim, small or large		
Stable table on wheels with castors and locking brakes		

19.4 Accessories and spare parts (extract)

	<p>BINDER GmbH is responsible for the safety features of the chamber only, provided skilled electricians or qualified personnel authorized by BINDER perform all maintenance and repair, and if components relating to chamber safety are replaced in the event of failure with original spare parts. The user is responsible for any risks arising from using unauthorized accessories/components.</p>
---	---

Chamber size	23	53	115
Description	Art. No.		
Expansion rack aluminum	8009-0370	8009-0371	8009-0372
Expansion rack stainless steel	8009-0101	8009-0102	8009-0103
Door gasket silicon (temperature-resistant up to 200 °C / 392°F)	6005-0015	6005-0016	6005-0018
Door gasket FKM (temperature-resistant up to 200 °C / 392°F)	6005-0044	6005-0045	6005-0046
Chamber fuse 5x20 mm / 250V / 10 Amp semi time lag (M)	5006-0012	5006-0012	5006-0012
Safety glass panel	6012-0007	6012-0008	6012-0015
Rack holder	4005-0071	4005-0072	4005-0073
Housing of instrument panel	6002-0067	6002-0016	6002-0016

Description	Art. No.
Shielding of instrument panel	6002-0017
Universal centering ring	6009-0048
Straining ring	6009-0009
Blind flange	6009-0010
Handle	6002-0002
Thermostat class 2 30° / 86°F to 320 °C / 608°F	5006-0008
Turning knob for thermostat class 2	8009-0004
Temperature sensor Pt 100	5002-0007
Temperature sensor Pt 100 heating	5002-0025
Manometer	6013-0040
Program controller RD3	5014-0102
Power supply unit	5020-0026
Stable table on wheels with castors and locking brakes	9051-0018
Qualification folder	DL0090031
Evaporating dish, small	4022-0125
Evaporating dish, large	4022-0126
Neutral cleaning agent, 1 kg	1002-0016
Validation service	
Qualification folder IQ-OQ	8012-0859
Qualification folder IQ-OQ-PQ	8012-0948
Execution of IQ-OQ	DL420300
Execution of IQ-OQ-PQ	DL440500
Calibration service	
Calibration of temperature including certificate (1 measuring point)	DL300201
Spatial temperature measurement including certificate (9 measuring points)	DL300209
Spatial temperature measurement including certificate (18 measuring points)	DL300218
Spatial temperature measurement including certificate (27 measuring points)	DL300227

19.5 Dimensions VDL 23

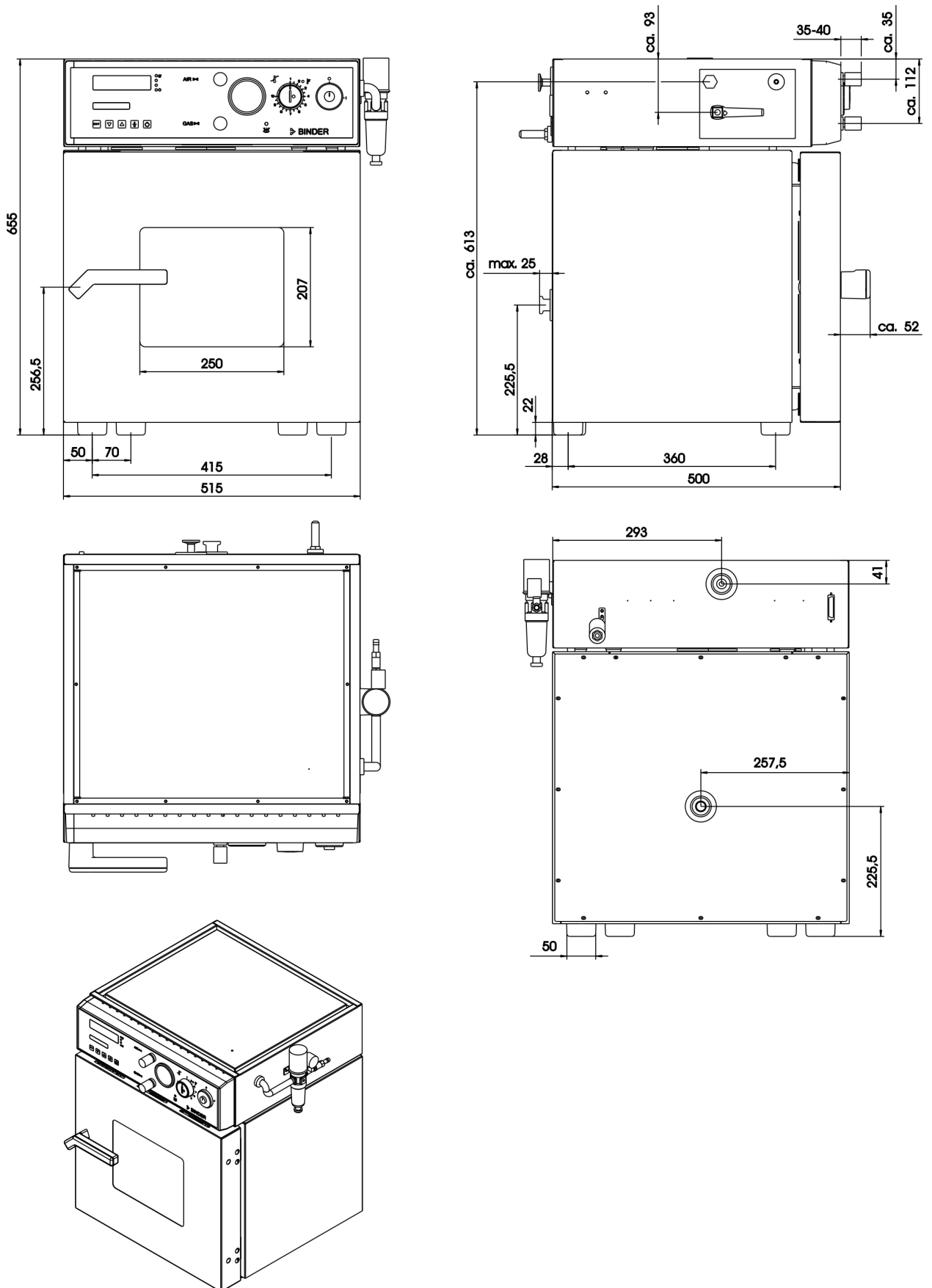

19.6 Dimensions VDL 53

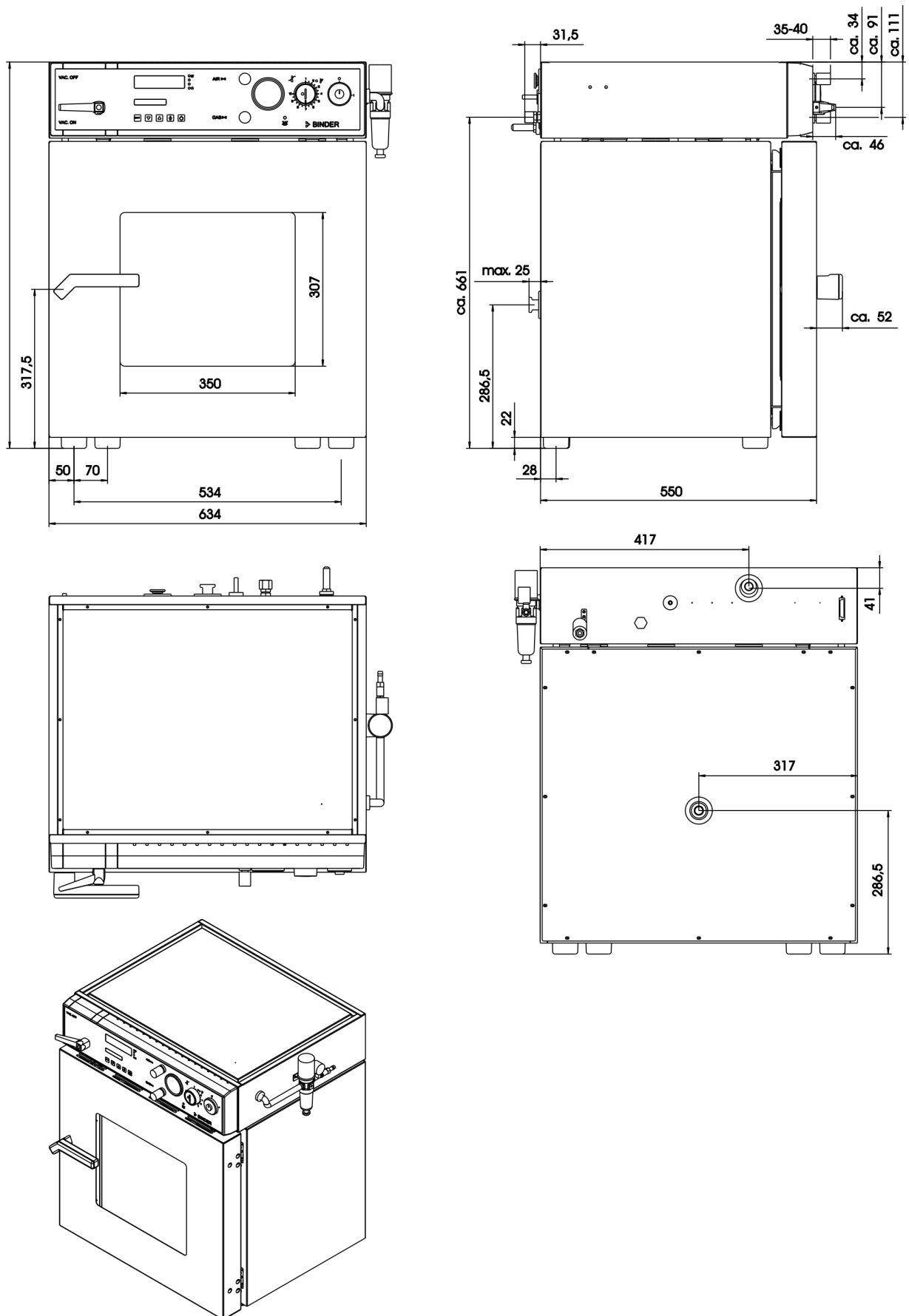

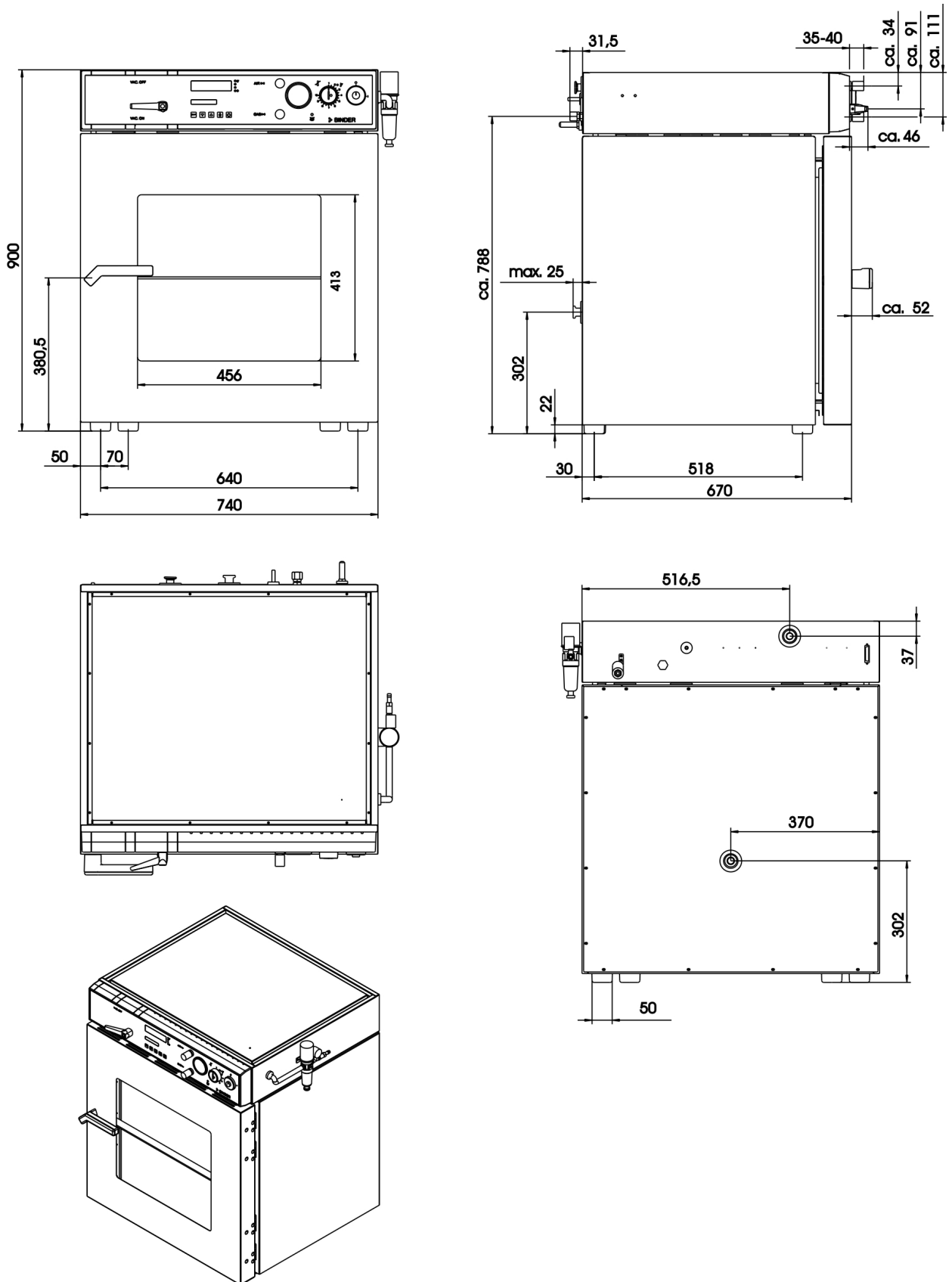

19.7 Dimensions VDL 115



20. Certificates and declarations of conformity

20.1 EU Declaration of Conformity

 Best conditions for your success

	EU-Konformitätserklärung / EU Declaration of Conformity / Déclaration de conformité UE / Declaración de conformidad UE / Dichiarazione di conformità UE / Декларация соответствия EU
Hersteller / Manufacturer / Fabricant / Fabricante / Fabricante / Производитель	BINDER GmbH
Anschrift / Address / Adresse / Dirección / Endereço / Адрес	Im Mittleren Ösch 5, 78532 Tuttlingen, Germany
Produkt / Product / Produit / Producto / Prodotto / Продукт	Vakuumtrockenschränke für entflammbare Lösungsmittel Vacuum drying ovens for flammable solvents Etuves de séchage à vide pour les solvants inflammables Estufas de secado al vacío para disolventes inflamables Stufe a vuoto per solventi infiammabili Вакуумные сушильные шкафы для воспламеняющихся растворителей
Typenbezeichnung / Type / Type / Tipo / Tipo / Тип	VDL 23, VDL 53, VDL 115

Die oben beschriebenen Produkte sind konform mit folgenden EU-Richtlinien:
 The products described above are in conformity with the following EU guidelines:
 Les produits décrits ci-dessus sont conformes aux directives UE suivantes:
 Los productos descritos arriba cumplen con las siguientes directivas de la UE:
 I prodotti sopra descritti sono conformi alle seguenti direttive UE:
 Продукты, указанные выше, полностью соответствуют следующим EU руководствам:

- **2014/35/EU**
 Niederspannungsrichtlinie 2014/35/EU / Low voltage directive 2014/35/EU / Directive basse tension 2014/35/UE / Directiva sobre baja tensión 2014/35/UE / Direttiva Bassa tensione 2014/35/UE / Директива по низкому напряжению 2014/35/EU
- **2014/30/EU**
 EMV-Richtlinie 2014/30/EU / EMC Directive 2014/30/EU / Directive CEM 2014/30/UE / Directiva CEM 2014/30/UE / Direttiva EMC 2014/30/UE / Директива ЭМС 2014/30/EU
- **2014/34/EU**
 ATEX-Richtlinie 2014/34/EU / ATEX Directive 2014/34/EU / Directive ATEX 2014/34/UE / Directiva ATEX 2014/34/UE / Direttiva ATEX 94/9/UE / Директива ATEX 2014/34/EU

Die oben beschriebenen Produkte tragen entsprechend die Kennzeichnung CE.
 The products described above, corresponding to this, bear the CE-mark.
 Les produits décrits ci-dessus, en correspondance, portent l'indication CE.
 Los productos descritos arriba, en conformidad, llevan la indicación CE.
 I prodotti sopra descritti, conformi a quanto sopra, portano il marchio CE.
 Данные продукты в соответствии с изложенным выше маркированы знаком CE.

1 / 3

BINDER GmbH Postfach 102 D-78502 Tuttlingen Address: BINDER GmbH Im Mittleren Ösch 5 78532 Tuttlingen Germany
 Contact: Phone: +49 (0) 74 62 / 20 05 - 0 | Fax: +49 (0) 74 62 / 20 05 - 100 | info@binder-world.com | www.binder-world.com
 Managing Director: Dipl.-Ing. Peter M. Binder | District court Stuttgart, HRB 727150 | Company head office: Tuttlingen Germany
 Payment Details: Kreissparkasse Tuttlingen Account no.: 2266 BAN: 643 500 70 | IBAN-Code: DE05643 500700 00002266 | SWIFT-Code: SOLA DE S1TUT
 \$-Account no. 2202 611 55 | IBAN-Code: DE7464350070 0220 261155 | SWIFT-Code: SOLA DE S1TUT
 Deutsche Bank Tuttlingen Account no.: 2 138 709 BAN: 653 700 75 | IBAN-Code: DE56653 70075 0213870900 | SWIFT-Code: DEUT DE SS603
 Recycling of old equipment according to WEEE-Reg.-no. DE 37004983

Die Ex-Klassifikation des Geräteinnenraums nach ATEX Richtlinie 2014/34/EU ist :

The Ex classification of the inner chamber according to ATEX Directive 2014/34/EU is :

La classification Ex de la chambre intérieure selon la Directive 2014/34/UE ATEX est :

La clasificación Ex de las cámaras interiores según la Directiva 2014/34/UE es:

La classificazione Ex dello spazio interno dell'apparecchio secondo la direttiva ATEX 2014/34/UE è:

Классификация Ex внутренней камеры в соответствии с Директивой ATEX 2014/34/EU –

 Ex II -/3G c IIB T3-T1 Gc X

Die Temperaturklasse des Geräteinnenraums nach EN 60079-14 ist abhängig von der Einstellung des Temperaturwählbegrenzers und kann **T1**, **T2** oder **T3** sein. Die Temperaturklasse des Gesamtgerätes entspricht der Temperaturklasse des Innenraums.

The temperature class of the inner chamber acc. to EN 60079-14 depends on the setting of the temperature safety device and can be **T1**, **T2** or **T3**. The temperature class of the entire unit is equal to the temperature class of the inner chamber.

La classe de température de la chambre intérieure selon EN 60079-14 dépend du réglage de la sécurité de surchauffe. Elle peut être **T1**, **T2** ou **T3**. La classe de température de l'appareil entier est égale à celle de la chambre intérieure.

La clase de temperatura de las cámara interior según la EN 60079-14:1996 depende del ajuste del limitador de selección de temperatura y puede ser **T1**, **T2** o **T3**. La clase de temperatura de todo el aparato depende de la clase de temperatura de la cámara interior.

La classe di temperatura dello spazio interno dell'apparecchio secondo EN 60079-14 dipende dalla impostazione di limitatore di sovratemperatura e può essere **T1** o **T2** o **T3**. La classe di temperatura dell'intero apparecchio corrisponde alla classe di temperatura dello spazio interno.

Класс температурной защиты внутренней камеры в соответствии с EN 60079-14 зависит от устройства температурной защиты и может быть **T1**, **T2** or **T3**. Температурный класс защиты всего прибора соответствует температурному классу внутренней камеры.

Die oben beschriebenen Produkte sind konform mit folgenden harmonisierten Normen:

The products described above are in conformity with the following harmonized standards:

Les produits décrits ci-dessus sont conformes aux normes harmonisées suivantes:

Los productos descritos arriba cumplen con las siguientes normas:

I prodotti sopra descritti sono conformi alle seguenti normative armonizzate:

Продукты, указанные выше, полностью соответствуют следующим стандартам:

Sicherheit / Safety / Sécurité / Seguridad / Sicurezza / Нормативы по безопасности
<ul style="list-style-type: none"> EN 61010-1:2010 EN 61010-2-010:2013
EMV / EMC / CEM / CEM / EMC / CEM / ЭМС
<ul style="list-style-type: none"> EN 61326-1:2014

Explosionsschutz / Explosion protection / Protection contre les explosions / Protección contra explosiones / Protezione contro le esplosioni / Взрывозащита

- EN 1127-1:2011
- EN 13463-1:2009
- EN 13463-5:2011

Zusätzlich für Geräte mit Option „Zusätzlicher Messkanal für digitale Objekttemperaturanzeige mit flexiblem Pt 100 Temperaturfühler“ :

In addition for units with option "Additional measuring channel for digital object temperature display with flexible Pt 100 temperature sensor" :

En outre, pour les appareils avec l'option « Canal de mesure additionnel pour l'affichage de la température de l'échantillon avec sonde de température flexible Pt100 » :

Adicionalmente, para equipos con la opción "Canal de medición adicional para la indicación digital de la temperatura objetiva con sensor de temperatura flexible Pt 100":

In aggiunta, per apparecchi con l'opzione "Ulteriore canale di misura per la visualizzazione su indicatore digitale della temperatura degli oggetti rilevata mediante la sonda termica flessibile Pt 100":

Дополнительно для камер с опцией „Дополнительный измерительный канал для цифрового дисплея температуры образца с гибким температурным датчиком Pt100“

- EN 60079-11:2012 Abschnitt / Section / Section / Sección / Parte / Глава 5.7

78532 Tuttlingen, 20.04.2016

BINDER GmbH



P. M. Binder
Geschäftsführender Gesellschafter
Managing Director
Directeur général
Director general
Direttore Generale
Директор



J. Bollaender
Leiter F & E
Director R & D
Chef de service R&D
Responsable I & D
Direttore R & D
Глава департамента R&D

3 / 3

20.2 TÜV Certificate

ZERTIFIKAT ◆ CERTIFICADO ◆ CERTIFICAT ◆ СЕРТИФИКАТ ◆ 認証証書 ◆ CERTIFICATE

 Product Service

ZERTIFIKAT

Nr. Z1 14 03 44086 009

Zertifikatsinhaber: **BINDER GmbH**
 Im Mittleren Ösch 5
 78532 Tuttlingen
 DEUTSCHLAND

**Produktions-
stätte(n):** 54801

Prüfzeichen:



Produkt: **Laborgeräte
(Vakuumtrockenschränke,
APT.line VDL-Series)**

Modell(e): **VDL 23, VDL 53, VDL 115**

Kenndaten:

	VDL 23	VDL 53	VDL 115
Nennspannung:	230 V	230 V	230 V
Nennstrom:	3.5 A	5.3 A	8.3 A
Nennfrequenz:	50 / 60 Hz	50 / 60 Hz	50 / 60
Nennleistung:	0.8 kW	1.2 kW	1.9 kW

Geprüft nach: EN 61010-1:2001
EN 61010-2-010:2003

Das Produkt wurde auf freiwilliger Basis auf die Einhaltung der grundlegenden Anforderungen geprüft und kann mit dem oben abgebildeten Prüfzeichen gekennzeichnet werden. Eine Veränderung der Darstellung des Prüfzeichens ist nicht erlaubt. Die Übertragung eines Zertifikates durch den Zertifikatsinhaber an Dritte ist unzulässig. Umseitige Hinweise sind zu beachten.

Prüfbericht Nr.: 028-713036397-000

Datum, 2014-03-31

Seite 1 von 1

 (Abdul Sabbagh)



A1 / 04-11

TÜV SÜD Product Service GmbH · Zertifizierstelle · Ridlerstraße 65 · 80339 München · Germany



21. Product registration

Online Product Registration

Register your BINDER now!

www.binder-world.com/register

The registration is free and takes just a few seconds

Advantages:

- ▶ Short response times if service is needed
- ▶ Fair prices when relocating or installing equipment
- ▶ Calibration as required at no charge in case of recalls
- ▶ Free information on news, product upgrades and accessories

Easy registered in 3 steps:



1. List serial number here:

-

2. Go online: www.binder-world.com/register

3. Register serial number

22. Contamination clearance certificate

Unbedenklichkeitsbescheinigung

22.1 For chambers located outside USA and Canada

Declaration with regard to safety and health

Erklärung zur Sicherheit and gesundheitlichen Unbedenklichkeit

The German Ordinance on Hazardous Substances (GefStofV), and the regulations regarding safety at the workplace, require that this form be filled out for all products that are returned to us, so that the safety and health of our employees can be warranted.

Die Sicherheit und Gesundheit unserer Mitarbeiter, die Gefahrstoffverordnung GefStofV und die Vorschriften zur Sicherheit am Arbeitsplatz machen es erforderlich, dass dieses Formblatt für alle Produkte, die an uns zurückgeschickt wird.

	In the absence of a completely filled out form, repair is not possible. Ohne Vorliegen des vollständig ausgefüllten Formblattes ist eine Reparatur nicht möglich.
---	--

- A completely filled out form should be transmitted by Fax (+49 (0) 7462 2005 93555) or by letter in advance to us, so that this information is available before the equipment/component part arrives. A second copy of this form should accompany the equipment/component part. Eventually the carrier should be informed.

Eine vollständig ausgefüllte Kopie dieses Formblattes soll per Telefax (Nr. +49 (0) 7462 2005 93555) oder Brief vorab an uns gesandt werden, so dass die Information vorliegt, bevor das Gerät/Bauteil eintrifft. Eine weitere Kopie soll dem Gerät/Bauteil beigelegt sein. Ggf. ist auch die Spedition zu informieren.

- Incomplete information or non-conformity with this procedure will inevitably lead to substantial delays in processing. We hope you will have understanding for this measure, which lies outside of our area of influence, and that you will help us to speed up this procedure.

Unvollständige Angaben oder Nichteinhalten dieses Ablaufs führen zwangsläufig zu beträchtlichen Verzögerungen in der Abwicklung. Bitte haben Sie Verständnis für Maßnahmen, die außerhalb unserer Einflussmöglichkeiten liegen und helfen Sie mit, den Ablauf beschleunigen.

- **Please fill out this form completely.**

Bitte unbedingt vollständig ausfüllen!

1.	Unit/ component part / type: / Gerät / Bauteil / Typ:
2.	Serial No. / Serien-Nr.:
3.	Details about utilized substances / biological substances / Einzelheiten über die eingesetzten Substanzen/biologische Materialien:
3.1	Designations / Bezeichnungen:
a)	_____
b)	_____
c)	_____
3.2	Safety measures required for handling these substances / Vorsichtsmaßnahmen beim Umgang mit diesen Stoffen:
a)	_____
b)	_____
c)	_____

3.3	Measures to be taken in case of skin contact or release into the atmosphere / Maßnahmen bei Personenkontakt oder Freisetzung:
a)	_____
b)	_____
c)	_____
d)	_____
3.4	Other important information that must be taken into account / Weitere zu beachtende und wichtige Informationen:
a)	_____
b)	_____
c)	_____
4.	Declaration on the risk of these substances (please checkmark the applicable items) / Erklärung zur Gefährlichkeit der Stoffe (bitte Zutreffendes ankreuzen) :
<input type="checkbox"/>	4.1 For non toxic, non radioactive, biologically harmless materials / für nicht giftige, nicht radioaktive, biologisch ungefährliche Stoffe: We herewith guarantee that the above-mentioned unit / component part... / Wir versichern, dass o.g. Gerät/Bauteil...
<input type="checkbox"/>	Has not been exposed to or contains any toxic or otherwise hazardous substances / weder giftige noch sonstige gefährliche Stoffe enthält oder solche anhaften.
<input type="checkbox"/>	That eventually generated reaction products are non-toxic and also do not represent a hazard / auch evtl. entstandene Reaktionsprodukte weder giftig sind noch sonst eine Gefährdung darstellen.
<input type="checkbox"/>	Eventual residues of hazardous substances have been removed / evtl. Rückstände von Gefahrstoffen entfernt wurden.
<input type="checkbox"/>	4.2 For toxic, radioactive, biologically harmful or hazardous substances, or any other hazardous materials / für giftige, radioaktive, biologisch bedenkliche bzw. gefährliche Stoffe oder anderweitig gefährliche Stoffe. We herewith guarantee that ... / Wir versichern, dass ...
<input type="checkbox"/>	The hazardous substances, which have come into contact with the above-mentioned equipment/component part, have been completely listed under item 3.1 and that all information in this regard is complete / die gefährlichen Stoffe, die mit dem o.g. Gerät/Bauteil in Kontakt kamen, in 3.1 aufgelistet sind und alle Angaben vollständig sind.
<input type="checkbox"/>	That the unit /component part has not been in contact with radioactivity / das Gerät/Bauteil nicht mit Radioaktivität in Berührung kam
5.	Kind of transport / transporter / Transportweg/Spediteur:
	Transport by (means and name of transport company, etc.) / Versendung durch (Name Spediteur o.ä.) _____ _____
	Date of dispatch to BINDER GmbH / Tag der Absendung an BINDER GmbH: _____ _____

We herewith declare that the following measures have been taken / Wir erklären, dass folgende Maßnahmen getroffen wurden:

- Hazardous substances were removed from the unit / component part, so that no hazard exists for corresponding persons in the handling or repair of these items / das Gerät/Bauteil wurde von Gefahrstoffen befreit, so dass bei Handhabung/Reparaturen für die betreffenden Person keinerlei Gefährdung besteht
- The unit was securely packaged and properly identified / das Gerät wurde sicher verpackt und vollständig gekennzeichnet.
- Information about the hazardousness of the shipment (if required) has been provided to the transporter / der Spediteur wurde (falls vorgeschrieben) über die Gefährlichkeit der Sendung informiert.

We herewith commit ourselves and guarantee that we will indemnify BINDER GmbH for all damages that are a consequence of incomplete or incorrect information provided by us, and that we will exempt BINDER GmbH from eventual damage claims by third parties. / Wir versichern, dass wir gegenüber BINDER für jeden Schaden, der durch unvollständige und unrichtige Angaben entsteht, haften und BINDER gegen eventuell entstehende Schadenansprüche Dritter freistellen.

We are aware that, in accordance with Article 823 of the German Civil Code (BGB), we are directly liable with regard to third parties, in this instance especially the employees of BINDER GmbH, who have been entrusted with the handling / repair of the unit / component. / Es ist uns bekannt, dass wir gegenüber Dritten – hier insbesondere mit der Handhabung/Reparatur des Geräts/des Bauteils betraute Mitarbeiter der Firma BINDER – gemäß §823 BGB direkt haften

Name: _____

Position: _____

Date / Datum: _____

Signature / Unterschrift: _____

Company stamp / Firmenstempel:



Equipment that is returned to the factory for repair must be accompanied by a completely filled out contamination clearance certificate. For service and maintenance works on site, such a contamination clearance certificate must be submitted to the service technician before the start of the works. No repair or maintenance of the equipment is possible, without a properly filled out contamination clearance certificate.

22.2 For chambers located in USA and Canada

Product Return Authorization Request

Please complete this form and the Customer Decontamination Declaration (next 2 pages) and attach the required pictures. E-mail to: IDL_SalesOrderProcessing_USA@binder-world.com

After we have received and reviewed the complete information we will decide on the issue of a RMA number. Please be aware that size specifications, voltage specifications as well as performance specifications are available on the internet at www.binder-world.us at any time.

Take notice of shipping laws and regulations.

	Please fill:	
Reason for return request	<input type="radio"/> Duplicate order	
	<input type="radio"/> Duplicate shipment	
	<input type="radio"/> Demo	<i>Page one completed by sales</i>
	<input type="radio"/> Power Plug / Voltage	115V / 230 V / 208 V / 240V
	<input type="radio"/> Size does not fit space	
	<input type="radio"/> Transport Damage	Shock watch tripped? (<i>pictures</i>)
	<input type="radio"/> Other (specify below)	

Is there a replacement PO?	<input type="radio"/> Yes <input type="radio"/> No	
<i>If yes -> PO #</i>		
<i>If yes -> Date PO placed</i>		
Purchase order number		
BINDER model number		
BINDER serial number		
Date unit was received		
Was the unit unboxed?	<input type="radio"/> Yes <input type="radio"/> No	
Was the unit plugged in?	<input type="radio"/> Yes <input type="radio"/> No	
Was the unit in operation?	<input type="radio"/> Yes <input type="radio"/> No	
<i>Pictures of unit attached?</i>	<input type="radio"/> Yes <input type="radio"/> No	Pictures have to be attached!
<i>Pictures of Packaging attached?</i>	<input type="radio"/> Yes <input type="radio"/> No	

	Customer Contact Information	Distributor Contact Information
Name		
Company		
Address		
Phone		
E-mail		

Customer (End User) Decontamination Declaration

Health and Hazard Safety declaration

To protect the health of our employees and the safety at the workplace, we require that this form is completed by the user for all products and parts that are returned to us. (Distributors or Service Organizations cannot sign this form)

	<p>NO RMA number will be issued without a completed form. Products or parts returned to our NY warehouse without a RMA number will be refused at the dock.</p>
---	--

A second copy of the completed form must be attached to the outside of the shipping box.

1.	Unit/ component part / type:
2.	Serial No.
3.	List any exposure to hazardous liquids, gasses or substances and radioactive material
3.1	List with MSDS sheets attached where available or needed (if there is not enough space available below, please attach a page):
a)	_____
b)	_____
c)	_____
3.2	Safety measures required for handling the list under 3.1
a)	_____
b)	_____
c)	_____
3.3	Measures to be taken in case of skin contact or release into the atmosphere:
a)	_____
b)	_____
c)	_____
d)	_____
3.4	Other important information that must be considered:
a)	_____
b)	_____
c)	_____

4. Declaration of Decontamination

For toxic, radioactive, biologically and chemically harmful or hazardous substances, or any other hazardous materials.

We hereby guarantee that

- 4.1 Any hazardous substances, which have come into contact with the above-mentioned equipment / component part, have been completely listed under item 3.1 and that all information in this regard is complete.
- 4.2 That the unit /component part has not been in contact with radioactivity
- 4.3 Any Hazardous substances were removed from the unit / component part, so that no hazard exists for a persons in the shipping, handling or repair of these returned unit
- 4.4 The unit was securely packaged in the original undamaged packaging and properly identified on the outside of the packaging material with the unit designation, the RMA number and a copy of this declaration.
- 4.5 Shipping laws and regulations have not been violated.

I hereby commit and guarantee that we will indemnify BINDER Inc. for all damages that are a consequence of incomplete or incorrect information provided by us, and that we will indemnify and hold harmless BINDER Inc. from eventual damage claims by third parties.

Name: _____

Position: _____

Company: _____

Address: _____

Phone #: _____

Email: _____

Date: _____

Signature: _____



Equipment returned to the NY warehouse for repair must be accompanied by a completed customer decontamination declaration. For service and maintenance works on site, such a customer decontamination declaration must be submitted to the service technician before the start of work. No repair or maintenance of the equipment is possible without a completed form.

